

Ultimate Double Hung Insert G2 Installation Instruction



Introduction

These instructions are applicable for the following window products:

- Ultimate Insert Double Hung G2 (UDHING2)
- Ultimate Insert Single Hung Insert G2 (USHING2)
- Ultimate Double Hung Insert Picture G2 (UDHINPG2)
- Ultimate Double Hung Insert Transom G2 (UDHINTRG2)

ABSTRACT: Please read these instructions in their entirety before beginning to install your Marvin window product. These installation instructions demonstrate the installation of a Marvin wood window in an existing wood frame construction using an industry approved water management system. For installation using other construction methods, such as remodeling, replacement, and recessed openings refer to “ASTM E2112, Standard Practice for Installation of Exterior Windows, Doors and Skylights,” for installation suggestions. Information for ASTM E2112 can be found on the ASTM website, www.astm.org.

For product specific issues, service instructions and other field service guides, refer to the Marvin Service Manual, visit our website at www.marvin.com, or contact your Marvin representative.

Regional standard practices, environmental conditions, and codes may vary and supersede the procedures contained within. The responsibility for compliance is yours: the installer, inspector, and owner(s).

The procedures within these instructions are consistent with those used in testing to achieve the advertised DP rating.

The English language version of this installation instruction is the official version and shall take precedence over any translation.

Installer and Builder Information

- Always provide a copy of these instructions for the current homeowner.
- Refer to the Technical Installation Specifications section for technical specifications regarding the installation of this product. These installation requirements as well as the details in the section must be followed to achieve the advertised design pressure (DP) rating of this product.
- It is the responsibility of the builder, installer, and subcontractors to protect the interior and exterior of windows or doors from contact with harsh chemical washes, construction material contamination and moisture. Damage to glazing, hardware, weather strip and cladding/wood can occur. Protect with painters tape and/or protective sheathing as required. Follow all guidelines regarding material use, preparation, personal safety and disposal.
- Contact your Marvin supplier if you have any questions regarding product and materials used in manufacturing or questions on replacement parts.
- Please refer to the PDF version of this instruction for further information regarding best practices installer and builder information, code, and other legal requirements. The PDF version is the official document of record.

After Market Products

Alterations to Marvin products including window films, insulating or reflective interior window treatments or additional glazings can cause excessive heat buildup and/or condensation. They may lead to premature failures not covered under warranty by Marvin Windows and Doors.

Before purchasing or applying any product that may affect the installation or performance of Marvin windows or doors, contact the manufacturer of after market product/glazings that are not supplied by Marvin and request written product use, associated warranties and damage coverage. Provide this information and warranties to the end user and/or building owner for future reference.



WARNING!

This product can expose you to chemicals including titanium oxide, which is known to the state of California to cause cancer. For more information, go to www.P65Warnings.ca.gov.



WARNING!

Always practice safety! Wear the appropriate eye, ear, and hand protection, especially when working with power tools.



WARNING!

This product can expose you to chemicals including methanol, which is known to the state of California to cause birth defects or other reproductive harm. For more information, go to www.P65Warnings.ca.gov.

NOTE: Numbers listed in parentheses () are metric equivalents in millimeters rounded to the nearest whole number.



WARNING!

Drilling, sawing, sanding or machining wood products can expose you to wood dust, a substance known to the State of California to cause cancer. Avoid inhaling wood dust or use a dust mask or other safeguards for personal protection. For more information go to www.P65Warnings.ca.gov/wood.

Table of Contents

Removing the Old Sash and Preparing the Opening....	3
Exterior Installation - Preparing the Opening.....	4
Interior Installation - Preparing the Opening.....	4
Remove Packaging.....	5
Installing the Insert Window.....	6
Transom and Picture Units.....	8
Tilt Feature Operation.....	9
Removing the Operator Sash.....	10
Installing the Operator Sash.....	11
Lift Lock.....	12
Lift Lock Replacement.....	13
Hardware Removal.....	14
Removing the Screen.....	15
Installing the Screen.....	15

You Will Need to Supply

Tape measure	Level
Pry bar	Stiff putty knife
Utility knife	Fiberglass insulation
Stackable shims	Safety glasses
Reciprocating saw	Phillips screwdriver
Hand driver w/ T20 Torx™ head bit	
Power drill/driver w/ #2- 3/4" T20 Torx head bit	
Silicone sealant - grade NS Class 25 per ASTM C920 and compatible with building exterior and window surfaces.	

Replacement Parts

If replacement of parts ever becomes necessary, please contact your local Marvin Windows and Doors dealer.

Specifications and technical data are subject to change without notice. For information on parts and installation kits please refer to the Marvin Parts Manual.

Removing the Old Sash and Preparing the Opening

*NOTE: The UDHING2 Operators may be installed from either the interior or exterior. It is recommended that Pictures and Transoms be installed from the **INTERIOR** only. Procedures for both applications are covered in the following instructions.*

ATTENTION

If applicable, remove screen from insert prior to installation.

The following instruction detail the removal of sash and jamb hardware on windows that utilize a pulley and weight system. Your existing window may differ from those shown. All jamb hardware and/or jamb liners must be removed prior to installation of the UDHING2.

Exterior Installation - Preparing the Opening

1. Using a reciprocating saw, remove the jamb blind stop by cutting it even with head jamb blind stop and flush with exterior casing and jamb frame. See [Figure 1](#).



Figure 1

NOTE: Some existing window frames may require removal of the head jamb blind stop in order to properly insulate the cavity above the insert unit.

2. Lower the top sash and cut the balance cords. Remove the top sash, disconnect and remove any balance mechanisms attached to existing window frame.

3. Cut the balance cords on the lower sash and remove from frame. Remove any remaining balance mechanism hardware from the existing frame (such as balance cords, balance cord pulleys, etc.) that may hinder installation. If your frame utilized weight pockets

at the jambs, remove weights (if possible) and fill cavity with fiberglass insulation.



CAUTION!

Before proceeding, inspect existing frame for rot or deterioration of frame members. Repair or replace as needed.

4. Apply a 1/4" (6) bead of sealant at both sill to jamb joints and on the back of the interior sash stops or moulding. Apply a secondary continuous bead of sealant on sill. Proceed to Installing the Insert Window. See [Figure 2](#).

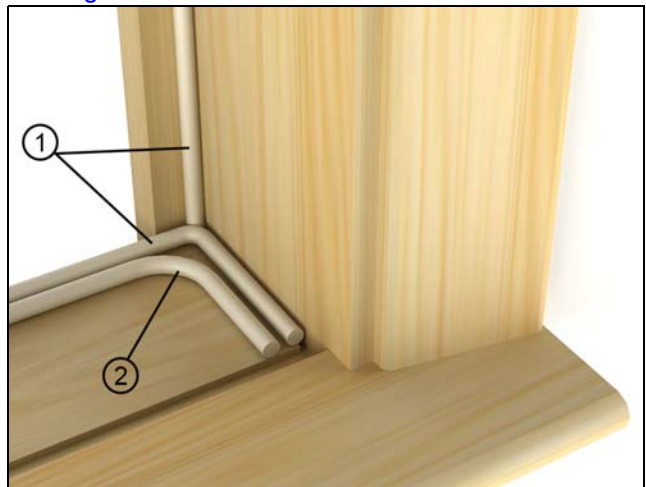

Figure 2

1 & 2	Sealant bead
-------	--------------

Interior Installation - Preparing the Opening

1. Remove all interior stops with a pry bar or stiff putty knife. See [Figure 3](#). Do not break or damage interior stops as they may be reused.



Figure 3

2. Cut balance cords on the lower sash and remove from frame.
3. Remove the parting stop from head jamb with a stiff putty knife or pry bar. Remove parting stops from both side jambs. See [Figure 4](#). Lower top sash and cut balance cords. Remove the top sash, disconnect and remove any balance mechanisms attached.

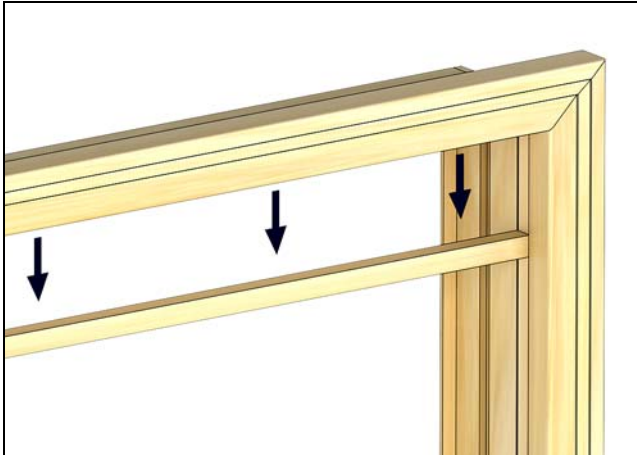

Figure 4

4. Remove any remaining balance mechanism hardware from the existing frame (such as balance cords, balance cored pulleys, etc.). If your frame utilized

weight pockets at the jambs, remove weights (if possible) and fill cavity with fiberglass insulation.

5. Apply a 1/4" (6) bead of sealant at both sill to jamb joints and on the back of the interior sash stops or moulding. Apply a secondary continuous bead of sealant on sill. Proceed to Installing the Insert Window. See [Figure 5](#).

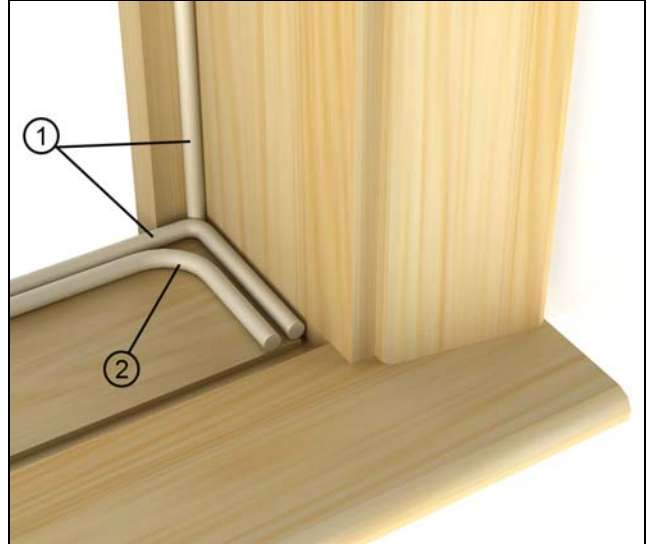

Figure 5

1 & 2	Sealant bead
-------	--------------

Remove Packaging

NOTE: Do not cut banding until unit is in the opening.

1. Remove exterior plastic wrap and cardboard protectors.
2. Remove shipping clips by pulling upward to release them. See [Figure 6](#).

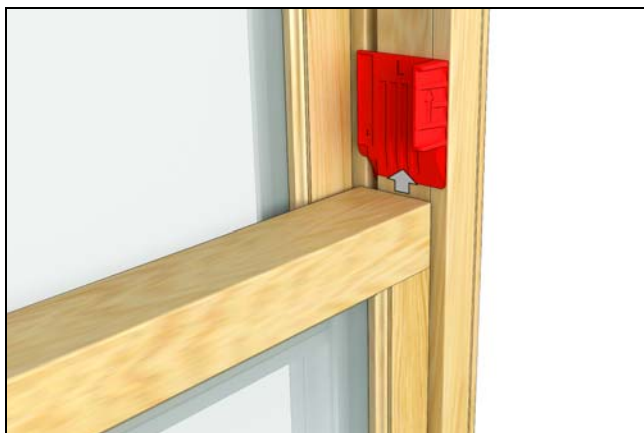

Figure 6

3. Rotate handle to 135° to unlock, then push center button to allow handle to rotate to 180° for tilting. See [Figure 7](#).

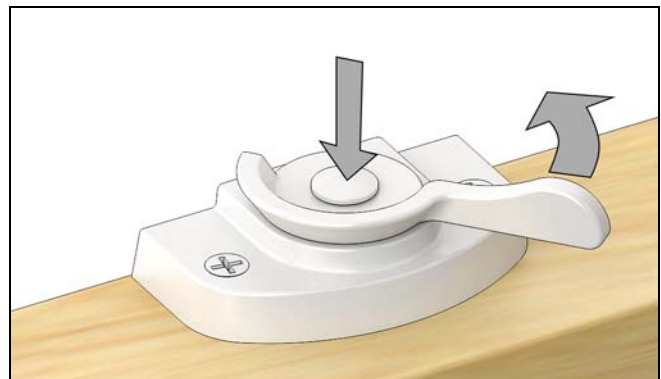

Figure 7

4. Tilt the sash out, then remove shipping tube assembly and tilt sash back into frame with center button depressed and handle rotated to 180°. See [Figure 8](#).



Figure 8

5. Raise bottom sash and remove foam blocks from sill. See [Figure 9](#).

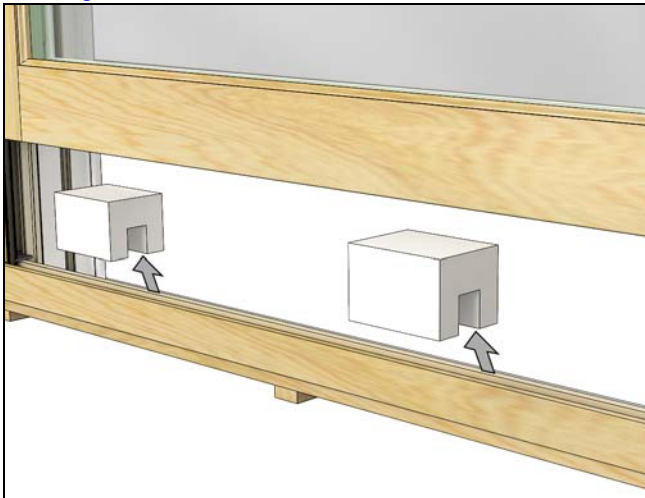

Figure 9

6. Inspect unit for any hidden damage and report immediately to your Marvin representative. Provide the customer service number etched on one of the top corners of the glass. See [Figure 10](#).

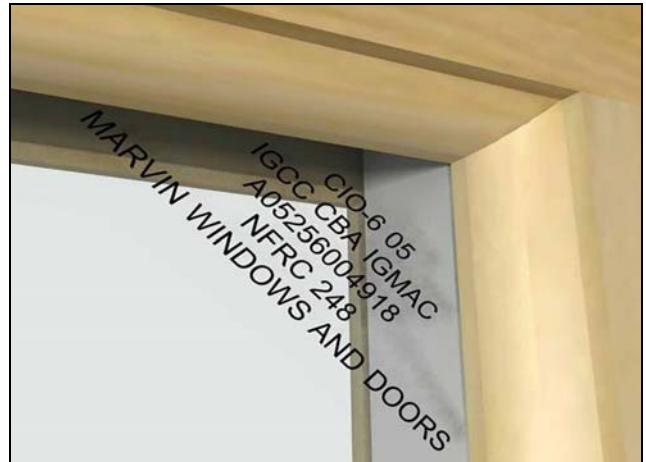

Figure 10

Installing the Insert Window

1. Before installing insert unit into opening, bend sill fin forward to the exterior. Sill fin is only needed if the gap is present between the existing sill and UDHING2 frame. See [Figure 11](#).

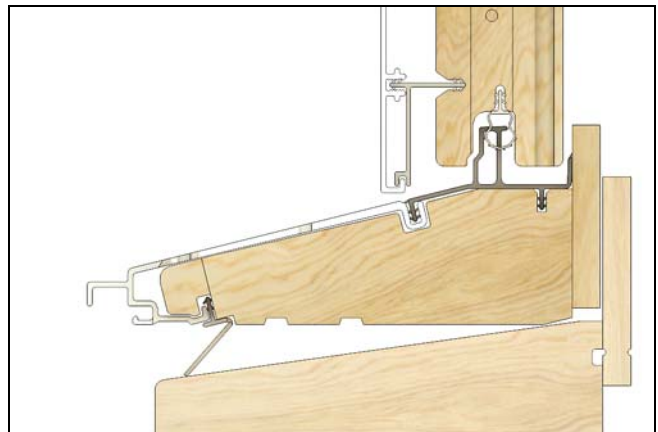

Figure 11

2. Center unit in opening. Depending on interior or exterior installation, press unit against interior sash stop or blind stop. *It is recommended that Picture and Transom units be installed from the interior only.* See [Figure 12](#)

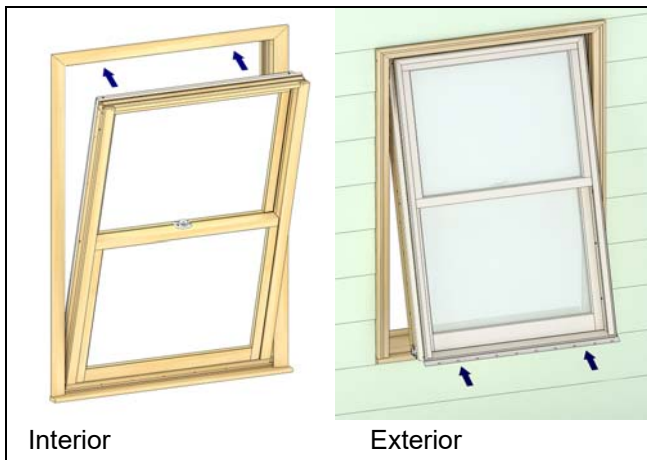

Figure 12

3. Remove the packaging bands on all jambs.

4. Tilt bottom sash. Remove the head jamb stop (labeled with a 1) and then remove all covers (labeled 2 and 3). If necessary place shims under sill of unit to level. Level unit horizontally from jamb to jamb at sill of unit. See [Figure 13](#). Units with a retractable screen will not have a tab.

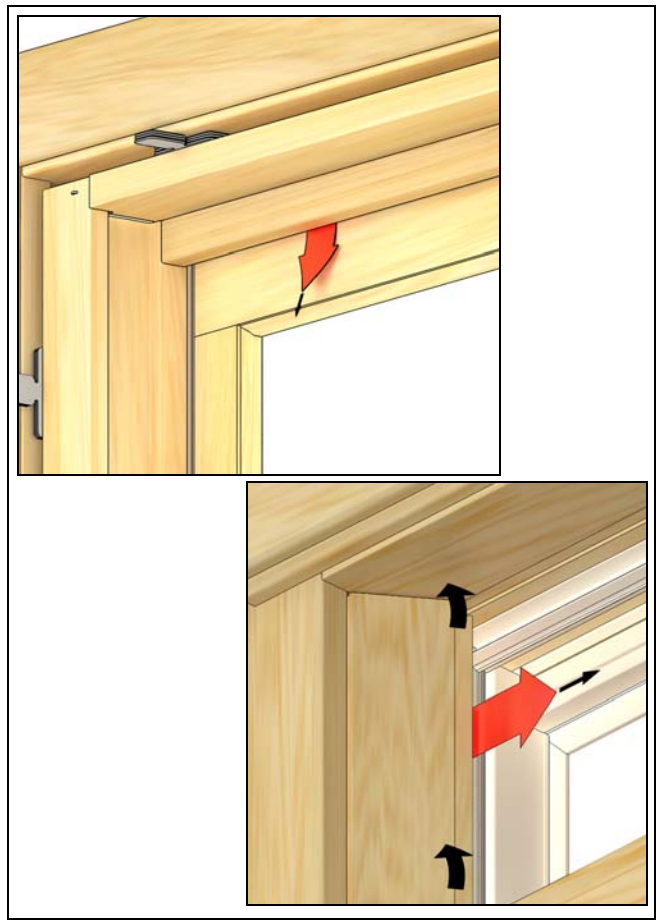

Figure 13

5. Place shims at all pre-drilled locations above the pre-drilled screw holes on upper and lower jambs. See [Figure 14](#).



Figure 14

6. Square frame by taking diagonal measurements. Measurements should be equal. Adjust shims as necessary to obtain frame squareness. See [Figure 15](#).

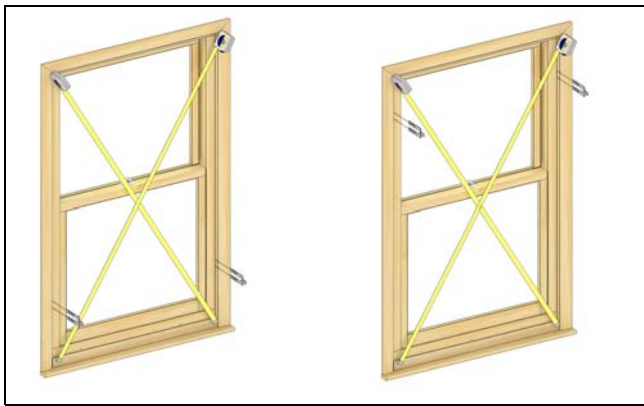

Figure 15

7. With bottom sash already tilted, lower the top sash slightly to access pre-drilled screw holes. When insert is square and plumb, hold unit firmly against blind stop or interior stop (depending on installation method), drive the four to eight - #8 x 3" T20 Torx pan head screws provided through pre-drilled holes in mid exterior cover and jamb wood. (Fastener quantity is dependent on size of the unit.) Do not over-tighten, some adjustment may be necessary later. See Figure 16.

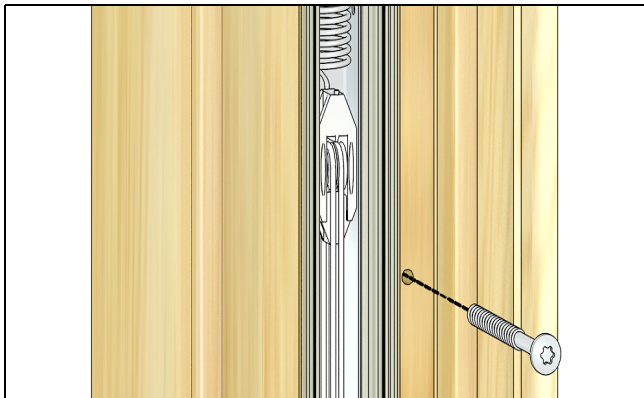

Figure 16

8. Measure width at head jamb, sill, and check rail. Jamb adjustment screws allow for adjustment to obtain an even reveal and proper sash operation. Using a hand drive T-20 driver, turn the jamb adjustment screw clockwise to move jambs away from the sash or counterclockwise to move jambs toward the sash. Adjust until measurements at head jamb, sill, and check rail are equal. See Figure 18.

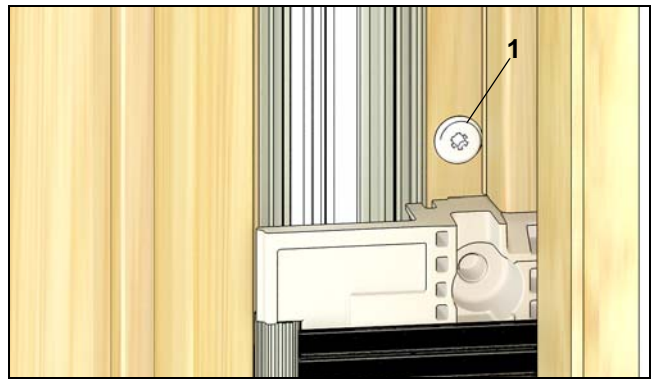

Figure 17

1	Jamb adjustment screw
---	-----------------------

9. Check diagonal measurements again. Adjust screws and shims as necessary to obtain frame squareness. Do not over shim. Drive a #8 x 3" Torx pan head screw into each jamb receiver hole. See Figure 18.



Figure 18

10. Run a bead of sealant between the insert frame and existing frame around the entire perimeter. If necessary, install backer rod prior to sealant. Replace interior sash stop or new trim as desired.

NOTE: Foam type insulation may be used to form an infiltration seal as required by some building codes. However, a low expansion type foam should be used in combination with fiberglass insulation.

NOTE: When using expanding foam insulation, it is very important not to bow the head jamb and/or side jambs of the insert unit.

Transom and Picture Units

1. Transom - Remove parting stop. Then remove wood jamb cover by using a tool or hooking screwdriver and inserting into notch at the top of each jamb cover. See Figure 19.

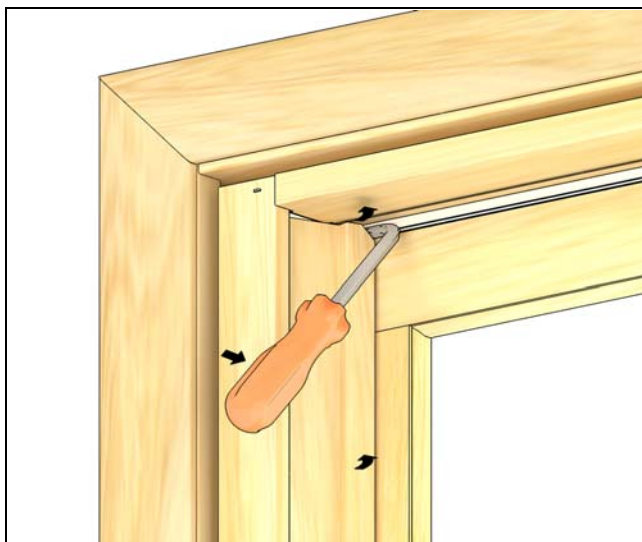

Figure 19

2. Insert #8 x 3" T20 Torx pan head into pre-drilled screw holes and tighten with a power driver/drill. Be sure shims are placed near every screw location to avoid bowing of jambs. Do not over-tighten screws. Check frame for squareness. Adjust as necessary by either loosening or tightening screws. See Figure 20.

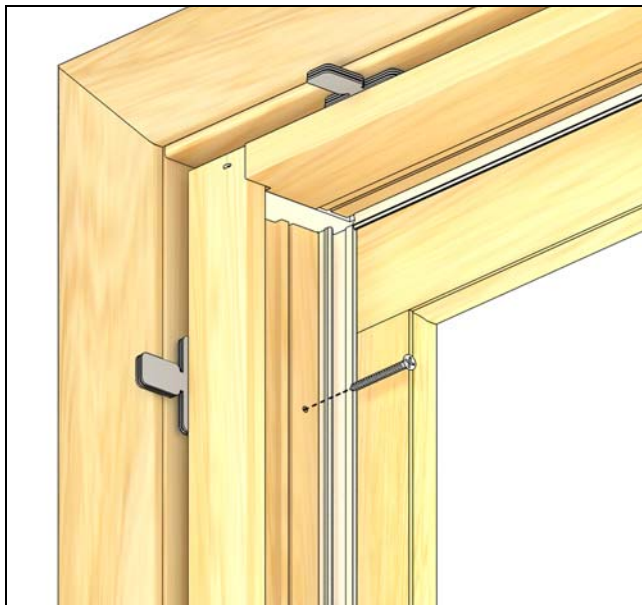

Figure 20

3. On picture and transom units, fasten unit in opening by inserting the #8 x 3" T20 Torx pan head screws (provided) into pre-drilled screw holes and tighten with a power driver/drill. Be sure shims are placed near every screw location to avoid bowing of jambs. Do not over-tighten screws. See Figure 21. Check frame for

squareness. Adjust as necessary by either loosening or tightening screws.

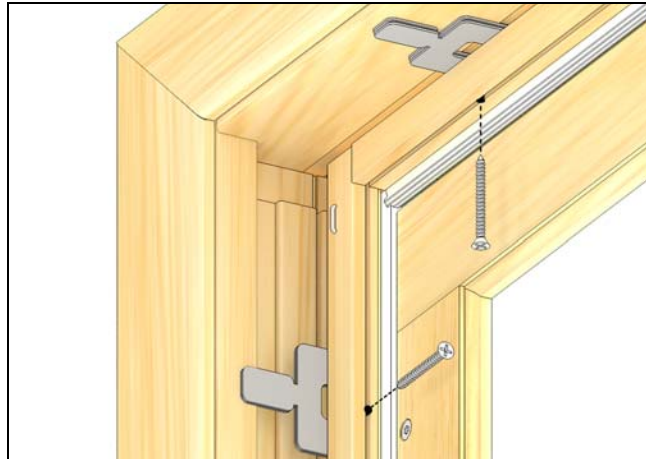

Figure 21

4. On picture units, install the interior sash stop by pressing the connecting barb into the jamb liner as shown in Figure 22. Start with the head jamb first, then the jamb. Measure width at head jamb and sill. Adjust shims as necessary.



Figure 22

5. Once the insert unit is flush, square, and plumb in opening, cut shims off flush with interior jamb or exterior of frame depending on installation technique. Fill the gaps between the insert window frame and existing window frame with fiberglass insulation. Do not pack tightly.

NOTE: Foam type insulation may be used to form an infiltration seal as required by some building codes. However, a low expansion type foam should be used in combination with fiberglass insulation.

NOTE: When using expanding foam insulation, it is very important not to bow the head jamb and/or side jambs of the insert unit.

Tilt Feature Operation

The UDHING2 is designed with a tilt feature that allows the consumer to wash the exterior of sash without removing sash from the frame.

NOTE: Only the bottom sash may be tilted on a Single Hung unit.

1. To tilt the bottom sash, simply raise sash about 4" (102). See Figure 23. Ease top edge of bottom sash out toward you to a horizontal position. The sash will pivot in the hardware near the bottom. Support top of tilted sash carefully with a stable support such as a padded step stool or chair to guard against damage or personal injury.



Figure 23

2. To tilt the top sash, lower top sash about 1/2 way. Pull the tilt latches (in the edge of sash top rail) until they release on each side. Hold latches until they clear unit frame when tilting. Ease top of sash toward you to horizontal position. See Figure 24.

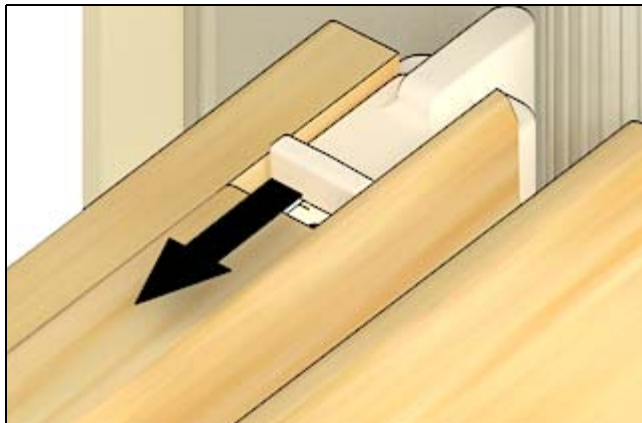

Figure 24

3. To tilt the top sash back to the original position, tilt upward and pull the tilt latches (in the top edge of sash top rail) until they retract fully on each side. Hold until sash is at installed position. Ease sash into jamb carrier track. Check the nose of each tilt latch to ensure they are fully engaged in the sash guide track of jamb carrier assembly.

Removing the Operator Sash

1. Raise bottom sash about 4" (102). Ease top edge of bottom sash out toward you to a horizontal position. The sash will pivot in the hardware near the bottom. Support top of tilted sash carefully with a stable support such as a padded step stool or chair to guard against damage or personal injury. See Figure 25.



Figure 25

2. Ease top of sash toward you to a horizontal position (flat). Lift both sides of the sash upward 2" - 3" (51-76) (raising pivot pins out of each clutch). See Figure 26.



Figure 26

3. Rotate the sash counterclockwise until pins clear the jambs and remove sash. See Figure 27

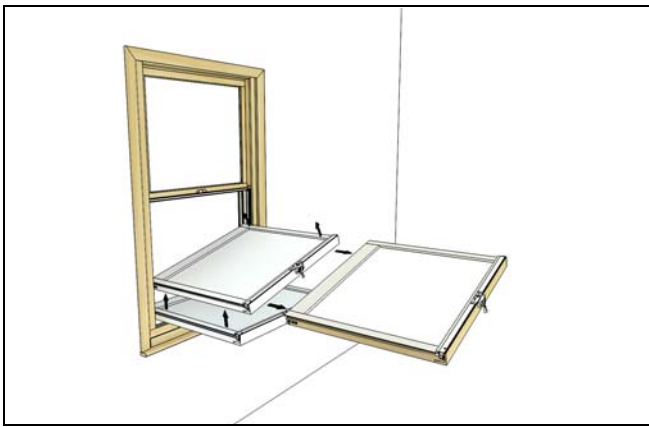

Figure 27

NOTE: The Single Hung top sash is not removable.

4. Lower top sash about 1/2 way. Pull the tilt latches (in the top edge of sash top rail) until they retract fully. Hold latches until they clear unit frame when tilting. See Figure 28.

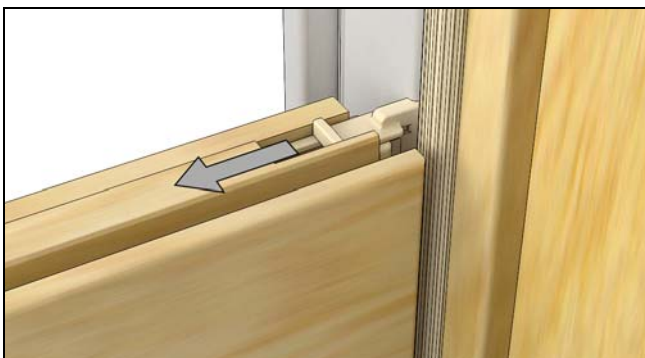

Figure 28

5. Ease top of sash toward you to a horizontal position (flat). Lift both sides of the sash upward 2"-3" (51-76) (raising pivot pins out of each clutch).

6. Rotate the sash counterclockwise until pins clear the jambs and remove sash. See Figure 29.

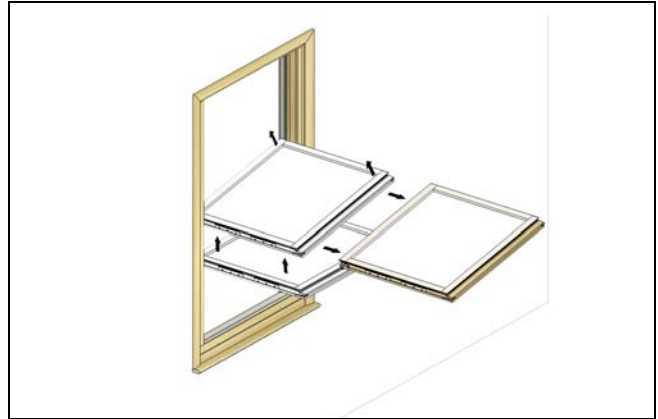

Figure 29

Installing the Operator Sash

! CAUTION!

When replacing sash, both sash pins must be positioned above the balance clutch assembly located in the jamb carrier track.

! CAUTION!

The clutches are under extreme spring tension.

NOTE: Should a balance clutch assembly slip upward toward the head jamb, the following procedures can be accomplished in order to properly reposition. Measure the clutch dimension from the sill for opposing balance assembly (must be within 1/8") and temporarily mark that dimension on the jamb carrier that contains the released clutch. Using a flat screwdriver, rotate the balance clutch cam in the clutch assembly to the released position. Hold the screwdriver firmly and slide the clutch assembly down the jamb carrier to the mark.

1. Rotate the balance clutch cam to the open locked position (cam opening up) See Figure 30. Release the screwdriver carefully from the clutch assembly (it must lock in place or damage will occur). Compare clutch heights from the sill for the sash affected. They must be within 1/8" (3) of each other or damage may occur when sash are reinstalled. Adjust height as needed.

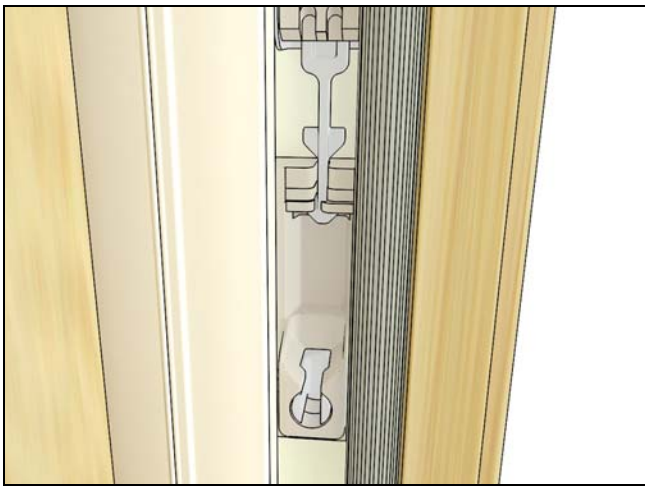

Figure 30

2. Hold the top sash in a horizontal position, top rail toward you, exterior face up. Sash pivot pins must be placed 2"-3" (51-72) above the clutch assemblies when relocating in jamb carrier tracks. Pivot one side of the sash up to enable pivot pins to clear jamb carrier assemblies when aligning sash in tracks, pivot sash back to horizontal (flat) position. Lower sash pivot pins into balance clutch cams. Check pins to ensure they are fully engaged in the clutch cams before proceeding. See Figure 31.

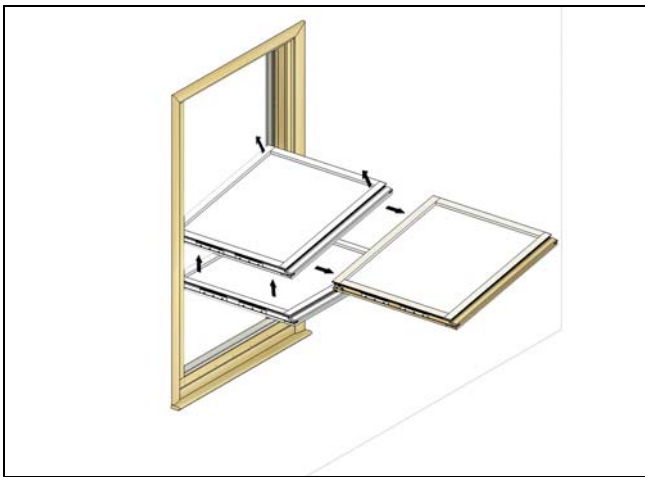

Figure 31

3. Tilt sash up, pull the tilt latches (in the top edge of sash top rail) until they retract fully on both sides, hold them and ease sash into place. See Figure 32. Check the nose of each tilt latch to ensure they are fully engaged in the sash guide track of jamb carrier assembly. Raise the top sash to the top of frame.

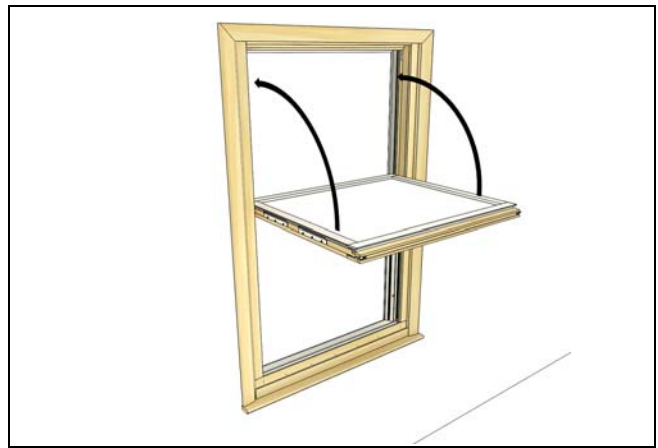

Figure 32

Lift Lock Operation

1. To unlock, lift up on the Lift Lock handle. See [Figure 33](#).

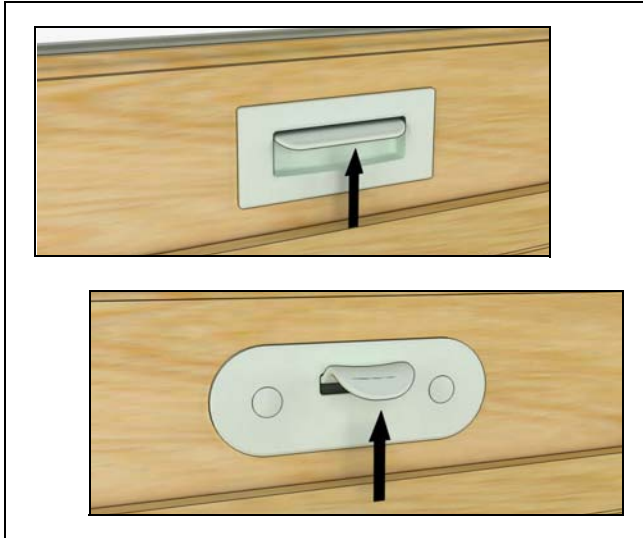

Figure 33

2. When sash is in unlocked and in lifted position, reach around top of check rail and slide manual tilt latches

toward middle of sash. To tilt, gently pull top of sash from window jamb. See [Figure 34](#).



Figure 34

Lift Lock Removal/Replacement

1. When sash is in unlocked and in lifted position, reach around top of check rail and slide manual tilt latches toward middle of sash. To tilt, gently pull top of sash from window jamb. See [Figure 35](#).



Figure 35

2. Remove escutcheon by placing a flat screwdriver in notch at the bottom between the escutcheon and plastic housing. Use a turning motion to release the escutcheon. See [Figure 36](#).

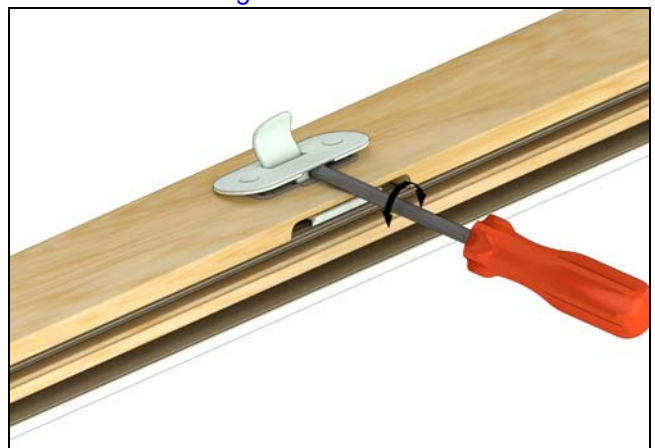

Figure 36

3. Remove the screws from the housing. See [Figure 37](#).

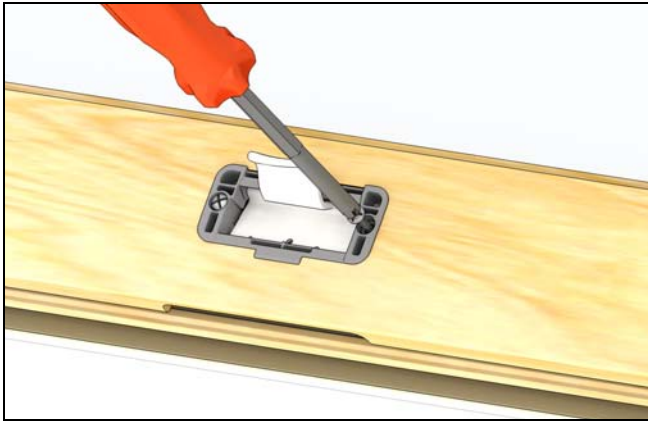

Figure 37

4. Place a putty knife between weather strip and latch. Gently pull Lift Lock at slight angle out of sash route. See [Figure 38](#).

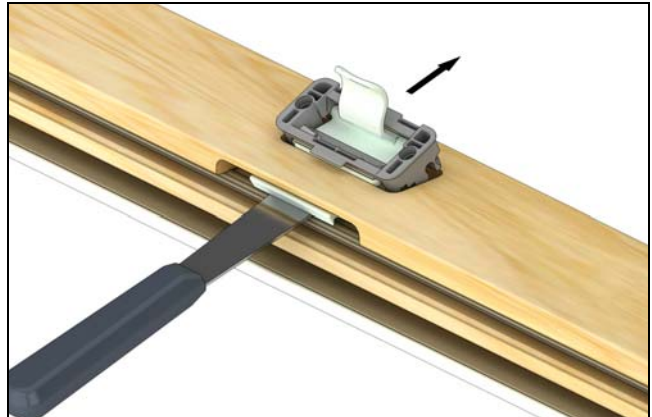

Figure 38

Hardware Removal

1. Unlock handle at 135°. See [Figure 39](#).



Figure 39

2. Remove both screws with a Phillips screwdriver. See [Figure 40](#).



Figure 40

3. Lift the lock off of the sash, finish as desired. See [Figure 41](#).

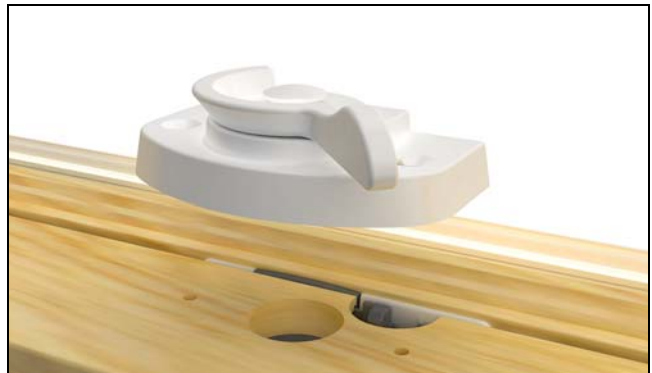

Figure 41

Removing the Screen

We suggest that you remove the operating sash (bottom sash only on Single Hung units) before attempting to remove the screen. Removing sash will allow easier removal of the screen.

NOTE: Unit is shipped with screen installed backwards to avoid shipping damage (plungers to the exterior). Screen should be installed with plungers to the interior for normal operation.

1. Grasp plunger bolts and pull inward. Push screen outward, grasp screen frame, pull down slightly. Turn screen sideways and bring into dwelling. [See Figure 42.](#)



Figure 42

Installing the Screen

1. When installing full screen, place screen sideways through window frame, turn to an upright position and place top plunger bolts against screen lip at head jamb. Pull screen towards the interior, holding plunger in the open position. When screen is flush against frame, release plungers to lock against screen lip.

2. When installing half screen, place screen sideways through window frame, turn to an upright position. Pull screen towards the interior, holding both plungers on one side in the open position. When screen is flush against blind stop, release plungers to lock into frame. [See Figure 43.](#)



Figure 43