



Elevate Sliding Patio Door DISC LA PRE 2/25/2019

Replacement Parts

Specifications and technical data are subject to change without notice.

Numbers listed in () parentheses are metric equivalents in millimeters rounded to the nearest whole number.

Suggested fasteners are not included and must be ordered separately.

Illustrations are not to scale.

Contents

Product History.....	2
Part Identification - Two Panel Operator.....	4
Part Identification - Three Panel Operator.....	5
Cambridge Handles.....	6
Northfield Handles.....	7
Handles - Discontinued No Availability (NA).....	8
Handle Parts.....	9
Handle Parts.....	10
Locking Hardware.....	11
Operators.....	12
Operators - Discontinued No Availability (NA).....	13
Miscellaneous Parts.....	14
Aluminum Parts.....	17
Aluminum Parts - Discontinued No Availability (NA).....	18
Vinyl Parts.....	19
Vinyl Parts - Discontinued No Availability (NA).....	22
Weather Strip: Blocks/Seals/Plugs.....	23
Weather Strip - Discontinued No Availability (NA).....	25
Wood Parts.....	26
Wood Parts - Discontinued No Availability (NA).....	29
Panel Replacement - Configured Part in OMS.....	30
Screen Replacement - Configured Part in OMS.....	31
Screen Parts.....	32
Screen Parts - Discontinued No Availability (NA).....	34

Produced	Unit Type	Features and Changes
1997	Patio Door	01/1997: Unit features 3/4" insulating Low E II tempered glass with Argon, mortise style locking system, stainless steel ball bearing twin roller operating system, exterior non-keyed handle and wood interior handle. Pultruded fiberglass (Ultrex) exterior available in white or pebble gray, oak sill liner and color matched top hung screen. Available in 5065, 6065 retro, 5068 and 6068 sizes. 07/1997: Added 9068 unit size to the product line available in XOO, OOX, or OXO configurations. Changed operator panel guide profile W7625, replaced with W7710. Changed head jamb liner profile W7624, replaced with W7709. Changed panel guide fastener profile V015, replaced with V016. Changed operator panel interlock weatherstrip height. 09/1997: Introduced white grilles-between-the-glass (GBG) simulated divided lite option. Direct glaze transoms offered for 6068 patio door. 10/1997: Elliptical Round Top transom offered for 6068 patio door.
1998	Patio Door	05/1998: Eliminated use of metal angle bracket to anchor the stationary panel to the sill. Redesigned leveling block end cap with a built in weep system. 11/1998: Introduced white hardware as an option for interior handle.
2000	Patio Door	12/2000: 6 13/16" jamb extension available factory applied. 5 5/16" jamb extension no longer available.
2001	Patio Door	03/2001: Added white interior finish. 04/2001: Interior handle change from wood to brass plated.
2002	Patio Door	02/04/2002: Stone White replacing Arctic White as a standard color. Arctic White replacement parts available through the warranty period. New profile for white screens, handle available through the warranty period. New profile uses existing roller bar (A213) and head jamb screen track (A214). 08/15/2002: Thumb turn design improved to eliminate excessive play.
2003	Patio Door	05/06/2003: Pebble and Stone White screens now both use new screen profile. A213 roller bar and A214 head jamb screen track now obsolete. Replaced with integral roller bar on panel and A1237 head jamb screen track. See Screen and Screen Parts section for more details. 11/24/2003: W7710 Panel Guide , W7709 Head Jamb Liner , and V016 Panel Guide Connector (replaced with new W8565 Head Jamb Liner, A1223 Aluminum Panel Guide Fastener, and W8566 Panel Guide.
2004	Sliding Patio Door	03/01/2004: Standard 6-0 door width changed from 73" opening to 72" opening.
2005	Sliding Patio Door	01/17/2005: Added two interior hardware finishes: White and Almond Frost, to interior handles.
2006	Sliding Patio Door	07/2006: SDL offered on all Elevate Series windows and doors. 7/8" wide bars with Ultrex exterior and wood interior. 09/2006: Prairie SDL and GBG Lite cuts made available for the Elevate Series windows and doors.
2007	Sliding Patio Door	03/2007: Added Bronze exteriors and Bronze handles. 11/2007: Added Evergreen exteriors.
2008	Sliding Patio Door	03/17/2008: Cashmere exteriors introduced. 07/2008: Cottage SDL lite cut made available.
2009	Sliding Patio Door	05/2009: LoE3 366 glass option introduced. 07/2009: Interior/Exterior Handle design change with AF as the default finish. Other finishes available are WH, BS PVD, SN PVD and ORBZ PVD.
2010	Sliding Patio Door	01/2010: Introduced new grille tack and installation tool and added to accessory chapter.
2011	Sliding Patio Door	02/2011: Introduced keyed option for complete handle sets.
2012	Sliding Patio Door	08/27/2012: Introduced Ebony exterior and exterior casing options.
2014	Sliding Patio Door	04/28/2014: Interior and Exterior Split Finish option became available so customers could choose different colors between exterior and interior handles. All current handle styles were given the name Cambridge. Handles are no longer available in sets. Introduced Special Size Door options. An addition of a CN 7-6 width option, available in 1/64" increments. 10/27/2014: Added Northfield hardware handle sets.
2017	Sliding Patio Door	12/18/2017: Added availability of customer specified divided lite cut configurations for SDL with and with out spacer and GBG. To include simulated check-rail and allow any color GBG to the exterior only of standard and special sized units.

Produced	Unit Type	Features and Changes
2018	Sliding Patio Door	05/2018: A213 roller bar and A214 are discontinued. All screen tracks can be replaced with the current Head Jamb Screen Track, A1237. 10/29/2018: Low E3 ERS glass type was added. 12/17/2018: Introduced textured glass types: Obscure, Reed, Narrow Reed, Rain, Glue Chip and Frost and also colored glass types: Clear, Bronze, Gray and Green.
2019	Sliding Patio Door	02/25/2019: Discontinued the sale of the Generation 2 Elevate Sliding Patio Door. 12/16/2019: Discontinued the sale of Wood Removable Grilles.

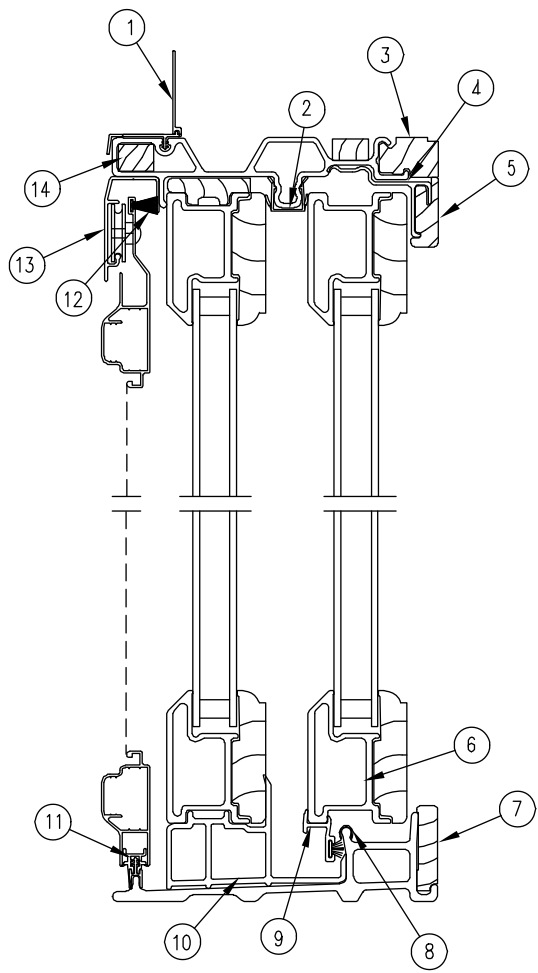

Head Jamb and Sill Detail

1. Head Jamb Nailing Fin w/Drip Cap, V119
2. Head Jamb/Stationary Jamb Parting Stop Weather Strip, V735
3. Head Jamb Liner, W8565
4. Aluminum Panel Guide Fastener, A1223
5. Operator Panel Guide, W8566
6. Adjustable Roller
7. Oak Sill Liner, W6275
8. Stainless Steel Sill Cap
9. Panel Drip Seal
10. Stationary Panel Leveling Block, V1171
11. Screen Roller Guide Assembly
12. Screen Roller Track Dust Block
13. Head Jamb Screen Track, A1237
14. Head Jamb Screw Backer
15. Jamb Liner, W7623
16. Interior Handle
17. Stationary/Operator Panel Interlock Pile Weather Strip
18. Interlock, Stationary/Operator, V009
19. Stationary Panel Spacer, W8581
20. Screen Frame Weather Strip
21. Exterior Handle
22. Operator Jamb Parting Stop Weather Strip, V011
23. Jamb Nailing Fin, V104

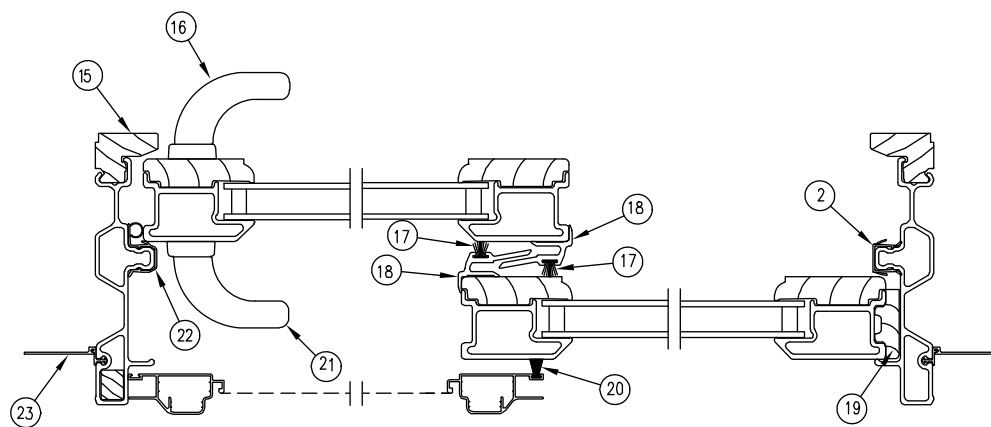

Jamb Detail - XO

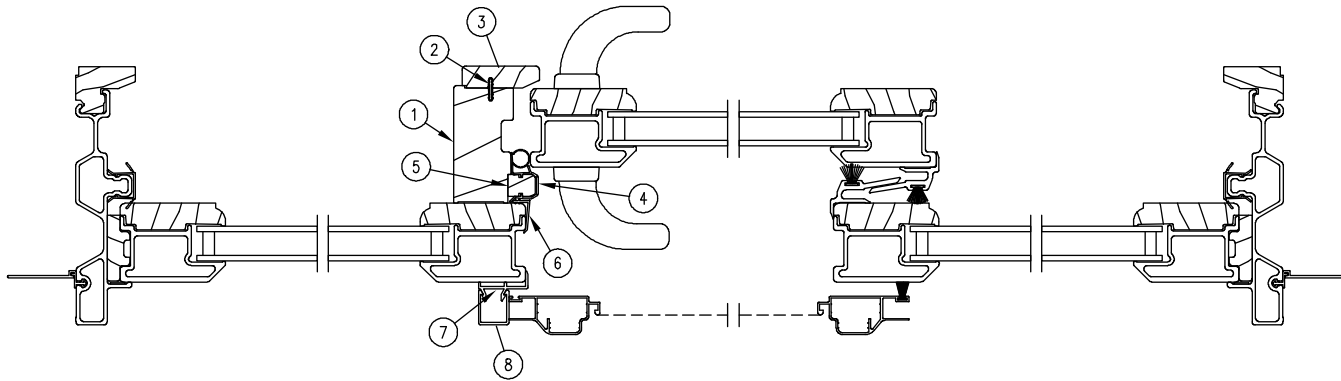

3 Panel Jamb Detail - OXO R

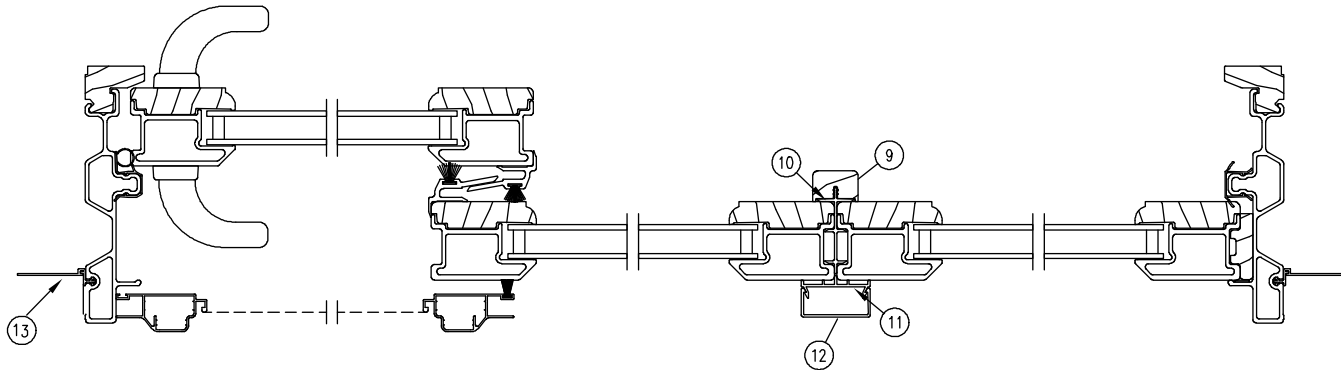

3 Panel Jamb Detail - XOO R

- | | |
|---|-----------------------------------|
| 1. Astragal, W7717 | 8. Screen Stop Astragal Cap, A361 |
| 2. Connecting Barb, V803 | 9. Interior Mull Trim, W7719 |
| 3. Astragal Trim, W7718 | 10. Panel Spline, V924 |
| 4. Operator Jamb Parting Stop Weather Strip, V011 | 11. Mull Cap Base, A363 |
| 5. Astragal Parting Stop, W7716 | 12. Mull Cap, A364 |
| 6. Astragal Stile Cap, V2649 | 13. Jamb Nailing Fin, V104 |
| 7. Screen Stop Astragal Base, A362 | |

Cambridge Handle Set, Exterior, Keyed

Includes:

- 1 - Exterior handle
- 1 - Keyed cylinder
- 2 - Keys
- 2 - Handle screws
- 1 - Exterior escutcheon

Color	PN
Almond Frost	11869066
White	11869067
Brass PVD	11869068
Satin Nickel PVD	11869069
Oil Rubbed Bronze PVD	11869070

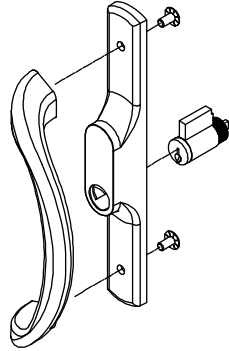

Cambridge Handle Set, Exterior, Non-Keyed

Includes:

- 1 - Exterior handle
- 2 - Handle screws
- 1 - Exterior escutcheon, non-keyed

Color	PN
Almond Frost	11869072
White	11869071
Brass PVD	11869073
Satin Nickel PVD	11869074
Oil Rubbed Bronze PVD	11869075

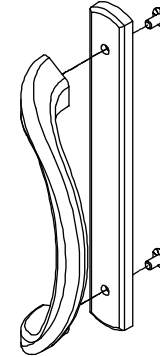

Cambridge Handle Set, Interior

Includes:

- 1 - Interior handle
- 1 - Interior escutcheon
- 1 - Thumb turn
- 1 - Keeper
- 2 - #8 x 2 1/2" Installation screws
- 2 - #8-32 Machine screws
- 2 - Handle screws
- 1 - Instruction

Color	PN
Almond Frost	11869061
White	11869062
Brass PVD	11869063
Satin Nickel PVD	11869064
Oil Rubbed Bronze PVD	11869065

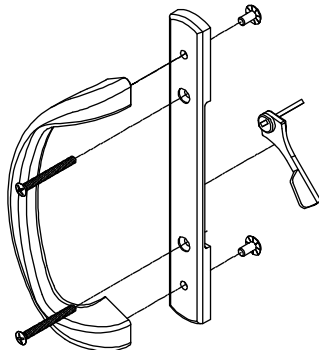

Northfield Handle Set, Exterior, Keyed

Includes:

- 1 - Exterior handle
- 1 - Keyed cylinder
- 2 - Keys
- 2 - Handle screws
- 1 - Exterior escutcheon

Color	PN
Almond Frost	11869090
White	11869091
Brass PVD	11869092
Satin Nickel PVD	11869093
Oil Rubbed Bronze PVD	11869094

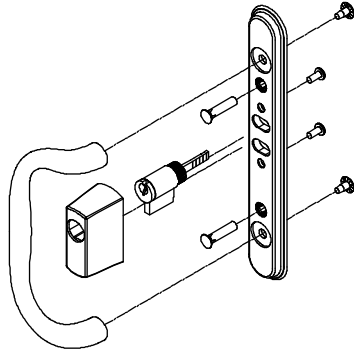

Northfield Handle Set, Exterior, Non-keyed

Includes:

- 1 - Exterior handle
- 2 - Handle screws
- 2 - Post nuts
- 1 - Exterior escutcheon, non-keyed

Color	PN
Almond Frost	11869096
White	11869095
Brass PVD	11869097
Satin Nickel PVD	11869098
Oil Rubbed Bronze PVD	11869099

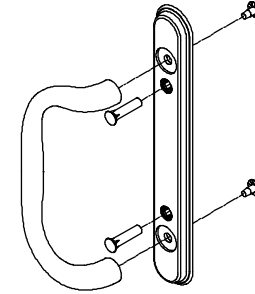

Northfield Handle Set, Interior

Includes:

- 1 - Interior handle
- 1 - Interior escutcheon
- 1 - Thumb turn
- 1 - Keeper
- 2 - #8 x 2 1/2" Installation screws
- 2 - #8-32 Machine screws
- 2 - Handle screws
- 1 - Instruction

Color	PN
Almond Frost	11869085
White	11869086
Brass PVD	11869087
Satin Nickel PVD	11869088
Oil Rubbed Bronze PVD	11869089

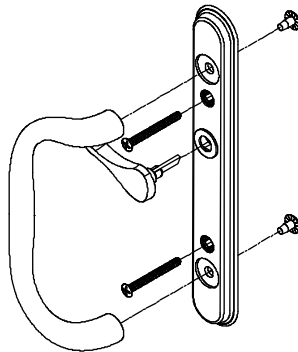

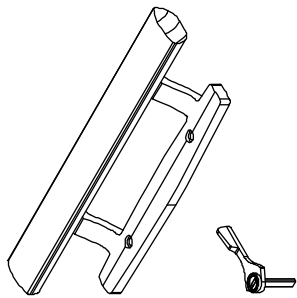

Interior Handle with Turn Lever
Used 01/1997 - 04/2001

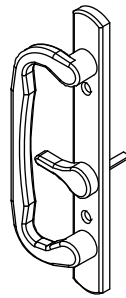

Interior Handle with Turn Lever
Used 03/2004 - 07/2009

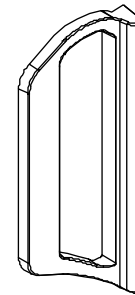

Exterior Pull Handle
Used 04/2001 - 07/2009

Keyed Cylinder

Includes:

- 1 - Lock Cylinder
- 2 - Keys

Note:

For keyed alike cylinders, please contact your Marvin representative. Please supply the original order number, if possible.

Cambridge PN	Northfield PN
11860975	11860973

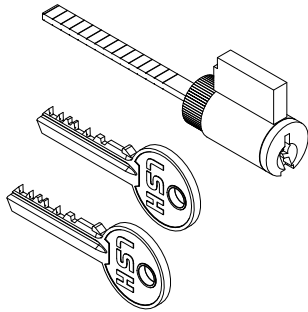

Cambridge Lock Lever

Color	PN
White	11897066
Almond Frost	11897067
Brass PVD	11897068
Satin Nickel PVD	11897069
Oil Rubbed Bronze PVD	11897070

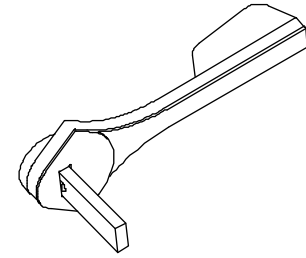

Cambridge Machine Screw

Includes:

1 - #8-32 x 2" Phillips oval head machine screw - attach exterior to interior plate

Color	PN
White	11897061
Almond Frost	11897062
Brass	11897063
Satin Nickel	11897064
Oil Rubbed Bronze	11897065

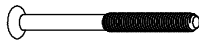

Northfield Machine Screw

Includes:

1 - #10 x 1 11/16" machine screw - attach exterior to interior plate

Color	PN
White	11895060
Almond Frost	11895061
Brass	11895062
Satin Nickel	11895064
Oil Rubbed Bronze	11895065

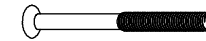

Handle Screw

Includes:

1 - #10-24 x 3/8" machine screw

Cambridge PN	Northfield PN
11895050	11895051

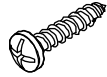

Northfield Escutcheon Post Nut

Color	PN
Almond Frost	11884041
White	11884040
Brass	11884042
Satin Nickel	11884043
Oil Rubbed Bronze	11884044

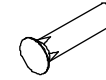

Keeper

PN
02100962

Suggested Fasteners		
Handing	Quantity/Description	PN
OX/XO, OOX/XOO	2 - #8 x 3" Phillips self tapping pan head screws	11800829
OXO	2 - #10 x 1" Phillips self tapping pan head screws	11801013

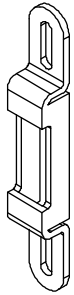

Mortise Lock

PN
02100960

Suggested Fasteners	
Quantity/Description	PN
2 - #8 x 1" Phillips self tapping pan head screws	11800810

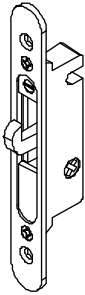

Adjustment Roller

Usage dates:

01/1997 to 02/25/2019

NOTE: Field Service Only

Color	PN
Zinc	10820010

Suggested Fasteners	
2 - #8 x 2", 410 screw	
Color	PN
Standard (Zinc)	11800868

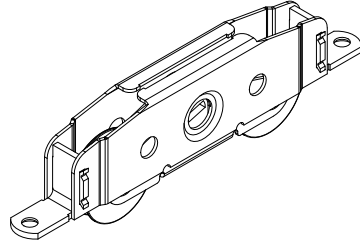

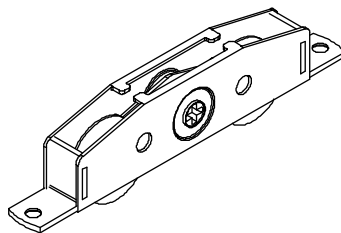

Adjustable Panel Roller

Usage dates: 01/1997 - 02/2019

No longer available, replace with 10820010

Stainless Steel Sill Cap

CN Width	Handing	Length	PN
5-0/7-6	OXO	58" (1473)	10500150
7-6	OOX/XOO	87 1/2" (2223)	10501153
6-0/9-0	OXO	70" (1778)	10500155
9-0	OOX/XOO	105 1/2" (2680)	10500192

Pre 03/01/2004 Door

CN Width	Handing	Length	PN
9-0	OOX/XOO	107" (1803)	10500190

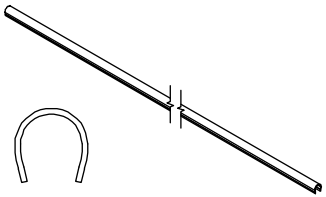

Leveling Block End Cap

Color	PN
Beige	10500131

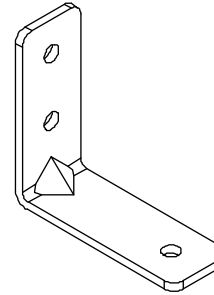

Sill Weep Cover and Flap

NOTE: Nylon

Color	PN
Beige	15633099

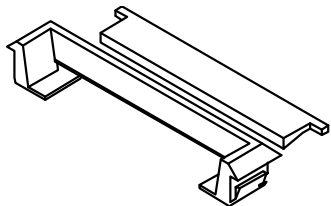

Sill Leveling Block End Cap

Handing	PN
XO	10500144
OX	10500145

Suggested Fastener	PN
1 - #8 x 1/2" Phillips stainless steel screw	11800516
1 - #8 x 1 1/2" Phillips pan head, full thread screw	11800766

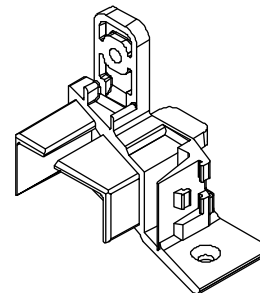

XO shown

Roller Adjustment Hole Cap

NOTE: 2 required for OOX/XOO configurations

Color	PN
Beige	11170001

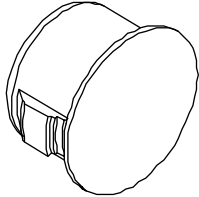

Door Stop

NOTE: or OOX/XOO configurations

PN
11872001

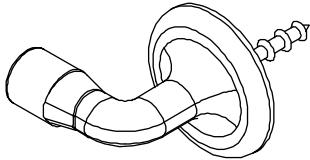

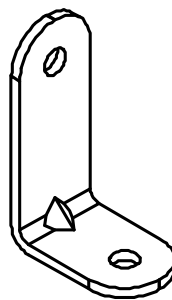

90 Degree Angle Bracket
Replace with 10500131

Aluminum Panel Guide

A1223

CN width	Length	PN
5-0	56 1/4" (1429)	18546050
6-0	68 1/4" (1734)	18546055
7-6 OOX/XOO	85 3/4" (2178)	18546092
7-6 OXO LH***	27 1/2" (699)	18546096
7-6 OXO RH***	27 1/2" (699)	18546080
9-0 OOX/XOO	103 3/4" (2635)	18546097
9-0 OXO LH**	33 1/2" (851)	18546093
9-0 OXO LH**	33 1/2" (851)	18546010
*Arctic White was the standard 1/1997 - 2/2002		
**Requires both the 9-0 OXO and the 6-0 part		
***Requires both the 7-6 OXO and the 5-0 part		

Suggested Fasteners	PN
7 - #8 x 5/8" Phillips trusshead screws	11800862

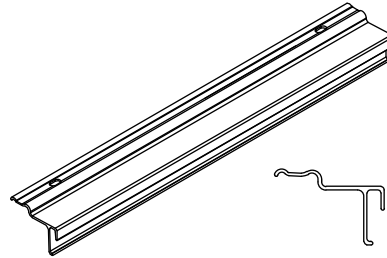

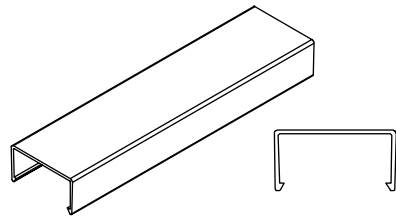

Mullion Cap, A364

Replace with A3337 Spline shown in the current Elevate Sliding Patio Door section. Use part numbers in the closest longer length.

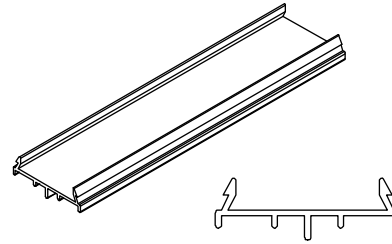

Mullion Cap Base, A363

Replace with A3337 Spline shown in the current Elevate Sliding Patio Door section. Use part numbers in the closest longer length.

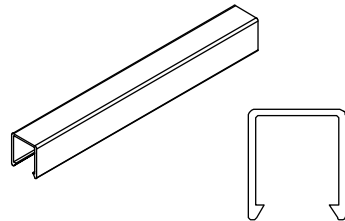

Screen Stop Astragal Cap, A361

Replace with A2222 Stile cover shown in the current Elevate Sliding Patio Door section. Use part numbers in the closest longer length.

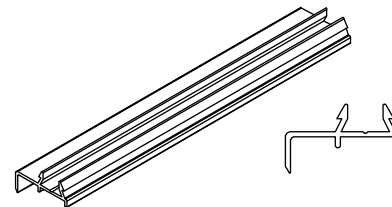

Screen Stop Astragal Base, A362

Replace with A3218 Sscreen Stop Base shown in the current Elevate Sliding Patio Door section. Use part numbers in the closest longer length.

Interlock, Stationary, (Option 1)

V009

NOTE: Pile Weather Strip is not included

NOTE: Adhesive tape included

CN Height	Length	Color	PN
6-5 XO	77 3/16" (1961)	Beige	15917665
6-5 OX			15917666
6-8 XO	79 11/16" (2024)		15917668
6-8 OX			15917669

Interlock, Operator, (Option 1)

V009

NOTE: Pile Weather Strip is not included

NOTE: Adhesive tape included

CN Height	Length	Color	PN
6-5 XO	77" (1956)	Beige	15916265
6-5 OX			15916266
6-8 XO	79 1/2" (2019)		15916268
6-8 OX			15916269

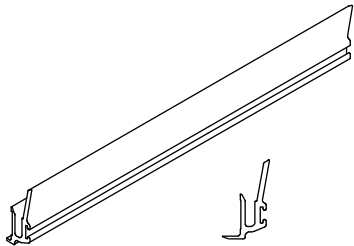

Interlock Replacement Kit, (Option 2)

Includes:

- 1 - V3189 Operator Interlock, CN80, Beige
- 1 - V3130 Stationary Interlock, CN80, Beige
- 16 - #8 x 1" Type-A, Phillips pan head screws
- 1 - Panel drip plug
- 2 - Sill dust block
- 1 - Interlock Retrofit Service Instruction

PN
116633

No Illustration Available

Panel Drip Seal

V010

NOTE: Weather strip included

CN Width	Length	Beige PN
5-0/7-6	29 5/8" (752)	15936350
6-0/9-0	35 5/8" (905)	15936355

Pre 03/01/2004 Door		
CN Width	Length	Beige PN
6-0/9-0	36 1/8" (918)	15916360

Suggested Fasteners	PN
6 - #7 x 1/2" Phillips self tapping pan head screws	11800756

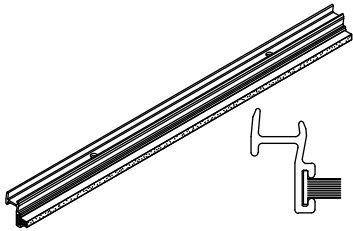

Stationary Panel Leveling Block

V008

NOTE: Adhesive tape included

CN Width	Operation	Length	PN
5-0/7-6	OXO	29 19/32" (752)	15916750
6-0/9-0	OXO	35 19/32" (904)	15916755
7-6	OOX/XOO	59 9/32" (1506)	15916776
9-0	OOX/XOO	71 9/32" (1811)	15916795

Suggested Fasteners	PN
1 - OX/XO (3 - OOX/XOO, OXO) #8 x 3/4" Truss head self tapping Almond Frost screws	11800833

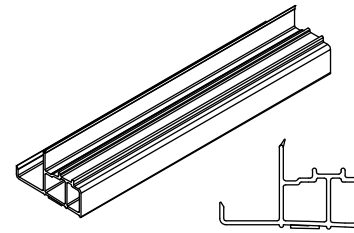

Astragal Stile Cap

V2649

NOTE: For OXO door configuration

Length	Color	PN
80 1/2" (2045)	Stone White	15910131
	Pebble	15910132
	Bronze	15910133
	Evergreen	15910134
	Cashmere	15910135
	Ebony	15910137
	Arctic White	NA*

*Order Stone White

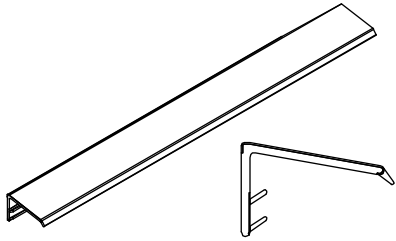

Jamb/Head Jamb Frame Weather Strip

V2396

Length	Beige PN
68 57/64" (1750)	15981160
78 11/16" (1999)	15977168
82 11/16" (2100)	15977170
114 25/64" (2906)	15978010

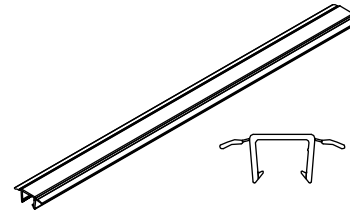

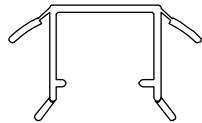

**Head Jamb/Stationary Jamb
Parting Stop Weather Strip, V735**

Replace with V2396. Use part numbers in the closest longer length.

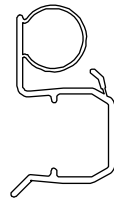

**Operator Jamb Parting Stop
Weather Strip, V011**

Replace with V2396. Use part numbers in the closest longer length.

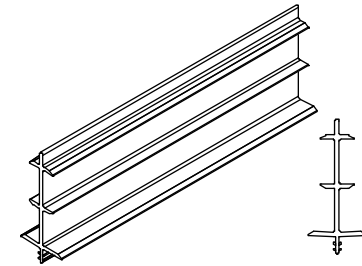

Panel Spline, V924

Replace with V2638 Spline
Insert shown in current
Elevate Sliding Patio Door
section. Use part numbers in
the closest longer length.

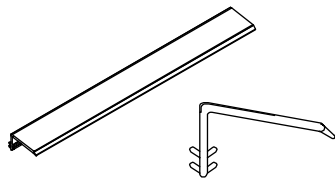

Astragal Stile Cap, V925

Replace with V2649 in
Stone White

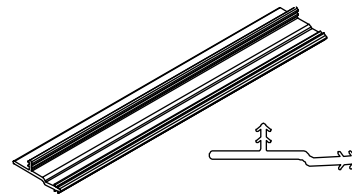

Panel Guide Connector, V016

Replace with A1223

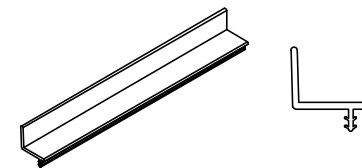

Panel Guide Fastener, V015

Replace with A1223

Frame Sealant, Foam, Sill Liner

1/16" x 3/8"

NOTE: Adhesive backed

Color	Length	PN
Gray	Specify LF	10500142

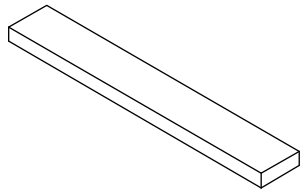

Sill Dust Block

2" x 13/16" x 5"

NOTE: Adhesive backed

Color	PN
Gray	10500132

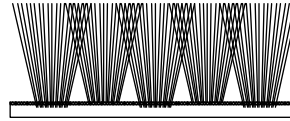

Head Jamb Dust Block

2 5/16" x 5/8" x 1/2"

NOTE: Adhesive backed

Color	PN
Gray	10500135



Jamb/Sill Plug

1 1/8" x 25/32" x 5/16"

NOTE: Adhesive backed

Color	PN
Beige	10500136

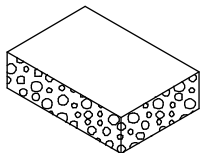

Panel Drip Weather Strip

17/64" x 1/4" pile weather strip with fin

Color	Length	PN
Gray	Specify LF	15607525

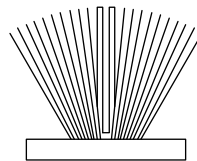

Stationary and Operator Panel Interlock Weather Strip

17/64" x 15/32" pile weather strip with fin

Color	Length	PN
Gray	Specify LF	11107546

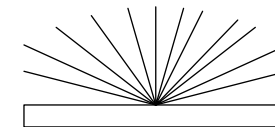

Panel Drip Plug

3/4" x 1 9/32" x 3/8"

NOTE: Adhesive backed

Color	PN
Gray	10500137

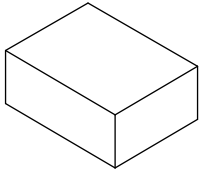

Astragal Plug

1" x 1/2" x 11/16"

NOTE: Adhesive backed

Color	PN
Gray	10500132

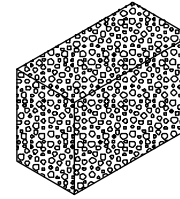

Head Jamb to Stationary Panel Foam Plug

Color	PN
Beige	10500128

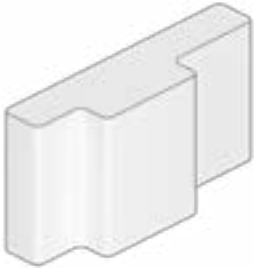

Sill to Jamb Gasket/Astragal Gasket

3/4" x 6 3/8" x 3/4" x 1/8"

NOTE: Adhesive backed

NOTE: Left and right hand supplied

NOTE: The adhesive backed astragal gasket is formed from the sill to jamb gasket by cutting the gasket to the dimensions shown in the illustration.

Color	PN
Beige	10500140

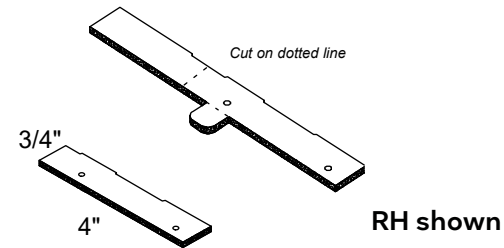

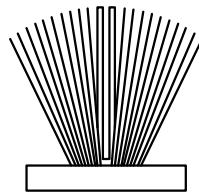

Operator Panel Interlock Weather Strip
Replace with 11107546

Panel Guide

W8566

Usage dates:

11/2003 to 02/25/2019

CN Width	Length	Bare Wood PN	White PN
5-0	56 3/8" (1432)	31518750	39228750
6-0	68 3/8" (1737)	31518755	39228755
7-6	86 1/2" (2197)	31518776	39228776
9-0	103 13/16" (2637)	31518792	39228792

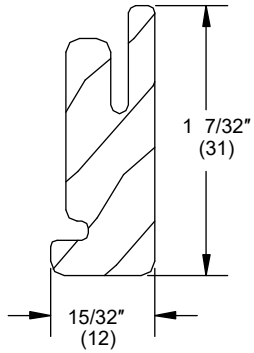

Stationary Panel Spacer

W8581

Length	Bare Wood PN
12" (305)	31518812



Head Jamb Liner

W8565

Usage dates:

11/2003 to 02/25/2019

CN Width	Length	Bare Wood PN	White PN
5-0	58 7/8" (1495)	31518650	39228650
6-0	70 7/8" (1800)	31518655	39228655
7-6	88 3/8" (2245)	31518676	39228676
9-0	106 3/8" (2702)	31518695	39228695
Replacement length	116 7/8" (2969)	31518610	39228676

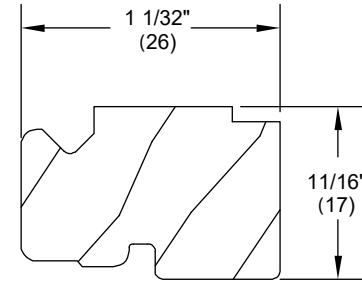

Astragal Trim

W7718

NOTE: Connecting barb (V803) included

CN Height	Length	Bare Wood PN	White PN
6-8 OXO	78 13/16" (2002)	31506568	39206568



Jamb Liner

W7623

NOTE: Handing is from the exterior

CN Height	Length	Bare Wood PN	White PN
6-5 RH	79 1/16" (2008)	31505365	39205365
6-5 LH		31505366	39205366
6-8 RH	81 9/16" (2072)	31505368	39205368
6-8 LH		31505369	39205369

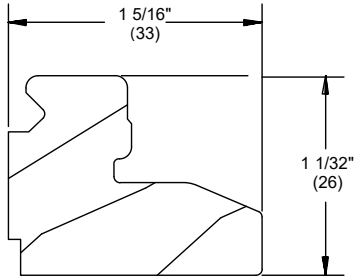

Interior Mull Trim

W7719

NOTE: For XOO or OOX configurations

CN Height	Length	Bare Wood PN	White PN
6-8	79 3/4" (2026)	31506668	39206668

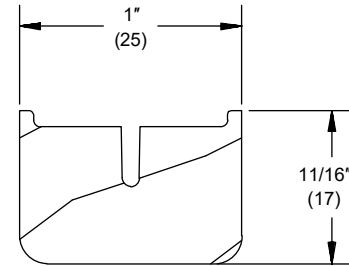

Astragal Assembly, OXO

Includes:

- 1 - Astragal
- 1 - Astragal cover
- 1 - Weather strip
- 1 - Top gasket
- 1 - Bottom gasket
- 1 - Bulb weather strip

NOTE: Replaces discontinued profiles W7716 and W7718

CN Height	Length	Bare Wood PN		White Interior PN	
		LH	RH	LH	RH
6-5	77 37/64" (1971)	10826503	10826504	10826501	10826502
6-8	80 5/64" (2034)	10826803	10826804	10826801	10826802

Suggested Fasteners	PN
9 - #8 x 3 1/2" screws	05080126

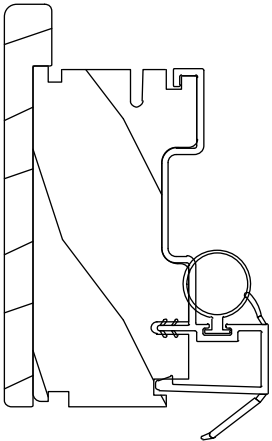

Oak Sill Liner

W6275

NOTE: Adhesive tape included

CN Width	Length	Bare Wood PN
5-0	58 7/8" (1495)	31505050
6-0	70 7/8" (1800)	31505055
7-6	88 3/8" (2245)	31505076
9-0	106 3/8" (2702)	31505095

Suggested Fasteners	PN
2 - #8 x 1 1/2" Phillips pan head, full thread screws	11800766
2 - #8 x 5/8" Phillips pan head screws	11800498

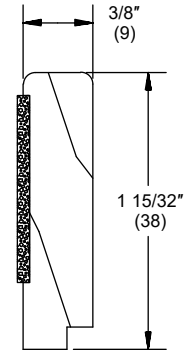

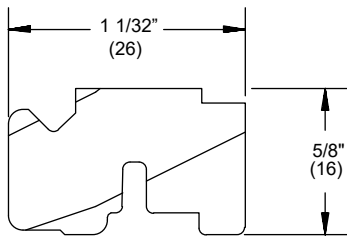

Head Jamb Liner, W7709
Replace with W8565

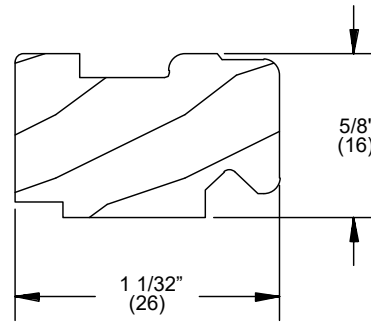

Head Jamb Liner, W7624
Replace with W8565

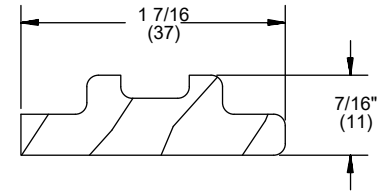

Stationary Panel Spacer, W7626
Replace with W8581

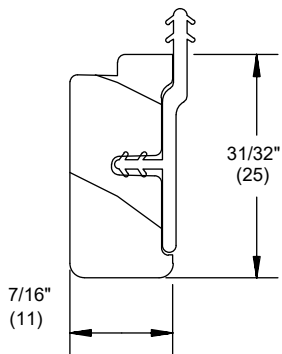

Operator Panel Guide, W7710
Replace with W8566

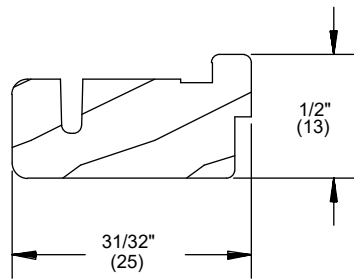

Operator Panel Guide W7625
Replace with W7710

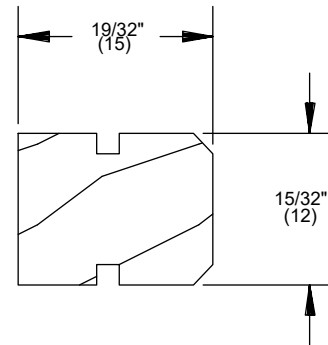

Astragal Parting Stop, W7716
Replace with the Astragal Assembly

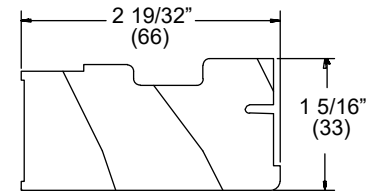

Astragal, W7717
Replace with the Astragal Assembly

Ordering specifications (use all that apply):

1. Size; (verify manufacture date before ordering)
2. Operator or stationary;
3. Handing;
4. Exterior color;
5. Glazing;
6. Bare wood or white interior

NOTE: Operator panels include rollers, panel drip with plug, and interlock. Stationary panels include interlock and panel spacers. The daylight opening is the measurement of visible glass.

NOTE: Panel is not reglazable; replacement glass will require a new panel.

Units manufactured 1997 - 03/01/2004

Daylight Opening (DLO) to Panel OM

Daylight Width + 4 5/8" (117) = OM Width of Panel

Daylight Height + 4 5/8" (117) = OM Height of Panel

Width	
CN Size	OM Width
5-0	29 5/8" (752)
6-0 retro	35 5/8" (905)
6-0/9-0	36 1/8" (918)
Height	
CN Size	OM Height
6-5	77 3/16" (1961)
6-8	79 11/16" (2024)

Units manufactured 03/01/2004 - 02/25/2019

Daylight Opening (DLO) to Panel OM

Daylight Width + 4 5/8" (117) = OM Width of Panel

Daylight Height + 4 5/8" (117) = OM Height of Panel

Width	
CN Size	OM Width
5-0/7-6	29 5/8" (752)
6-0/9-0	35 5/8" (905)
Height	
CN Size	OM Height
6-5	77 3/16" (1961)
6-8	79 11/16" (2024)

EXTERIOR VIEW

Sliding Patio Door

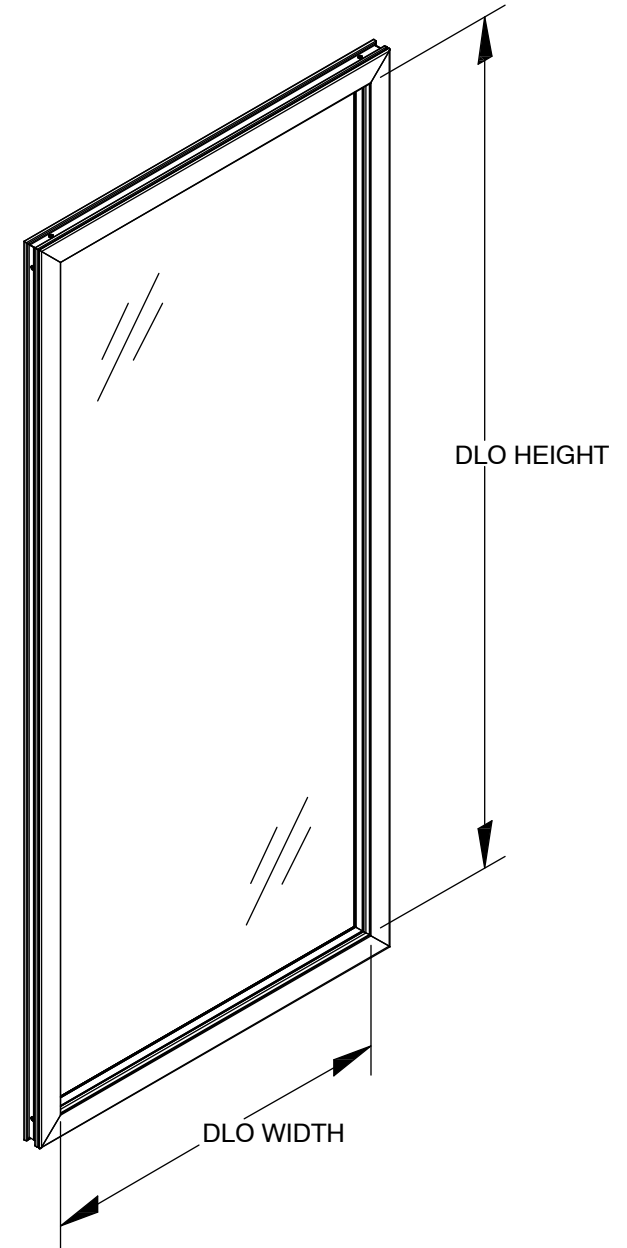

Ordering specifications (use all that apply):

- size; if there is no existing screen from which to obtain the OM of the screen, determine the size of the screen by using the conversion chart below. The daylight opening is the measurement of the visible glass;
- handing;

NOTE: Screens are standard with a color matched aluminum surround. Standard mesh is Marvin Bright View™. Determine the outside measurement of the existing screen. Find the sizes that correspond to the width and height indicated on the following chart.

Units manufactured 1997 - 05/05/2003

Daylight Opening (DLO) to OM of screen

Daylight Width + 4 3/16" (106) = OM Width of Screen

Daylight Height + 4 (106) = OM Height of Screen

Width	
CN Size	OM Width
5-0	29 3/16" (741)
6-0 retro	35 3/16" (894)
6-0/9-0	35 11/16" (906)
Height	
CN Size	OM Height
6-5	76 19/32" (1975)
6-8	79 3/32" (2038)

Units manufactured 03/01/2004 - 02/25/2019

Daylight Opening (DLO) to OM of screen

Daylight Width + 4 3/16" (106) = OM Width of Screen

Daylight Height + 5 3/16" (132) = OM Height of Screen

Width	
CN Size	OM Width
5-0/7-6	29 3/16" (741)
6-0/9-0	35 3/16" (894)
Height	
CN Size	OM Height
6-5	77 3/4" (1975)
6-8	80 1/4" (2038)

Units manufactured 05/05/2003 - 03/01/2004

Daylight Opening (DLO) to OM of screen

Daylight Width + 4 3/16" (106) = OM Width of Screen

Daylight Height + 5 3/16" (132) = OM Height of Screen

Width	
CN Size	OM Width
5-0	29 3/16" (741)
6-0 retro	35 3/16" (894)
6-0/9-0	35 11/16" (906)
Height	
CN Size	OM Height
6-5	77 3/4" (1975)
6-8	80 1/4" (2038)

ATTENTION: The Elevate Patio Door screen profile changed between February 2002 and May 2003.

- White screen profiles changed on 2/4/2002, along with a color change from Arctic White to Stone White. The roller bar (A213) and screen track (A214) were still used.
- On 5/6/2003 Stone White and Pebble screens changed to the new profile but use an integral roller bar instead of the old A213 roller bar and A214 screen track.
- All screen tracks can be replaced with the current head jamb screen track, A1237.
- Refer to illustrations below to identify screen type.

Pre 2/4/02



2/4/02 to 5/5/03



5/6/03 to Present



Head Jamb Screen Track

A1237

CN Width	Length	Color and Part Number					
		Stone White	Pebble	Bronze	Cashmere	Ebony	Evergreen
5-0/7-6 OXO	57 17/32" (1461)	11897145	11897146	11897147	11897149	11898150	11897148
6-0/9-0 OXO	69 17/32" (1766)	11897150	11897151	11897152	11897154	11898155	11897153
7-6 OOX/XOO	87 1/32" (2211)	10870476	10870576	10870676	10870867	10870967	10870767
9-0 OOX/XOO	105 1/32" (2668)	11897160	11897161	11897162	11897164	11898165	11897163

Suggested Fasteners	PN
6 - #8 x 5/8" Pierce point, Phillips, truss head screws	11800862

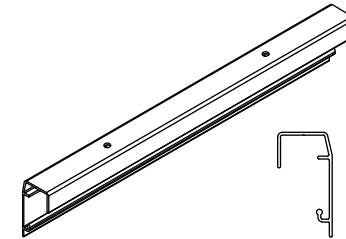

Screen Handle Assembly

Includes:

- 1 - Exterior handle - a
- 1 - Interior handle - b
- 1 - Slide - c
- 1 - Latch - d
- 3 - Screws
- 1 - Rivet

Color	PN
Black	10150028

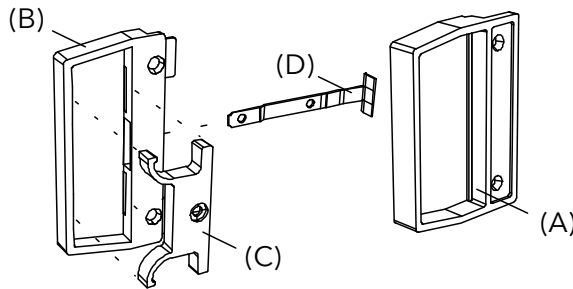

Bottom Rail Guide Bar

V552

Length	Black PN
74" (1880)	15660574

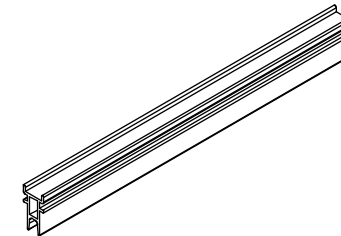

Screen Door Strike Kit

Includes:

1 - #8 x 5/8" Phillips pan head screw

PN
11897165

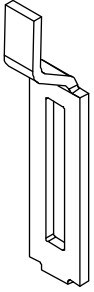

Screen Roller Assembly

Includes:

2 - Rollers
2 - Machine screws
2 - Grommet washers

PN
11869525

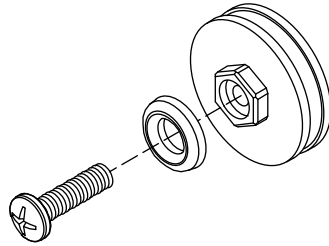

Screen Door Meeting Stile Dust Block

17/32" x 7/8" x 1/2" (13x22x13)

NOTE: Adhesive backed

Color	PN
Gray	10500161

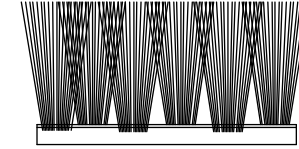

Screen Bumper

3/4" x 3/4" x 1 3/8"

PN
02540675

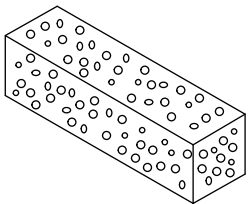

Screen Roller Track Dust Block

7/8" x 7/8" x 3/16"

NOTE: Adhesive backed

Color	PN
Gray	10500143



Screen Door Stop Kit

Includes:

2 - #8 x 5/8" pierce point, Phillips truss head screws

PN
10188177

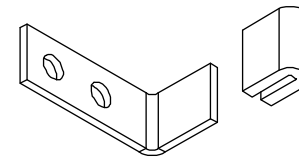

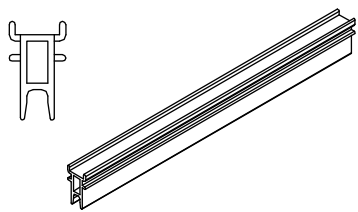

Screen Roller Guide, V014

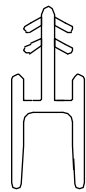

Screen Roller Guide, V2241

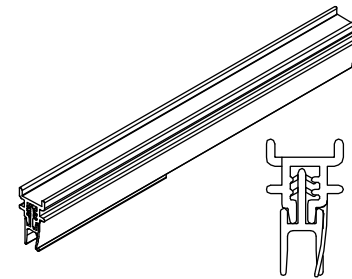

Screen Roller Guide Assembly
Replace with V552