



Elevate Inswing French Door

Contents

Replacement Parts

Specifications and technical data are subject to change without notice.

Numbers listed in () parentheses are metric equivalents in millimeters rounded to the nearest whole number.

Suggested fasteners are not included and must be ordered separately.

Illustrations are not to scale.

Product History.....	2
Part Identification - Two Panel Operator - XX.....	4
Part Identification - Two Panel Operator XO/OX.....	5
Part Identification - Single Panel Stationary O.....	6
Part Identification - Single Panel Operator X.....	7
Installation Parts.....	8
Handles.....	10
Hinge Handing Location.....	19
Hinges.....	20
Hinges - Discontinued Limited Availability (LA).....	21
Hinges - Discontinued No Availability (NA).....	22
Locking Hardware.....	23
Locking Hardware - Discontinued Limited Availability (LA).....	28
Miscellaneous Parts.....	32
Miscellaneous Parts - Discontinued Limited Availability (LA).....	33
Fasteners.....	34
Aluminum Parts.....	37
Aluminum Parts - Discontinued Limited Availability (LA).....	39
Vinyl Parts.....	40
Vinyl Parts - Discontinued Limited Availability (LA).....	41
Wood Parts - Discontinued No Availability (NA).....	43
Weather Strip.....	44
Weather Strip - Discontinued Limited Availability (LA).....	46
Weather Strip - Discontinued No Availability (NA).....	49
Panel Replacement - Configured Part in OMS.....	50
Panel Replacement - Discontinued Limited Availability (LA).....	51
Swinging Screen Replacement - Configured Part in OMS.....	52
Swinging Screen Parts.....	53
Swinging Screen Replacement - Disc Limited Availability (LA).....	58
Swinging Screen Parts - Discontinued Limited Availability (LA).....	59
Sliding Screen Replacement - Configured Part in OMS.....	62
Sliding Screen Parts.....	63
Sliding Screen Replacement - Disc Limited Availability (LA).....	66
Sliding Screen Parts - Discontinued No Availability (NA).....	68

Produced	Unit Type	Features and Changes
1999	Swinging Door	06/1999: Unit features 3/4" insulating Low E II tempered glass with Argon, mortise style multi-point locking system, keyed brass handle, 4 9/16" and 6 9/16" depths; adjustable hinges, solid wood interior, oak sill liner and an optional top hung or swinging color matched screen (depending on configuration). The Swinging Door is available in one panel (2668, 3068) stationary or operator and two panel (5068, 6068) center hinged configurations. Factory mulling is available (depending on configuration). Pultruded fiberglass (Ultrex) one piece frame in white or pebble gray. 09/1999: Temporarily substituted current Venise style handle with Capri style handle from 9/21/99 to 11/8/99.
2000	Swinging Door	05/2000: Redesigned sill strike to incorporate a weep system and eliminate the weep in the center of the sill. 12/2000: 5 5/16" jamb extension no longer available.
2001	Swinging Door	03/2001: Added white interior finish. 04/2001: "Through the jamb" installation introduced. Pre-drilled holes located at top and bottom of jambs. Included is a kit with necessary screws and color matched plugs.
2002	Swinging Door	02/04/2002: Stone White replacing Arctic White as a standard color effective Feb. 4. Arctic White replacement parts available through the warranty period.
2003	Swinging Door	05/06/2003: Pebble and Stone White screens now both use new screen profile. A213 roller bar and A214 head jamb screen track now obsolete. Replaced with integral roller bar on panel and A2137 head jamb screen track. See Screen and Screen Parts section for more details.
2004	Inswing French Door	03/01/2004: Name change from Swinging Door to Inswing French Door consistent with Marvin door nomenclature. Standard 6-0 door width changed from 73 to 72 opening. Added two panel XX configuration and pebble exterior/white interior GBGs.
2005	Inswing French Door	01/17/2005: Added Oil Rubbed Bronze and Satin Nickel as standard hardware options. Added Gray, Brown, and White hinges as field applied options.
2006	Inswing French Door	09/2006: SDL offered on all Elevate series windows and doors. 7/8" wide bars with Ultrex exterior and wood interior. See Product Bulletin 66 for more details.
2007	Inswing French Door	03/2007: Bronze exteriors introduced. New handle set, using the new Outswing French door handle set. Changed multi-point lock to use new Outswing French Door lock. 11/2007: Evergreen exteriors introduced.
2008	Inswing French Door	03/17/2008: Cashmere exteriors introduced. 07/2008: Cottage SDL lite cut made available for Wood-Ultrex. Refer to product bulletin #99.
2009	Inswing French Door	05/2009: LoE3 366™ glass option introduced. Call number sizes 2-8 and 5-4 added. 08/2009: Design changes include double bulb weather strip at sill (also at astragal on XX configurations), a rigid sill ramp and a header strike plate.
2010	Inswing French Door	01/2010: Introduced the new grille tack and installation tool and added to the accessory chapter. Header strike screw was changed from #6 to #8. 02/2010: Header strike screw was changed from #6 to #8. Introduced new non handed hinge design.
2012	Inswing French Door	07/30/2012: Stationary Panel Setting Block replaced with V2055 Standing Block. 08/27/2012: Introduced Ebony exterior and exterior casing options.
2014	Inswing French Door	04/28/2014: Interior and Exterior Split Finish option became available so customers could choose different colors between exterior and interior handles. All current handle styles were given the name Cambridge. Handles are no longer available in sets. Introduced Special Size Door options. An addition of a CN 7-0 height option, available in 1/64" increments. 10/27/2014: Added Northfield hardware handle sets.
2016	Inswing French Door	08/29/2016: Introduced G3 Inswing French Door, HP, and IZ3 products; Discontinued Inswing French Door G2 production; Cambridge exterior escutcheon width reduced; New hinge release; added Oil Rubbed Bronze hinge option, Bronze Sill / Dark Weatherstrip package release; IZ3 SDLs option release. Arctic White frame parts no longer available for field service. Discontinued Swinging Door frame components (pre-2004).
2017	Inswing French Door	10/30/2017: Added availability to add locking handle to secondary panel. 12/18/2017: Added availability of customer specified divided lite cuts for SDL with and with out spacer bar and GBG. To include simulated check rail and allow any color GBG to the exterior only of standard and special sized units.

Produced	Unit Type	Features and Changes
2018	Inswing French Door	<p>08/27/2018: Updated the Screen Roller Guide Assembly to Screen Roller Guide, V2932. The new screen Roller Guide can be used on all doors manufactured on or after 8/29/2016.</p> <p>10/22/2018: Updated header and sill strike plates on XX units to a one-piece strike plate. The new strike can be used on all doors manufactured on or after 8/29/2016.</p> <p>10/29/2018: Introduced Designer Black and Clear interior finishes and Matte Black (MBK) hardware option. Replaced Oak Sill Liner W12710 with V2736, HP/IZ3 W12496 with V2960 and W2528 with V2935. All products will use the new Cellular PVC sill liner in place of the Oak. Low E3 ERS glass type was added.</p> <p>12/17/2018: Introduced textured glass types: Obscure, Reed, Narrow Reed, Rain, Glue Chip and Frost and also colored glass types: Clear, Bronze, Gray and Green.</p>
2019	Inswing French Door	12/16/2019: Discontinued the sale of Wood Removable Grilles.
2020	Inswing French Door	02/14/2020: The sliding screen handle position was changed to a height dimension of 38" from the bottom of the screen to the center of the handle.
2021	Inswing French Door	10/25/2021: Standard screen mesh changed to Marvin Bright View™. See product bulletin 793 for more information.
2022	Inswing French Door	10/31/2022: Evergreen exterior discontinued. See Product Bulletin 863 for more information.
2023	Inswing French Door	02/27/2023: Gunmetal introduced. See Product Bulletin 863 for more information.

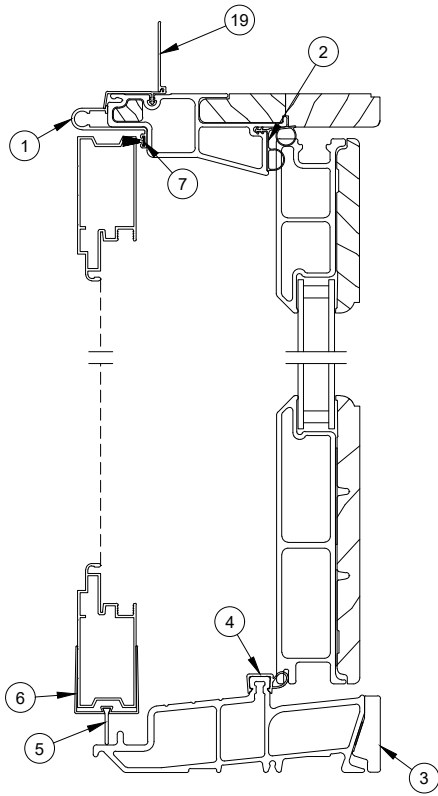

Head Jamb and Sill Detail

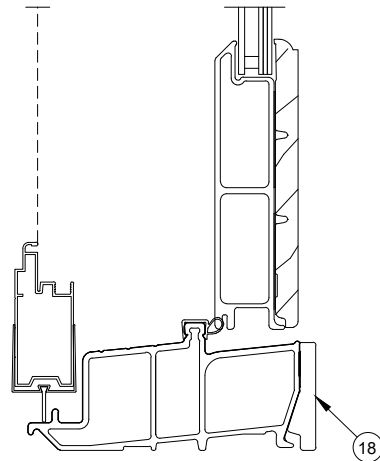

Sill Detail, HP/IZ3

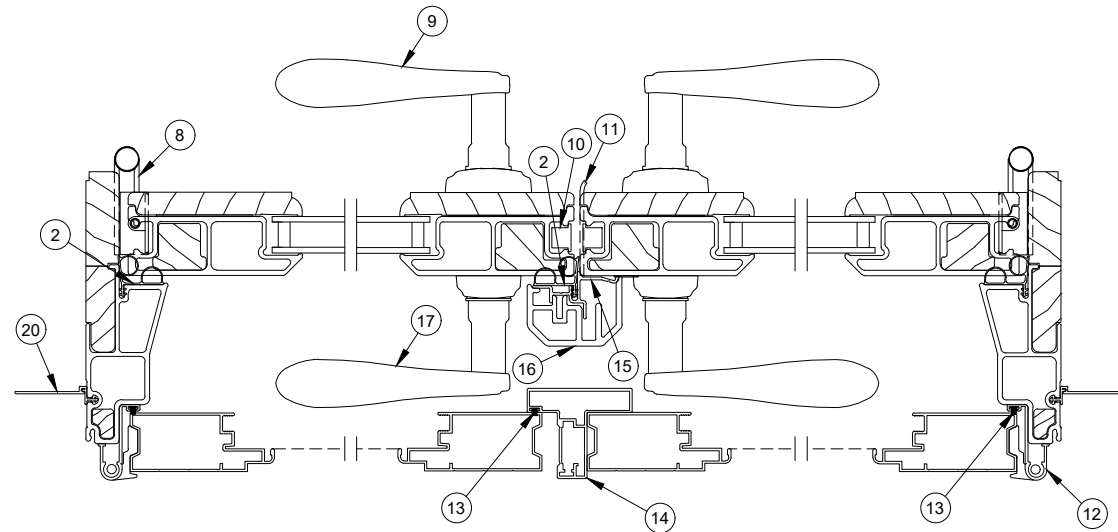

Jamb Detail

1. Z-bar Channel, A1308
2. Head Jamb/Jamb/Astragal Weather Strip, V2350
3. Sill Liner, V2736
4. Sill Weather Strip, V2026
5. Vinyl Sweep
6. Bottom Expander
7. Pile Weather Strip (Swinging)
8. Adjustable Hinge
9. Interior Handle
10. Multi-point Lock
11. Secondary Strike Plate
12. Z-bar Screen Hinge, A1308
13. Pile Weather Strip (Swinging)
14. Swinging Screen Astragal
15. Astragal Cap, A2815
16. Astragal Base - Exterior, A2571
17. Exterior Handle
18. Sill Liner, HP/IZ3, V2960
19. Head Jamb Nailing Fin/Drip Cap, V119
20. Jamb Nailing Fin, V104

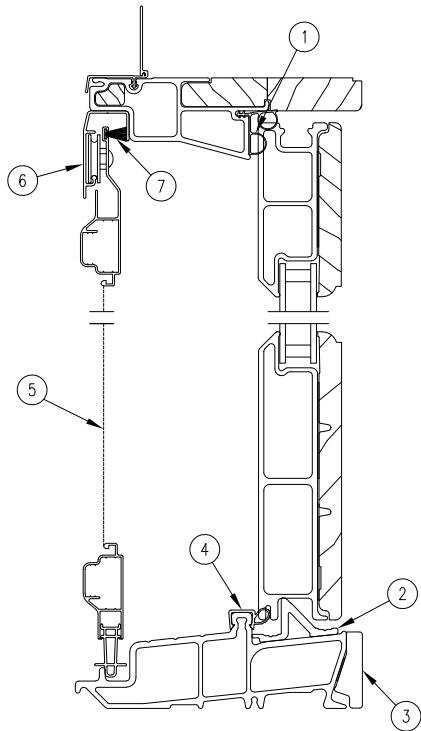

Head Jamb and Sill Detail

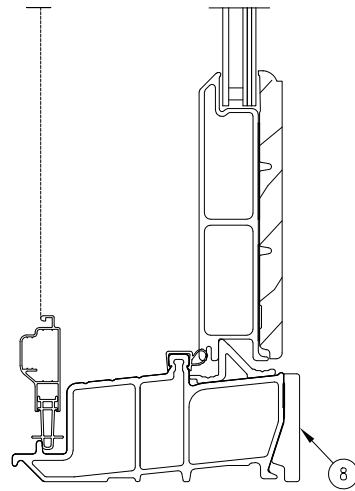

Sill Detail HP/IZ3

1. Head Jamb Weather Strip, V2350
2. Sill Retainer, Stationary, V2460
3. Sill Liner, V2736
4. Sill Weather Strip, V2026
5. Screen Panel
6. Screen Top Hanger
7. Pile Weather Strip (Sliding)
8. Sill Liner, HP/IZ3, V2960
9. Jamb Weather Strip, V2350
10. Multi-point Lock
11. Jamb Strike Plate
12. Interior Handle
13. Adjustable Hinge
14. Stationary Panel Retainer
15. Astragal/Mull Post Base, A2571
16. Astragal/Mull Post Weather Strip, V2350
17. Mull Post, A2567
18. Exterior Handle

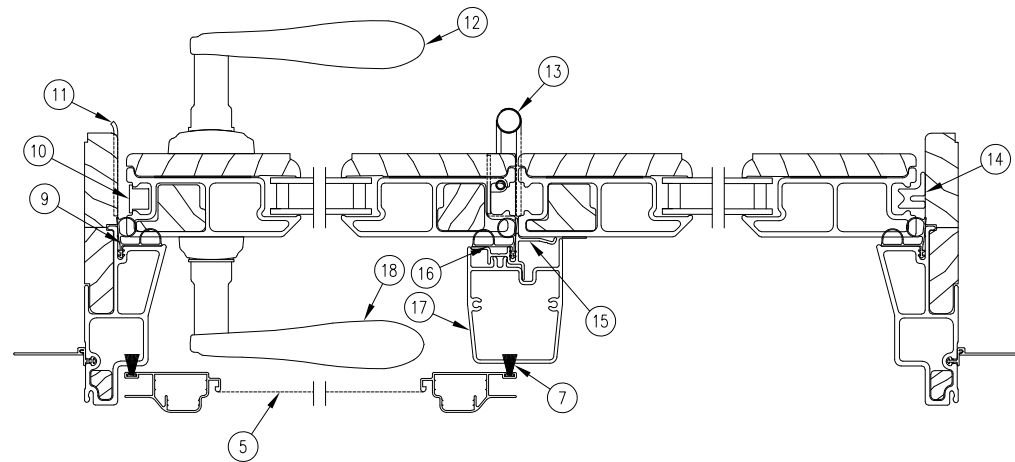

Jamb Detail

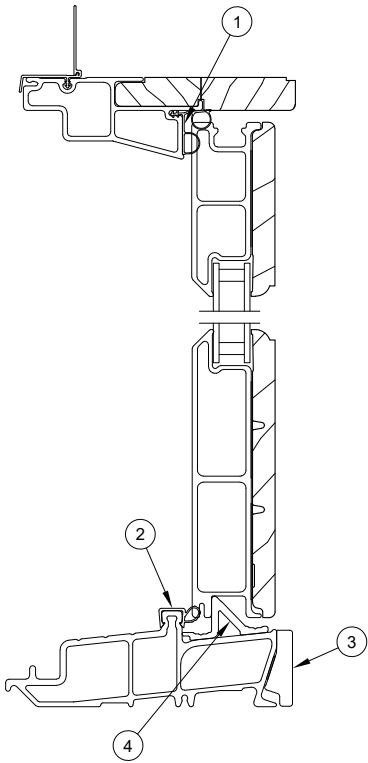

Head Jamb and Sill Detail

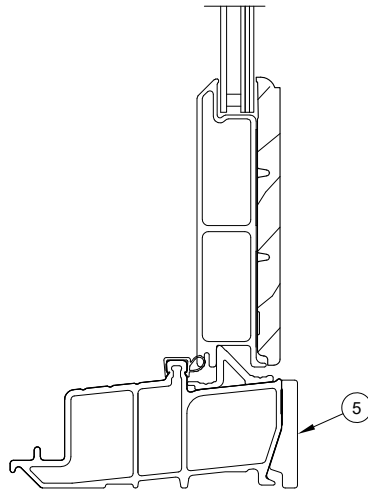

Sill Detail HP/IZ3

1. Head Jamb Weather Strip, V2350
2. Sill Weather Strip, V2026
3. Sill Liner, V2736
4. Sill Retainer, Stationary, V2460
5. Sill Liner, HP/IZ3, V2960
6. Jamb Weather Strip, V2350
7. Jamb Panel Clip

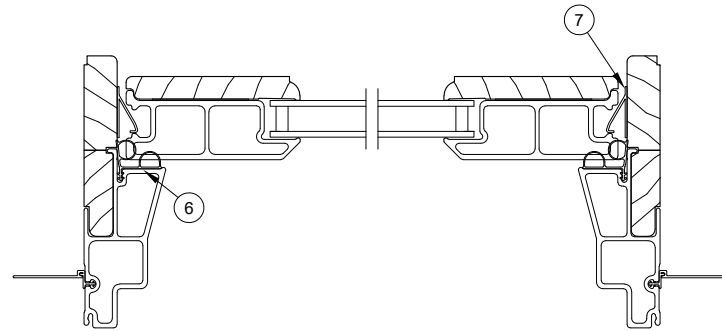

Jamb Detail

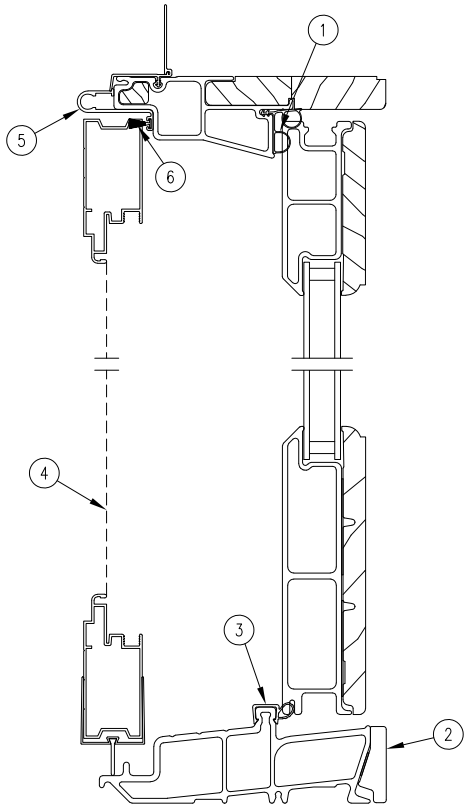

Head Jamb and Sill Detail

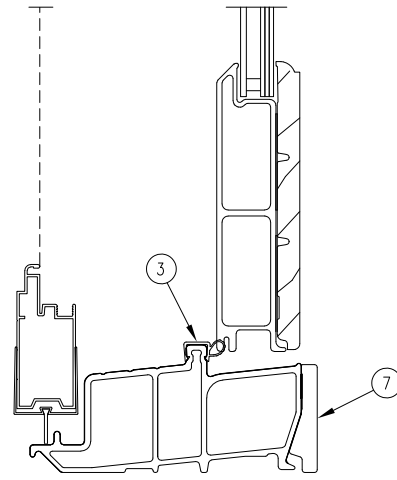

Sill Detail HP/IZ3

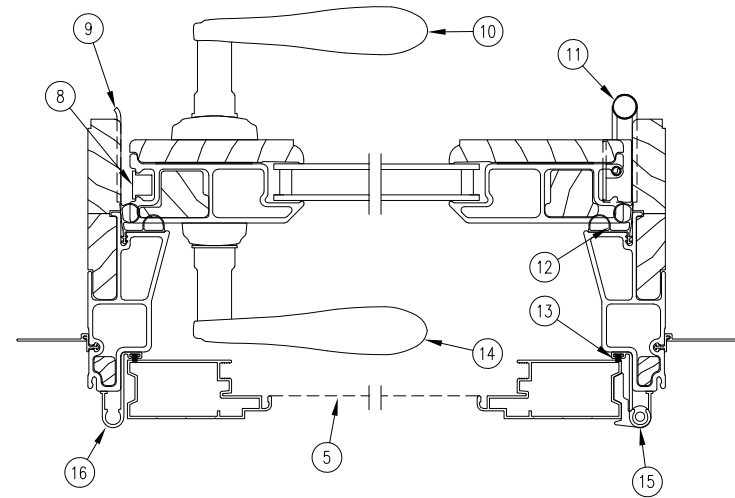

Jamb Detail

- | | |
|-----------------------------------|-----------------------------------|
| 1. Head Jamb Weather Strip, V2350 | 9. Jamb Strike Plate |
| 2. Sill Liner, V2736 | 10. Interior Handle |
| 3. Sill Weather Strip, V2026 | 11. Adjustable Hinge |
| 4. Screen Panel | 12. Jamb Weather Strip, V2350 |
| 5. Z-Bar Channel | 13. Pile Weather Strip (Swinging) |
| 6. Pile Weather Strip (Swinging) | 14. Exterior Handle |
| 7. Sill Liner, HP/IZ3, V2960 | 15. Screen Hinge Z-Bar |
| 8. Multi-Point lock | 16. Z-Bar Channel |

Primary Installation Kit (all units)

Includes:

- 1 - General door installation instructions
- 1 - Elevate Inswing G3 Installation
- 1 - Sliding screen dust block - 10500161 (a)
- 1 - #10 x 2 3/4" flathead masonry screws - 11800869 (b)
- 10 - #8 x 3" Phillips pan head screws, stainless steel - 11800829 (c)

Usage dates:

08/29/2016 to present

PN
11898920

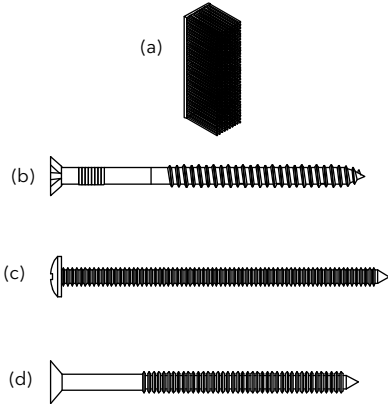

Operator Installation Kit, X, XO/OX,XX

Includes:

- 5 - #8 x 2 1/2" Phillips flat head screws, stainless steel - 11800648 (d)
- 1 - #8 x 2 1/2" Phillips flat head screws, brass - 11805165 (d)

NOTE: HP/IZ3 units - order qty 2

Usage dates:

08/29/2016 to present

PN
11898925

Hinge Installation Screws Package

Includes:

- 4 - #8 x 2 1/2" Phillips flat head screws (d)

Usage dates:

08/29/2016 to present

Color	PN
Gold	11808216
Silver	11808217
Almond Frost	11882369
Stone White	11882361
Dark Brown	11882362
Stainless Steel	11882365
Brass	11882363

X - order 1 package
 XX or X-HP/Impact - order 2 packages
 XX-HP/Impact - order 3 packages

Structural Bracket Installation Kit

Includes:

11 - Structural brackets
 33 - #8 x 5/8" Type AB - 17 flat head screws (11800758)

Usage dates:

08/29/2016 to present

PN
11898945

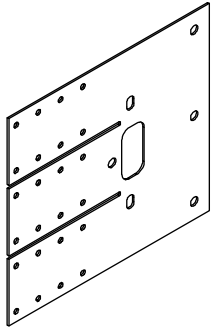

IZ3 Installation Clip, 4 9/16"

Includes:

11 - Impact clips
 33 - #8 x 5/8" Type AB - 17 flat head screws (11800758)

Usage dates:

08/29/2016 to present

PN
11898950

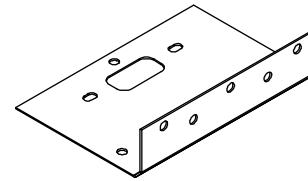

IZ3 Installation Clip, 6 9/16"

Includes:

11 - Impact clips
 33 - #8 x 5/8" Type AB - 17 flat head screws (11800758)

Usage dates:

08/29/2016 to present

PN
11898955

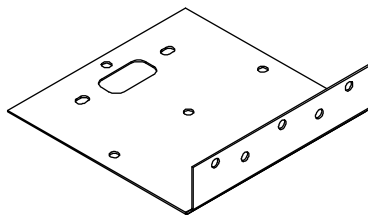

Jamb Filler Hole Plug

Usage dates:

08/29/2016 to present

Qty	Color	PN
Pack of 10	Stone White	11892507
	Pebble	11892506
	Bronze	11892508
	Cashmere	11892510
	Black	11892511
	Gunmetal	11882507
	*Evergreen	11892509

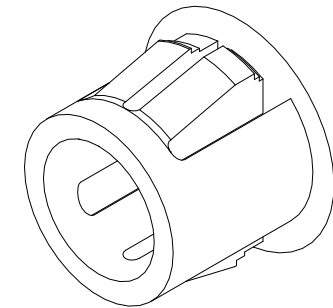

NOTE: *DISC (LA) used prior to 10/29/2022

Cambridge Primary Handle Set, Exterior

Includes:

- 1 – Exterior handle
- 1 – Exterior escutcheon
- 1 – Hardware gasket
- 1 – Z Clip
- 1 – Z Clip screw
- 1 – Keyed cylinder
- 2 – Keys

Usage dates:

08/29/2016 to present

NOTE: Escutcheon width 1.350"

Color	XX-L, X-L, OX	XX-R, X-R, XO
Almond Frost	11868026	11868021
Stone White	11868031	11868019
Brass PVD	11868028	11868023
Satin Nickel PVD	11868029	11868024
Oil Rubbed Bronze PVD	11868030	11868025
Matte Black	11868069	11868068

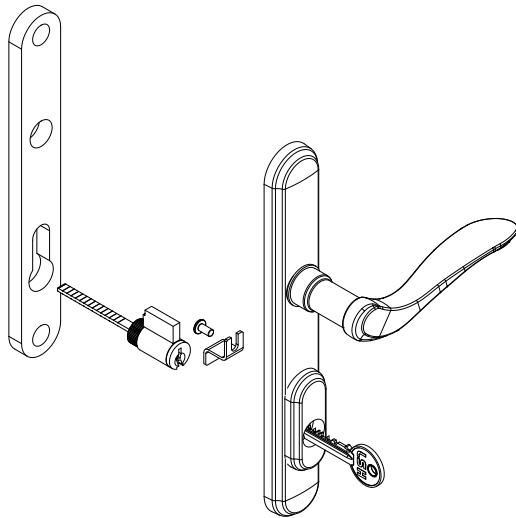

XX-R, X-R shown

Cambridge Primary Handle Set, Interior

Includes:

- 1 – Interior handle
- 1 – Interior escutcheon
- 1 – Spring cassette
- 1 – Spindle
- 1 – Thumb turn
- 2 – M5 x 58 machine screws

Color	XX-L, X-L, OX	XX-R, X-R, XO
Almond Frost	11869106	11869101
Stone White	11869210	11869209
Brass PVD	11869108	11869103
Satin Nickel PVD	11869109	11869104
Oil Rubbed Bronze PVD	11869110	11869105
Matte Black	11869149	11869169

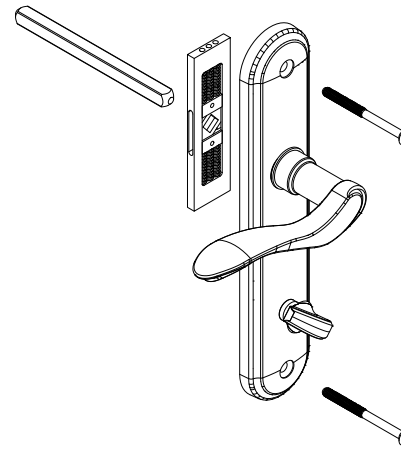

XX-R, X-R shown

Cambridge Secondary Handle Set, Exterior

Includes:

- 1 – Exterior handle
- 1 – Exterior escutcheon
- 1 – Hardware gasket

Usage dates:

08/29/2016 to present

NOTE: Escutcheon width 1.350”

Color	XX-R	XX-L
Almond Frost	11868046	11868041
Stone White	11868037	11868032
Brass PVD	11868048	11868043
Satin Nickel PVD	11868049	11868044
Oil Rubbed Bronze PVD	11868050	11868045
Matte Black	11868071	11868070

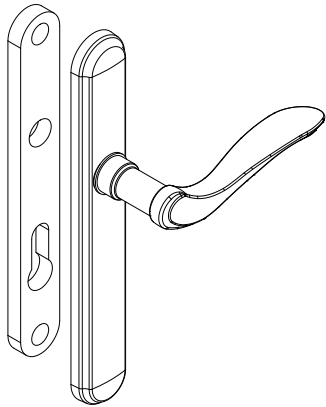

XX-L shown

Cambridge Secondary Handle Set, Interior

Includes:

- 1 – Interior handle
- 1 – Interior escutcheon
- 1 – Spring cassette
- 1 – Spindle
- 2 – M5 x 58 machine screws

Color	XX-R	XX-L
Almond Frost	11869126	11869121
Stone White	11869227	11869222
Brass PVD	11869128	11869123
Satin Nickel PVD	11869129	11869124
Oil Rubbed Bronze PVD	11869130	11869125
Matte Black	11869159	11869150

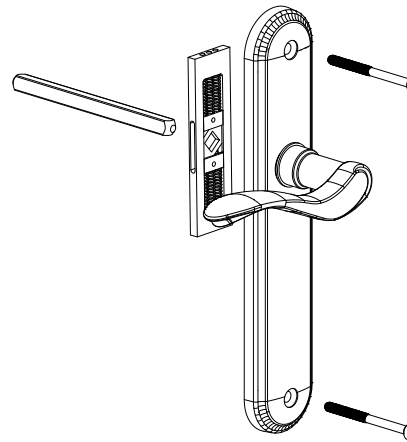

XX-L shown

Northfield Primary Handle Set, Exterior

Includes:

- 1 – Exterior handle
- 1 – Exterior escutcheon
- 1 – Hardware gasket
- 1 – Z Clip
- 1 – Z Clip screw
- 1 – Keyed cylinder
- 2 – Keys

Usage dates:

10/2014 to present

Color	PN
Almond Frost	11869161
Stone White	11869162
Brass PVD	11869163
Satin Nickel PVD	11869164
Oil Rubbed Bronze PVD	11869165
Matte Black	11869168

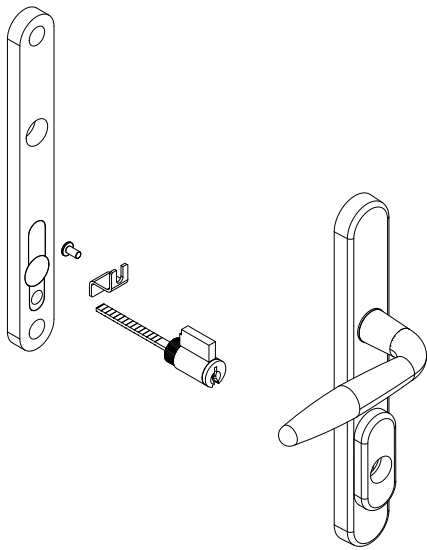

Northfield Primary Handle Set, Interior

Includes:

- 1 – Interior handle
- 1 – Interior escutcheon
- 1 – Spring cassette
- 1 – Spindle
- 1 – Thumb turn
- 2 – M5 x 58 machine screws

Usage dates:

10/2014 to present

Color	PN
Almond Frost	11869151
Stone White	11869152
Brass PVD	11869153
Satin Nickel PVD	11869154
Oil Rubbed Bronze PVD	11869155
Matte Black	11869160

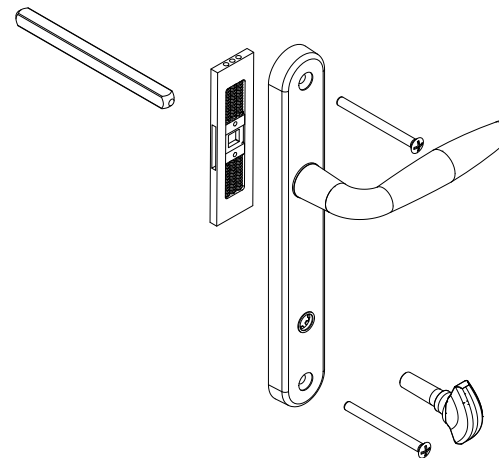

Northfield Secondary Handle Set, Exterior

Includes:

- 1 - Exterior handle
- 1 - Exterior escutcheon
- 1 - Handle gasket

Usage dates:

10/2014 to present

Color	PN
Almond Frost	11869181
Stone White	11869182
Brass PVD	11869183
Satin Nickel PVD	11869184
Oil Rubbed Bronze PVD	11869185
Matte Black	11869190

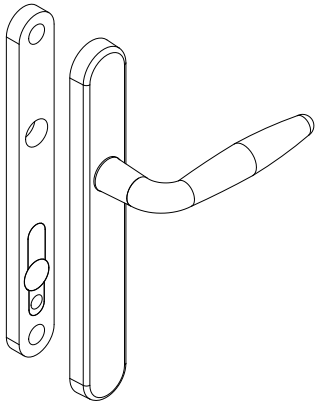

Northfield Secondary Handle Set, Interior

Includes:

- 1 - Interior handle
- 1 - Interior escutcheon
- 1 - Spring cassette
- 1 - Spindle
- 2 - M5 x 58 machine screws

Usage dates:

10/2014 to present

Color	PN
Almond Frost	11869171
Stone White	11869172
Brass PVD	11869173
Satin Nickel PVD	11869174
Oil Rubbed Bronze PVD	11869175
Matte Black	11869180

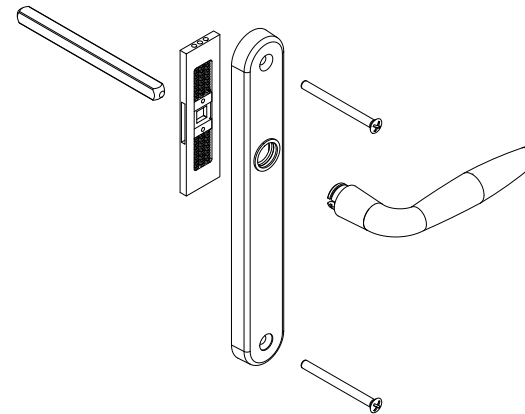

Hardware Gasket

PN
11860969

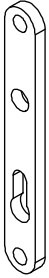

Escutcheon Plate Screws

NOTE: 1-M5 x 58 machine screw

Color	PN
Brass PVD	11805189
White	11805188
Almond Frost	11805187
Satin Nickel PVD	11805190
Oil Rubbed Bronze PVD	11805191
Matte Black	11805143

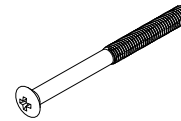

Z-Clip

Includes:

2 - Fasteners

NOTE: Used on both Cambridge and Northfield hardware

PN
11860967

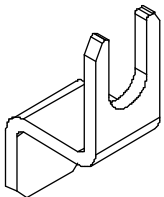

Spring Cassette

PN
11860960

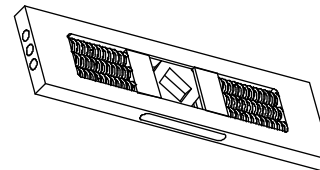

Secondary Panel Lock Handle Template

NOTE: Handle retro-fit instructions (19915821) not included.

NOTE: Not to scale.

PN
10503000



Keyed Cylinder with Keys

Includes:

2 - Keys

NOTE: Schlage cylinder

NOTE: For keyed alike cylinders, please contact your Marvin representative. Please supply the original order number if possible.

Color	PN
Brass	11860963

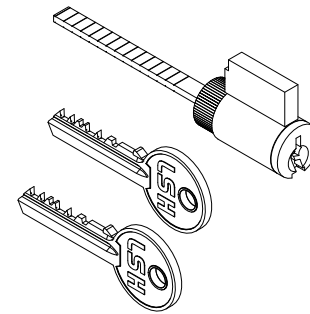

Replacement Washers

PN
11860964



Split Ring

PN
11860966

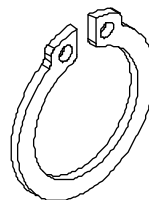

Spindle

PN
11860962

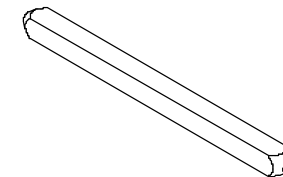

Cambridge Primary Handle Set, Exterior

Includes:

- 1 – Exterior Handle
- 1 – Exterior Escutcheon
- 1 – Hardware Gasket
- 1 – Z Clip
- 1 – Z Clip Screw
- 1 – Keyed Cylinder
- 2 – Keys

Usage dates:

03/2007 - 08/29/2016

NOTE: Escutcheon width 1.796”

Color	XX-L, X-L, OX PN	XX-R, X-R, XO PN
Almond Frost	11869116	11869111
White	11869117	11869112
Brass PVD	11869118	11869113
Satin Nickel PVD	11869119	11869114
Oil Rubbed Bronze PVD	11869156	11869115

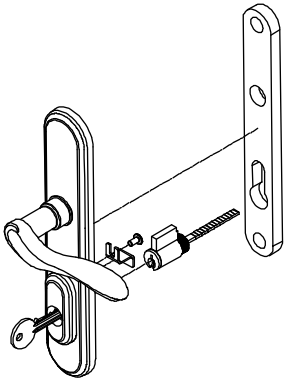

XX-R, X-R shown

Cambridge Secondary Handle Set, Exterior

Includes:

- 1 – Exterior Handle
- 1 – Exterior Escutcheon
- 1 – Hardware Gasket

Usage dates:

03/2007 - 08/29/2016

NOTE: Escutcheon width 1.796”

Color	XX-L	XX-R
Almond Frost	11869131	11869136
White	11869132	11869137
Brass PVD	11869133	11869138
Satin Nickel PVD	11869134	11869139
Oil Rubbed Bronze PVD	11869135	11869140

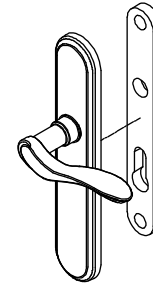

XX-R shown

Escutcheon Plate Screws

Includes:

2 - #10 x 2" pan head machine screws

Usage dates:

2004 - 03/2007

Color	PN
Brass	11801014
Stone White	11801018
Almond Frost	11801019
Satin Nickel	11801021
Oil Rubbed Bronze	11801022

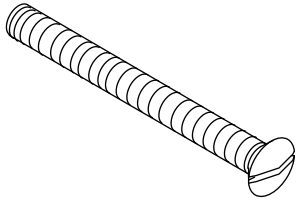

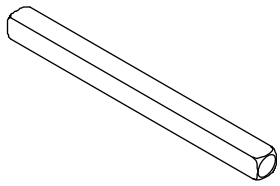

Spindle

Usage: 2004 to 03/2007

Replace with 11860962

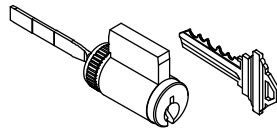

**Keyed Schlage Cylinder
with keys**

Usage: 2004 to 03/2007

NOTE: Always view units from the exterior for handing.
H=Hinge location

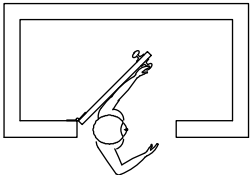

LH Inswing

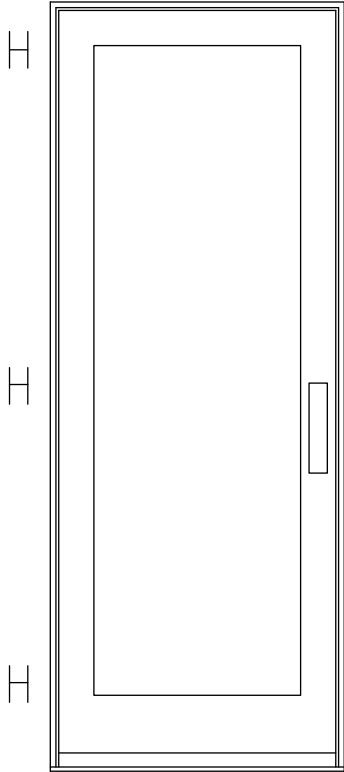

X-LH Inswing

This panel uses the left hand hinge

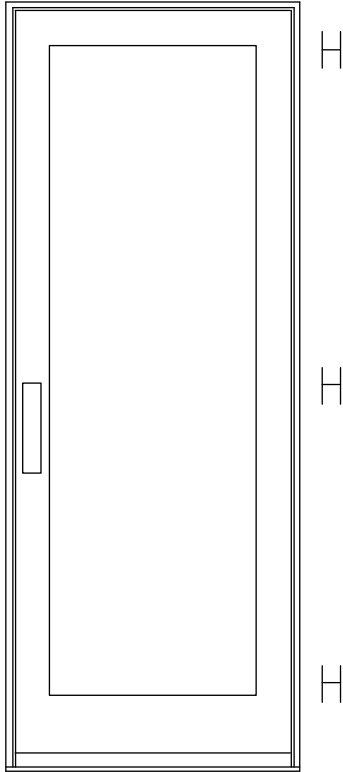

X-RH Inswing

This panel uses the right hand hinge

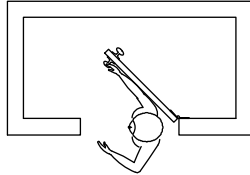

RH Inswing

Adjustable Hinge

Includes:

- 1 – Hinge gasket
- 3 – #8 x 5/8" Phillips flat head screw (into jamb)
- 8 – #8 x 1 1/2" Phillips flat head screw (into panel)
- 2 – #8 x 2 1/2" Phillips flat head screw (installation into jamb)
- 1 – Hinge retro-fit instructions

NOTE: All screws are color matched

NOTE: For units produced before 6/26/2017: 3 hinge kits for frame height <= to 82.000", 4 hinge kits for frame height > than 82.000".

Color	X-R, XX-R	X-L, XX-L
Gold	11891400	11891401
Gray	11891402	11891403
Almond Frost	11891408	11891409
Cashmere	11891420	11891421
Pebble	11891418	11891419
Dark Brown	11891404	11891405
White	11891406	11891407
Ebony	11891422	11891423
Brass PVD	11891410	11891411
Satin Nickel PVD	11891412	11891413
Oil Rubbed Bronze PVD	11891414	11891415
*Evergreen	11891416	11891417

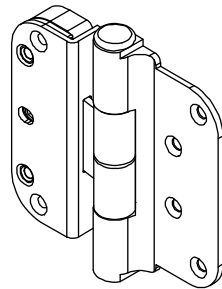

RH shown

Hinge Spacer Block

Usage dates:

03/2004 to present

Color	PN
Stone White	11860167
Pebble	11860166
Bronze	11860165
Cashmere	11860183
Ebony	11860184
Gunmetal	11880167
*Evergreen	11860179

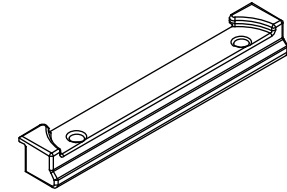

Hinge Adjustment Tool

Usage dates:

1999 - 08/29/2016

PN
10502561

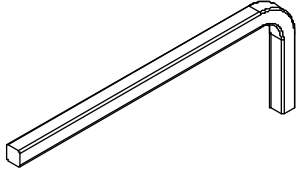

NOTE: Replace with adjustable hinge, L/R. Please specify total hinge quantity on unit when placing Field Service order

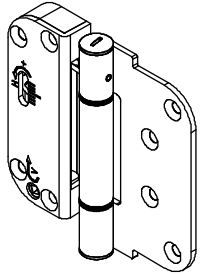

Non Handed Hinge

Usage: 02/22/2010 to
08/29/2016

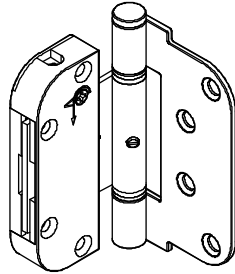

Set Hinge

Usage: 03/01/2004 to
02/21/2010

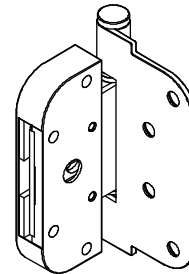

Guide Hinge

Usage: 03/01/2004 to
02/21/2010

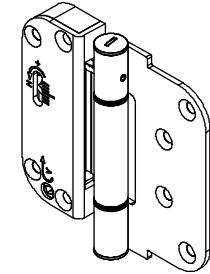

**Non Handed Hinge
Update Kit**

Usage: Pre 03/2004

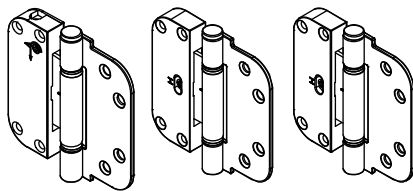

Hinge Kit

Usage: 1999 to 03/2004

Active Multi-Point

Includes:

1 - Lock assembly with faceplate, deadbolt, latch and shoot bolts
 11 (13 on 8/0) - #8 x 1 1/2" Phillips flat head stainless steel screws

Usage dates:

03/2007 to present

CN	Color	PN
6-5	Stainless Steel	11896701
6-8		11896702
7-0		11895700
8-0		11896703

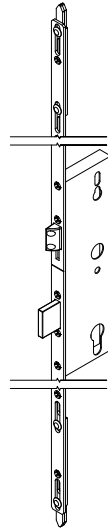

Special Size Active Multi-Point

Includes:

1 - Lock assembly with faceplate, deadbolt, latch and lower shoot bolts
 1 - Top shoot bolt extension
 12 - #8 x 1 1/2" Phillips flat head stainless steel screws

Usage dates:

03/2007 to present

NOTE: ETO order required for special size doors. Rough Opening, Jamb Depth, and Door manufacture date required to provide correct component.

Color	PN
Stainless Steel	11895701

Inactive Multi-Point

Includes:

1 - Lock assembly with faceplate and shoot bolts
 11 (13 on 8/0) - #8 x 1 1/2" Phillips flat head stainless steel screws

Usage dates:

03/2007 to present

CN	Color	PN
6-5	Stainless Steel	11896704
6-8		11896705
7-0		11894700
8-0		11896706

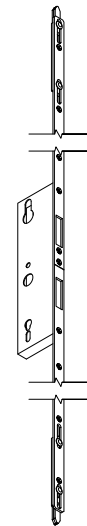

Special Size Inactive Multi-Point

Includes:

1 - Lock assembly with faceplate and lower shoot bolts
 1 - Top shoot bolt extension
 12 - #8 x 1 1/2" Phillips flat head stainless steel screws

Usage dates:

03/2007 to present

NOTE: ETO order required for special size doors. Rough Opening, Jamb Depth, and Door manufacture date required to provide correct component.

Color	PN
Stainless Steel	11894701

Active Multi-Point, HP/IZ3

Includes:

- 1 - Lock assembly with faceplate, deadbolt, latch and shoot bolts
- 11 (13 on 8/0) - #8 x 1 1/2" Phillips flat head stainless steel screws
- 2 - #8-15 x 2 1/2" Type AT/F, 2/3 thread, stainless steel screws

Usage dates:

03/2007 to present

CN	Color	PN
6-5	Stainless Steel	11891300
6-8		11891301
7-0		11891302
8-0		11891303



Special Size Active Multi-Point, HP/IZ3

Includes:

- 1 - Lock assembly with faceplate, deadbolt, latch and lower shoot bolts
- 1 - Top shoot bolt extension
- 12 - #8 x 1 1/2" Phillips flat head stainless steel screws
- 2 - #8-15 x 2 1/2" Type AT/F, 2/3 thread, stainless steel screws

Usage dates:

03/2007 to present

NOTE: ETO order required for special size doors. Rough opening, jamb depth, and door manufacture date required to provide correct component.

Color	PN
Stainless Steel	11861999

Inactive Multi-Point, HP/IZ3

Includes:

- 1 - Lock assembly with faceplate and shoot bolts
- 11 (13 on 8/0) - #8 x 1 1/2" Phillips flat head stainless steel screws

Usage dates:

03/2007 to present

CN	Color	PN
6-5	Stainless Steel	11891304
6-8		11891305
7-0		11891306
8-0		11891307

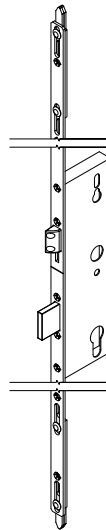

Special Size Inactive Multi-Point, HP/IZ3

Includes:

- 1 - Lock assembly with faceplate and lower shoot bolts
- 1 - Top shoot bolt extension
- 12 - #8 x 1 1/2" Phillips flat head stainless steel screws

Usage dates:

03/2007 to present

NOTE: ETO order required for special size doors. Rough opening, jamb depth, and door manufacture date required to provide correct component.

Color	PN
Stainless Steel	11891899

Multi-Point Lockbox, Active

PN
11896707

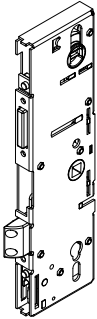

Multi-Point Lockbox, Passive

PN
11896708

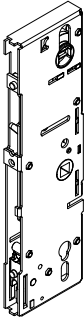

Strike Plate, Locking Jamb

Usage dates:

08/29/2016 to present

Configuration	Color	PN
XO or X-R	Stainless Steel	11860337
	Brass	11860335
OX or X-L	Stainless Steel	11860338
	Brass	11860336



X-L shown

Suggested Fasteners	Color	PN
2 - #8 x 5/8" Phillips flat head Stainless Steel screws	Stainless Steel	11805180
	Brass	11800580
1 - #8 x 2 1/2" Phillips flat head Stainless Steel screws	Stainless Steel	11800648
	Brass	11805165

Strike Plate, Secondary Lock

Usage dates:

03/26/2017 to present

Configuration	Color	PN
XX-R	Stainless Steel	11896560
	Brass	11860187
XX-L	Stainless Steel	11896559
	Brass	11860186

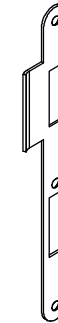

XX-R shown

Suggested Fasteners	Color	PN
1 - 4mm x 16mm Torx flat head machine screw	Stainless Steel	11805183
1 - 4mm x 8mm Torx flat head machine screw	Stainless Steel	11805181
1 - 4mm x 35mm Torx flat head machine screw	Stainless Steel	11805184

Rhino Hook Strike Plate, HP/IZ3

Usage dates:

08/29/2016 to present

Color	PN
Stainless Steel	11862546

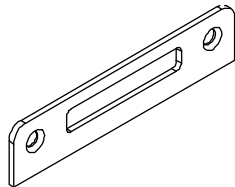

Suggested Fasteners	PN
2 - #8 x 2 1/2" Phillips flat head stainless steel screws	11800648

Installation Bracket Sill, HP/IZ3

PN
11860102

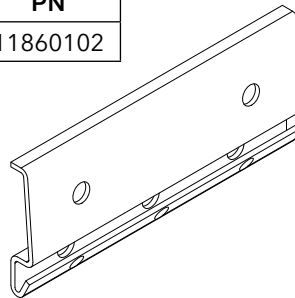

Stationary Lock Bar

Usage dates:

08/29/2016 to present

Color	PN
Stainless Steel	11860229

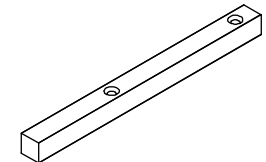

Suggested Fasteners	PN
2 - #8 x 2 1/2" Phillips flat head Stainless Steel screws	11800648

Head Jamb Strike Plate - X, OX,XO

Usage dates:

08/29/2016 to present

Configuration	Color	PN
XO or X-R	Stainless Steel	11862580
OX or X-L		11862581

Suggested Fasteners	PN
2 - #8 x 5/8" Phillips flat head Stainless Steel screws	11805180
2 - #8 x 2 1/2" Phillips flat head Stainless Steel screws	11800648

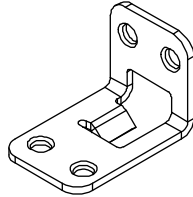

X-R shown

Sill Strike Plate - X, OX, XO

Usage dates:

08/29/2016 to present

Configuration	Color	PN
XO or X-R	Stainless Steel	11862571
OX or X-L		11862572

Suggested Fasteners	PN
2 - #8 x 5/8" Phillips flat head Stainless Steel screws	11805180

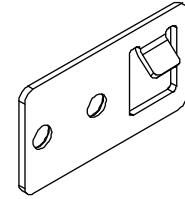

X-R shown

Head Jamb/Sill Stationary Lock Bar Strike Plate - XO, OX

Usage dates:

08/29/2016 to present

PN
11862585

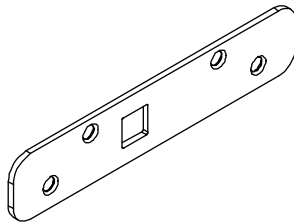

	Suggested Fasteners	PN
For Sill	4 - #8 x 5/8" Phillips flat head Stainless Steel screws	11805180
For Head Jamb	2 - #8 x 5/8" Phillips flat head Stainless Steel screws	11805180
	2 - #8 x 2 1/2" Phillips flat head Stainless Steel screws	11800648

Strike Plate - Locking Jamb

Usage dates:

06/1999 - 08/29/2016

Color	X-R, XO	X-L, OX
Stainless Steel	11860161	11860162
Brass	11860163	11860164



XO or X-L
shown

Strike Plate - Secondary Lock

Usage dates:

1999 - 03/26/2007

Color	XX-R	XX-L
Stainless Steel	11860188	11860189
Brass	11860186	11860187

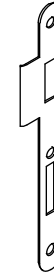

XX-R
shown

Head Jamb/Sill Strike Plate - XX

Usage dates:

08/29/2016 - 10/21/2018

Color	PN
Stainless Steel	11862589

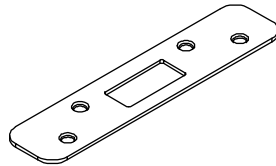

	Suggested Fasteners	Color	PN
Head Jamb	2 - #8 x 5/8" Phillips flat head stainless steel screws	Stainless Steel	11805180
	2 - #8 x 2 1/2" Phillips flat head stainless steel screws	Stainless Steel	11800648
Sill	4 - #8 x 5/8" Phillips flat head stainless steel screws	Stainless Steel	11805180

Head Jamb/Sill Strike Ramp - XX

Usage dates:

08/29/2016 - 10/21/2018

Strike plate only for field application

Color	PN
Stainless Steel	11862584

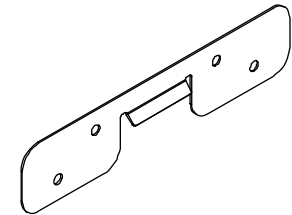

	Suggested Fasteners	Color	PN
Head Jamb	2 - #8 x 5/8" Phillips flat head stainless steel screws	Stainless Steel	11805180
	2 - #8 x 2 1/2" Phillips flat head stainless steel screws	Stainless Steel	11800648
Sill	4 - #8 x 5/8" Phillips flat head stainless steel screws	Stainless Steel	11805180

Head Jamb Strike Plate- X, OX, XO

Usage dates:

06/1999 - 08/29/2016

Color	X-R, XO	X-L, OX
Stainless Steel	11897003	11897001

Suggested Fasteners	PN
2 - #8 x 5/8" Phillips flat head stainless steel screws	11805180

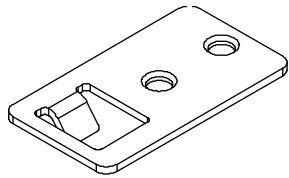

XO or X-L shown

Head Jamb Strike Plate - XX

Usage dates:

06/1999 - 08/29/2016

Color	PN
Stainless Steel	11897005

Suggested Fasteners	PN
2 - #8 x 5/8" Phillips flat head stainless steel screws	11805180

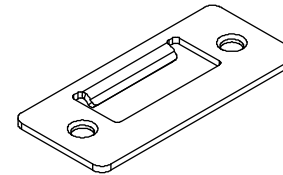

Head Jamb Strike Plate - OX, XO

Usage dates:

1999 - 08/31/2009

Color	PN
Beige	02100955

Suggested Fasteners	PN
2 - #8 x 5/8" Phillips flat head beige screws	11800476

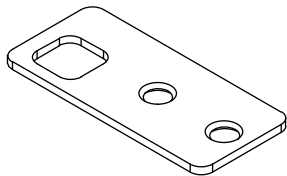

Head Jamb Strike Plate - XX

Usage dates:

1999 - 08/31/2009

Color	PN
Stainless Steel	11862546

Suggested Fasteners	PN
2 - #8 x 5/8" Phillips flat head beige screws	11800476

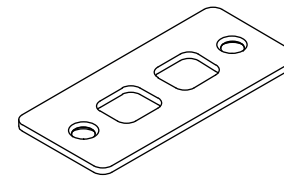

Sill Strike Plate - XX

Usage dates:

06/1999 - 08/29/2016

PN
02100954

Suggested Fasteners	PN
2 - #6 x 1 1/4" Phillips flat head beige screws	11806003

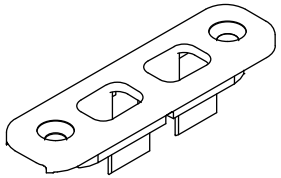

Sill Strike Insert - XX

Usage dates:

06/1999 - 08/29/2016

PN
11860194

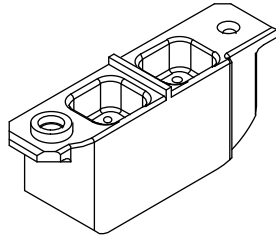

Head Jamb Strike Insert - XX

Usage dates:

06/1999 - 08/29/2016

PN
11860195

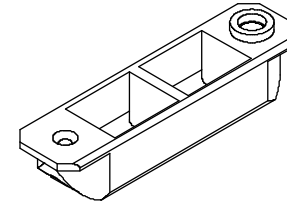

NOTE: Replace with current part for active multi-point. Refer to instruction 19915731 for retrofit information.

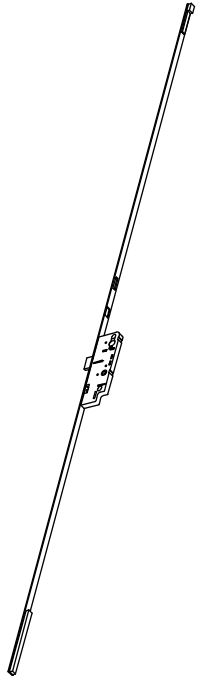

Primary Multi-Point Lock Assembly

Usage: March 2004 -
March 2007

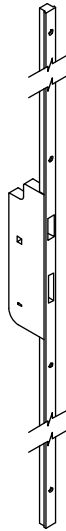

Secondary Multi-Point Lock Assembly

Usage: March 2004 -
March 2007

Stationary Panel Clip

Usage dates:

1999 to present

Color	PN
Black	11892602

Suggested Fasteners	PN
2 - #8 x 5/8" Phillips pan head screws	11800821

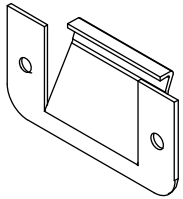

Sill Drain Weep

Usage dates:

08/29/2016 to present

Color	PN
Black	15631215

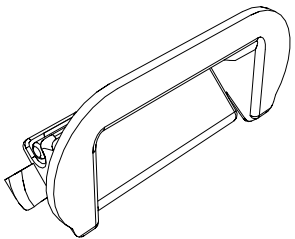

2022-09-23

Air Dam, XX

Usage dates:

08/29/2016 to present

Color	PN
Stainless Steel	11892603

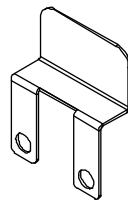

Elevate Inswing French Door

Through Jamb Plug

Color	PN
Beige	11882968
Black	11882168
Stone White	11882868

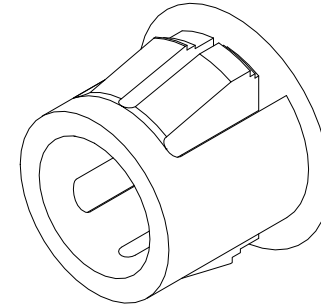

Panel Support, HP/IZ3

Usage dates:

08/29/2016 to present

Color	PN
Stainless Steel	11862633

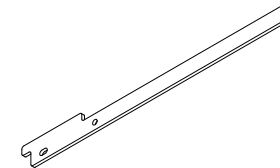

Stationary Panel Clip

Includes:

2 - Rivets

Usage dates:

06/1999 - 08/29/2016

Color	PN
Black	11860135

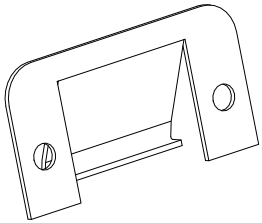

Door Stop

Usage dates:

06/1999 - 08/29/2016

PN
11860182

Suggested Fasteners	PN
2 - #8 x 1" Phillips pan head screws	11805185

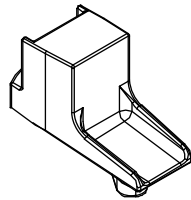

Stationary Panel Head Jamb Bracket

Usage dates:

06/1999 - 08/29/2016

PN
11860152

Suggested Fasteners	PN
1 - #8 x 1" Phillips pan head stainless steel screw	11805185
1 - #8 x 3" Phillips pan head pearl white screw	11800829
1 - Rivet	11800113

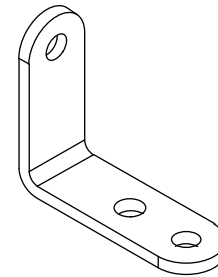

#8 x 5/8" Phillips Flat Head Screw

Usage:

Hinge Kits
Strike Plate - Jamb/Head Jamb
Z-Bar mounting screw

Color	Pkg of 25 PN	PN EA
Stone White	11882723	11805155
Dark Brown	11882724	11805156
Brass	11882725	11805153
Stainless Steel	11882726	11805180
Gold	11882720	11800495
Silver	11882721	11800491
Almond Frost	11882722	11806147

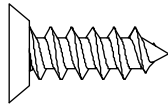

#8 x 1 1/2" Phillips Flat Head Screw

Usage:

Hinge Kits

Color	Pkg of 25 PN	PN EA
Stone White	11882713	11805169
Dark Brown	11882714	11805170
Brass	11882715	11805171
Stainless Steel	11882716	11800850
Gold	11882710	11800496
Silver	11882711	11800494
Almond Frost	11882712	11806148

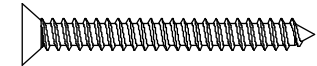

#8 x 2 1/2" Flat Head Screw

Usage:

Hinge Kits
Strike Plate - Jamb/Head Jamb

Color	Pkg of 25 PN	PN EA
Stone White	11882703	11805163
Dark Brown	11882704	11805164
Brass	11882705	11805165
Stainless Steel	11882706	11800648
Gold	11882700	11808211
Silver	11882701	11808213
Almond Frost	11882702	11806149

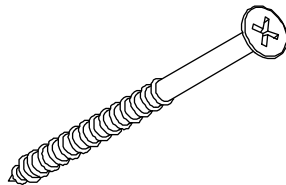

#8 x 1/2" Self-Tapping Flat Head Screw

Usage:

Head jamb screen track

Color	PN EA
Stainless Steel	11800502

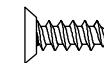

#8 x 5/8" " Pan Head Screw, A/Tek 2

Usage:

Astragal and Mull Post Cap

Color	PN EA
Stainless Steel	11800498

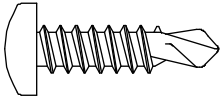

#8 x 1" Pan Head Screw

Usage:

Stationary panel header bracket

Color	PN EA
Stainless Steel	11805185

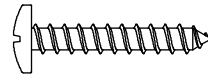

#8 x 5/8" Pan Head Screw

Usage:

Stationary Clip

Color	PN EA
Zinc Yellow	11800821

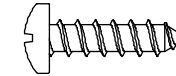

4mm x 8mm TORX Flat Head Machine Screw

Usage:

Multi-point lock

Color	PN EA
Stainless Steel	11805181

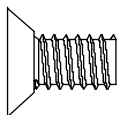

4mm x 16mm TORX Flat Head Machine Screw

Usage:

Multi-point lock

Color	PN EA
Stainless Steel	11805183

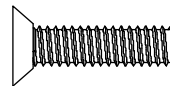

4mm x 35mm TORX Flat Head Machine Screw

Usage:

Multi-point lock

Color	PN EA
Stainless Steel	11805184

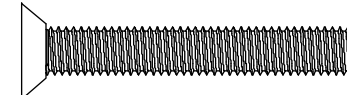

#8 x 5/8" Phillips Flat Head Screw

Usage:

Hinge

Color	PN EA
Gray	11800491
Gold	11800495

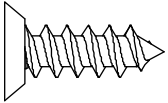

#8 x 1 1/2" Phillips Flat Head Screw

Usage:

Hinge

Color	PN EA
Gray	11800494
Gold	11800496



#6 x 2 1/2" Phillips Flat Head Screw

Usage:

Jamb strike plate installation

Color	PN EA
Brass	11800618
Stainless Steel	11800878



Mull Post

A2567

CN Height	Operation	Length	Color and Part Number						
			Stone White	Pebble	Bronze	Cashmere	Ebony	Gunmetal	*Evergreen
6-5	OX	76 3/4" (1949)	19448165	19448265	19448365	19448565	19448965	19848465	19448465
	XO		19448166	19448266	19448366	19448566	19448966	19848466	19448466
6-8	OX	79 1/4" (2013)	19448168	19448268	19448368	19448568	19448968	19848468	19448468
	XO		19448169	19448269	19448369	19448569	19448969	19848469	19448469
7-0	OX	83 1/4" (2115)	19448170	19448270	19448370	19448570	19448970	19848470	19448470
	XO		19448171	19448271	19448371	19448571	19448971	19848471	19448471
8-0	OX	92 3/4" (2356)	19448180	19448280	19448380	19448580	19448980	19848480	19448480
	XO		19448181	19448281	19448381	19448581	19448981	19848481	19448481

Suggested Fasteners	PN
12 - #8 x 5/8" Phillips A/Tek pan head screws	11800498

NOTE: *DISC (LA) used prior to 10/29/2022

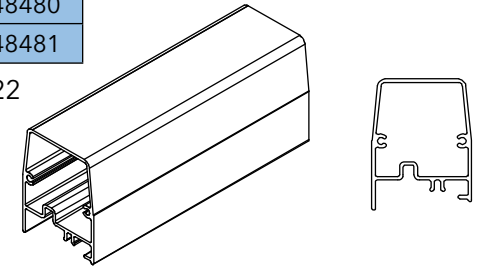

Astragal Cap

A2815

Usage dates:

08/29/2016 to present

CN Height	Length	Color and Part Number						
		Stone White	Pebble	Bronze	Cashmere	Ebony	Gunmetal	*Evergreen
6-5	75 1/4" (1911)	19456765	19456865	19456965	19457165	19457565	19857065	19457065
6-8	77 3/4" (1975)	19456768	19456868	19456968	19457168	19457568	19857068	19457068
7-0	81 3/4" (2076)	19456770	19456870	19456970	19457170	19457570	19857070	19457070
8-0	91 1/4" (2318)	19456780	19456880	19456980	19457180	19457580	19857080	19457080

Suggested Fasteners	PN
12 - #8 x 5/8" Phillips A/Tek pan head screws	11800498

NOTE: *DISC (LA) used prior to 10/29/2022

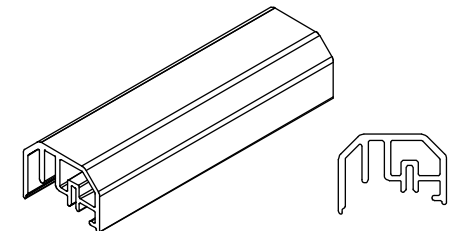

Astragal/Mull Post Base

A2571

Includes:

13 - #8 x 5/8" Phillips pan head screws (11800498)

Usage dates:

08/29/2016 to present

CN Height	Length	LH	RH
6-5	75 1/4" (1911)	11891266	11891265
6-8	77 3/4" (1975)	11891269	11891268
7-0	81 3/4" (2076)	11891271	11891270
8-0	91 1/4" (2318)	11891281	11891280

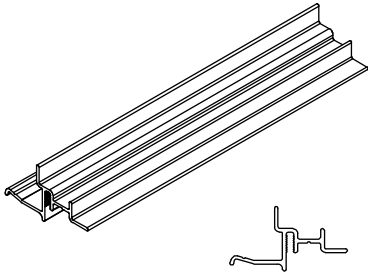

Astragal Cap - Exterior

A1431

Usage dates:

06/1999 - 08/29/2016

CN Height	Length	Color and Part Number					
		Stone White	Pebble	Bronze	Evergreen	Cashmere	Ebony
6-5	75 7/16" (1916)	11896961	11896964	11896967	11896970	11896973	11898965
6-8	77 15/16" (1980)	11896962	11896965	11896968	11896971	11896974	11898968
7-0	81 15/16" (2081)	11892970	11893970	11894970	11895970	11897970	11898970
8-0	91 7/16" (2323)	11896963	11896966	11896969	11896972	11896975	11898980

Suggested Fasteners	PN
8 - #8 x 5/8" Phillips pan head screws	11800498

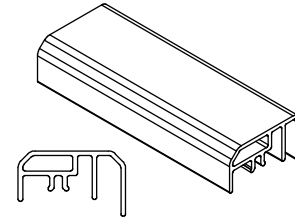

Sill Liner

V2736

Usage dates:

10/29/2018 to present

NOTE: Foam sealant tape included

CN Width	Length	Beige PN	Black PN
2-6	30 5/16" (770)	11891526	11891426
2-8	32 5/16" (821)	11891528	11891428
3-0	36 5/16" (923)	11891530	11891430
5-0	59" (1499)	11891550	11891450
5-4	63" (1600)	11891554	11891454
6-0	71" (1803)	11891560	11891460

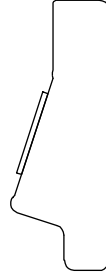

Sill Liner - HP/IZ3

V2960

Usage dates:

10/29/2018 to present

NOTE: Foam sealant tape included

CN Width	Length	Beige PN	Black PN
2-6	30 5/16" (770)	11891726	11891626
2-8	32 5/16" (821)	11891728	11891628
3-0	36 5/16" (923)	11891730	11891630
5-0	59" (1499)	11891750	11891650
5-4	63" (1600)	11891754	11891654
6-0	71" (1803)	11891760	11891660

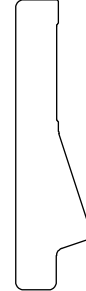

Sill Liner, 6 13/16"

V2934

Usage dates:

10/29/2018 to present

NOTE: Foam sealant tape included

CN Width	Length	Beige PN	Black PN
3-0	36 5/16" (923)	31606930	31506930
6-0	71" (1803)	31606960	31506960

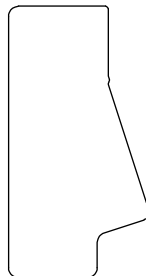

Sill Liner - HP/IZ3, 6 13/16"

V2954

Usage dates:

10/29/2018 to present

NOTE: Foam sealant tape included

CN Width	Length	Beige PN	Black PN
6-0	71" (1803)	11101171	31511171

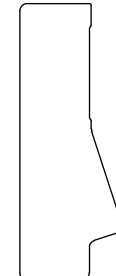

Standing Block, Stationary

V2055

Usage dates:

07/30/2012 - 08/29/2016

NOTE: Clear double sided tape for installation included.

CN width	Length	PN
5-0	26" (660)	10501151
5-4	28" (711)	10501155
6-0	32" (813)	10501161

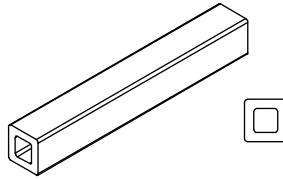

Panel Sweep

V1890

Usage dates:

08/31/2009 - 08/29/2016

NOTE: This part is handed for the actual panel it is applied to, not the handing of the entire unit.

Secondary			
CN width	Length	LH PN	RH PN
2-6/5-0	28 19/32" (726)	15919351	15919350
2-8/5-4	30 19/32" (777)	15919355	15919354
3-0/6-0	35 19/32" (879)	15919361	15919360

Primary		
CN width	Length	PN
2-6/5-0	28 39/64" (726)	15919450
2-8/5-4	30 39/64" (777)	15919454
3-0/6-0	34 39/64" (879)	15919460

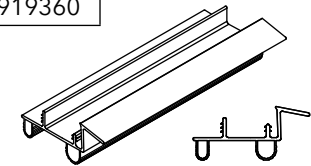

Sill Ramp, XX, OX/XO

V1892

Usage dates:

08/31/2009 - 08/29/2016

NOTE: V1892 can be used as a substitute for V794 sill weather strip.

CN width	Length	PN
2-6	28 29/32" (734)	15919526
2-8	30 29/32" (785)	15919528
3-0	34 29/32" (887)	15919530
5-0	57 5/8" (1464)	15919550
5-4	61 5/8" (1565)	15919554
6-0	69 5/8" (1768)	15919560

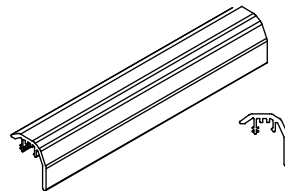

Operator Panel Shipping Block

V022

3" x 7/8" x 11/32"

Usage dates:

Prior to 08/31/2009

NOTE: Rigid PVC with 2-sided adhesive foam tape attached. 2 per stationary panel.

Color	PN
Beige	11860138

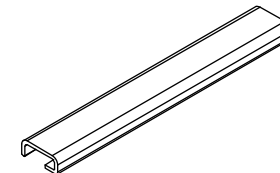

Panel Drip

V1237

Usage dates:

03/01/2004 - 08/31/2009

CN width	Length	Beige PN
2-6/5-0	28 19/32" (726)	15918150
2-8/5-4	30 19/32" (777)	15918154
3-0/6-0	35 19/32" (879)	15918160

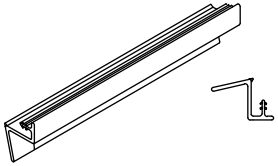

Stationary Panel Setting Block

V1278

Usage dates:

Used prior to 08/31/2009

Color	PN
Beige	10500166

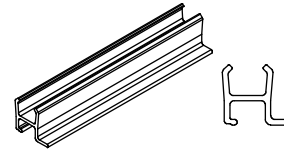

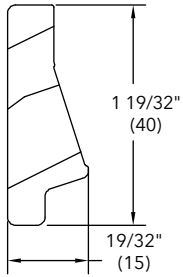

Oak Sill Liner

Usage dates: 08/29/2016 to 10/29/2018

Replace with V2736

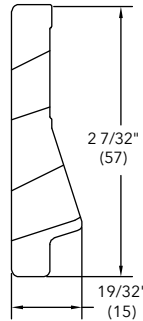

Oak Sill Liner - HP/IZ3

Usage dates: 08/29/2016 to 10/29/2018

Replace with V2960

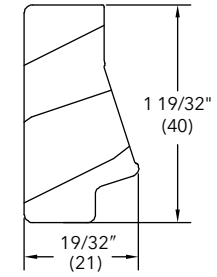

Oak Sill Liner for 6 13/16" Jamb

Usage dates: 08/29/2016 to 10/29/2018

Replace with V2934

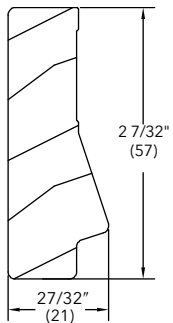

Oak Sill Liner - HP/IZ3 for 6 13/16" Jamb

Usage dates: 08/29/2016 to 10/29/2018

Replace with V2954

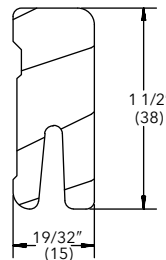

Oak Sill Liner

Usage dates: 08/31/2009 to 08/29/2016

Replace with V2935

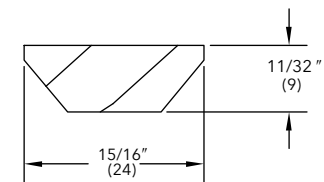

Stationary Panel Setting Block

Discontinued 07/30/2012.

Replace with V2055

Weather Strip

V2350

Used at Head Jamb/Jamb/Astragal/Mull Post

Usage dates:

08/29/2016 to present

NOTE: Weather strip has square end cuts.

Head Jamb		
CN Width	Length	Black PN
2-6	27 1/32" (687)	15971026
2-8	29 1/32" (737)	15971028
3-0	33 1/32" (839)	15971030
5-0	55 23/32" (1415)	15971050
5-4	59 23/32" (1517)	15971054
6-0	67 23/32" (1720)	15971060
Jamb		
CN Height	Length	Black PN
6-5	76 25/32" (1950)	15971065
6-8	79 9/32" (2014)	15971068
7-0	83 9/32" (2115)	15971070
8-0	92 25/32" (2357)	15971080
Astragal/Mull Post		
CN Height	Length	Black PN
6-5	75 1/4" (1911)	15971165
6-8	77 3/4" (1975)	15971168
7-0	81 3/4" (2076)	15971170
8-0	91 1/4" (2318)	15971180

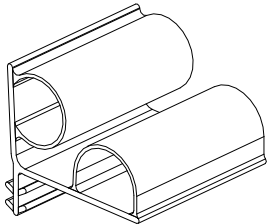

Sill Weather Strip

V2026

Usage dates:

08/29/2016 to present

NOTE: Weather strip has notched ends.

CN Width	Length	Beige PN	Black PN
2-6	28 15/16" (735)	11208826	11208926
2-8	30 15/16" (786)	11208828	11208928
3-0	34 15/16" (888)	11208830	11208930
5-0	57 5/8" (1464)	11208850	11208950
5-4	61 5/8" (1565)	11208854	11208954
6-0	69 5/8" (1768)	11208860	11208960

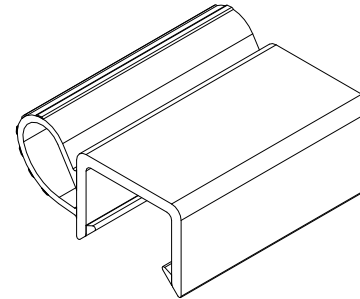

Dust Block

Usage dates:

08/29/2016 to present

Color	PN
Gray	15600010

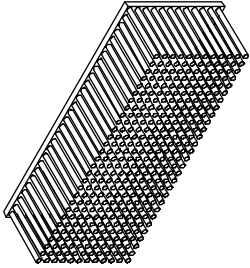

Sill Retainer, Stationary

V2460

Usage dates:

08/29/2016 to present

CN Width	Length	Color	PN
2-6/5-0	25" (635)	Black	15918550
2-8/5-4	27" (686)		15918554
3-0/6-0	31" (787)		15918560

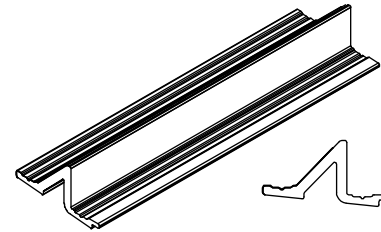

Accessory Kerf Weather Strip - Frame

5/32" diameter

NOTE: For field service only

Length	Color	PN
25' (7620)	Beige	15910125

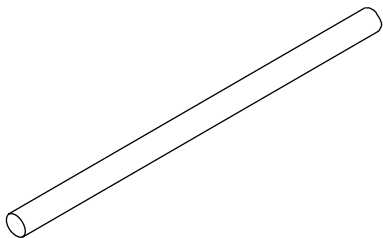

Stationary Jamb Retainer

V2547

Usage dates:

08/29/2016 to present

Length	Color	PN
12" (305)	Black	15916812

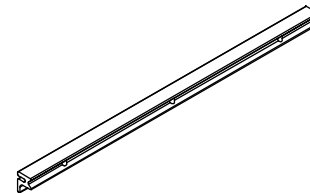

Head Jamb/Jamb/Mull Post Weather Strip

V019

NOTE: Head jamb weather strip has 45 degree cuts on each end. Jamb weather strip has one end cut square and one end cut at 45 degrees. Mullion post and astragal weather strip have a square cut on both ends.

Usage dates:

06/1999 - 08/29/2016 - Head Jamb, Jamb, Mull Post

Prior to 8/29/2009 - Astragal

Head Jamb		
CN Width	Length	Beige PN
2-6	28 29/32" (734)	15970126
2-8	30 57/64" (785)	15970128
3-0	34 29/32" (886)	15970131
5-0	57 9/16" (1462)	15970150
5-4	61 9/16" (1564)	15970154
6-0	69 9/16" (1767)	15970161

Jamb			
CN Height	Length	Beige RH PN	Beige LH PN
6-5	77 1/2" (1969)	15970265	15970266
6-8	80" (2032)	15970268	15970269
7-0	84" (2134)	15970270	15970271
8-0	93 1/2" (2375)	15970280	15970281

Mull Post		
CN Height	Length	Beige PN
6-5	77" (1956)	15970167
6-8	79 1/2" (2019)	15970172
7-0	83 1/2" (2121)	15970174
8-0	93" (2362)	15970182

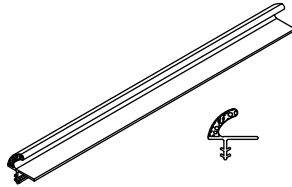

Astragal		
CN Height	Length	Beige PN
6-5	75 3/4" (1924)	15971465
6-8	78 1/4" (1988)	15971468
8-0	91 3/4" (2381)	15971480

Astragal Weather Strip

V1893

Usage dates:

08/31/2009 - 08/29/2016

CN Height	Length	PN
6-5	76 25/32" (1950)	15919366
6-8	79 9/32" (2014)	15919369
7-0	83 9/32" (2115)	15919371
8-0	92 25/32" (2357)	15919381



Jamb Weather Strip Plug

1/2" x 1/4" x 3"

NOTE: Adhesive backed foam

Usage dates:

06/1999 - 08/29/2016

Color	PN
Beige	10500158



Sill Weather Strip

V794

Usage dates:

Prior to 08/31/2009

CN Width	Length	PN
2-6	28 15/16" (735)	N/A
2-8	30 17/16" (786)	N/A
3-0	34 15/16" (887)	N/A
5-0	57 5/8" (1464)	N/A
5-4	61 5/8" (1565)	N/A
6-0	69 5/8 (1768)	15970061

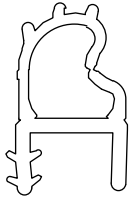

Frame Sealant, Foam, Sill Liner

1/16" x 3/8"

NOTE: Adhesive backed foam

Usage dates:

06/1999 - 08/29/2016

Length	Color	PN
Specify LF	Gray	10500142

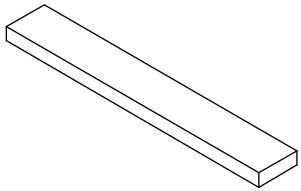

Foam Block, Panel Stop

1" x 7/8" x 1/2"

Usage dates:

06/1999 - 08/29/2016

Color	PN
Beige	10500383

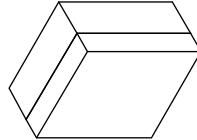

Foam Pad, Jamb/Panel

1 5/8" x 1" x 3/16"

Usage dates:

06/1999 - 08/29/2016

Color	PN
Beige	10500382

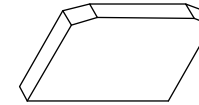

Panel Weep, Dust Block

11/16" x 13/16" x 15/32"

Usage dates:

06/1999 - 08/29/2016

Color	PN
Beige	10500381

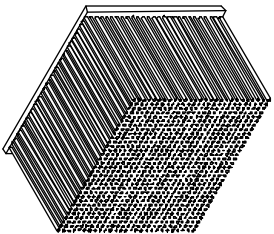

Balance Tube Foam Plug

3/4" x 3/4" x 1/2"

NOTE: Used on XO/OX configurations only

Usage dates:

06/1999 - 08/29/2016

Color	PN
White	10500104

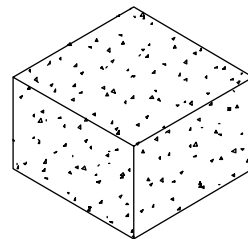

Wedge Seal

NOTE: Used on X and XO/OX configurations.

Usage dates:

06/1999 - 08/29/2016

Color	PN
Beige	01040368

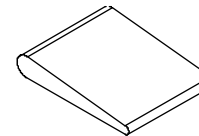

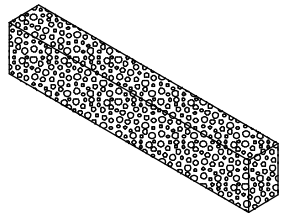

Stationary Stile Block

Used prior to 08/31/2009

No longer available

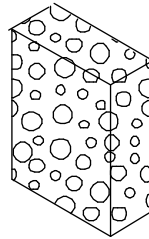

Door Stop Gasket

Used prior to 08/31/2009

No longer available

Ordering specifications (use all that apply):

1. Original order number/line number (if available)
2. Size
3. Date of frame manufacture (verify manufacture date before ordering)
4. Operator or stationary
5. Handing
6. Exterior color
7. Interior finish
8. Glazing
9. Unit option (HP, Impact). NOTE: This will affect panel height

NOTE: Operating panels include multi-point lock assembly.

NOTE: For conversion table of panels produced before 03/02/2004, refer to the obsolete parts section.

NOTE: Panel is not reglazable; replacement glass will require a new panel.

Elevate Inswing French Door Manufactured 3/1/2004 to present	
Daylight Opening to Panel OM	
Daylight Opening Width + 7 1/4" = OM Width of Panel	
Daylight Opening Height + 9 5/8" = OM Height of Panel	
Width	
CN Size	OM Width
2-6	28 19/32" (726)
2-8	30 19/32" (778)
3-0	34 19/32" (879)
5-0	28 19/32" (726)
5-4	30 19/32" (778)
6-0	34 19/32" (879)
Height	
CN Size	OM Height
6-5	76 23/32" (1949)
6-8	79 7/32" (2012)
7-0	83 7/32" (2114)
8-0	92 23/32" (2355)
HP/IZ3	
6-5	76 1/16" (1932)
6-8	78 9/16" (1995)
7-0	82 9/16" (2097)
8-0	92 1/16" (2338)

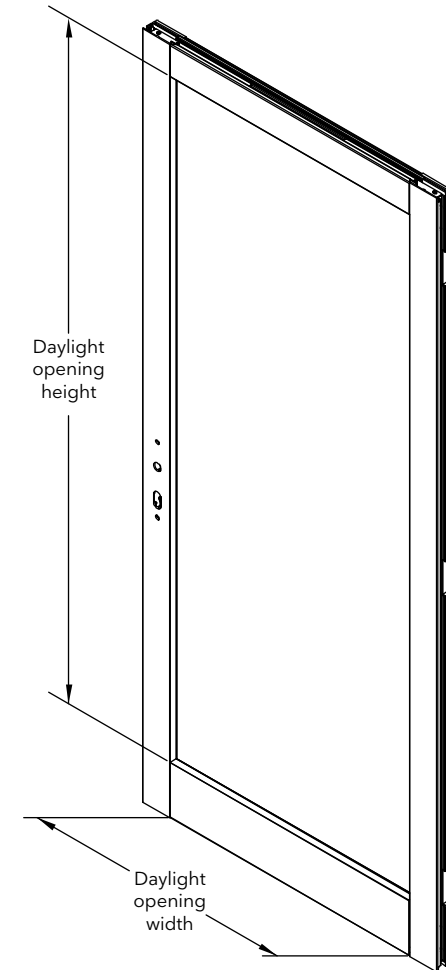

**Exterior View
(Operator panel shown)**

Ordering specifications (use all that apply):

1. Original order number/line number (if available)
2. Size
3. Date of frame manufacture (verify manufacture date before ordering)
4. Operator or stationary
5. Handing
6. Exterior color
7. Interior finish
8. Glazing

NOTE: Operating panels include multi-point lock assembly, panel sweep with gaskets, and wood backers. Stationary panels include panel sweep with gaskets, stationary panel spacer and stile foam block. Hinges are only included on stationary panels pre 3/2004.

NOTE: Panel is not reglazable; replacement glass will require a new panel.

NOTE: Configured Part in OMS

Elevate Inswing French Door Manufactured 1999 to 3/1/2004	
Daylight Opening to Panel OM	
Daylight Opening Width + 7 1/4" = OM Width of Panel	
Daylight Opening Height + 9 5/8" = OM Height of Panel	
Width	
CN Size	OM Width
2-6	28 19/32" (726)
3-0	35 3/32" (891)
5-0	28 19/32" (726)
6-0	35 3/32" (891)
Height	
CN Size	OM Height
6-8	79 7/32" (2012)

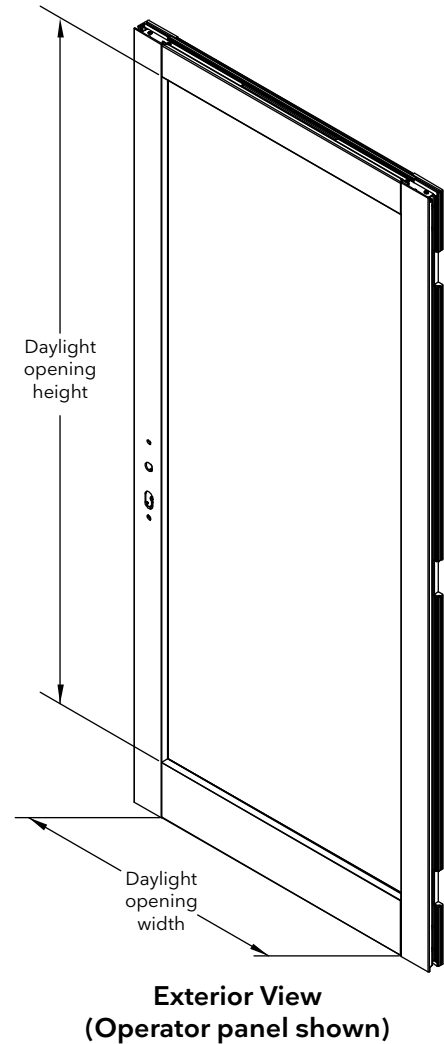

Swinging Screen Replacement - X and XX units

Screens are standard with a color matched aluminum surround. Standard mesh is Marvin Bright View™. Determine the outside measurement of the existing screen. Find the sizes that correspond to the width and height indicated on the following chart.

Ordering specifications (use all that apply):

1. Size; if there is no existing screen from which to obtain the OM of the screen, determine the size of the screen by using the conversion chart below. The daylight opening is the measurement of the visible glass. For frames manufactured prior to 03/02/2004 refer to obsolete section for screen size conversions.
2. Handing
3. Exterior color

NOTE: Swinging screens are available in X and XX configurations. Replacement swinging screens contain the following components: installation instructions, handle kit, closure kit, bottom expander and sweep, head jamb, hinge-jamb and latch-jamb z bar. XX configurations also include astragal kit.

Screen Sizes for Inswing French Door Manufactured 3/1/2004 to 08/29/2016		
Daylight Opening to OM of Screen		
X - Daylight Opening Width + 7 1/8" (181) = OM Width of Screen		
XX - Daylight Opening Width + 6 7/8" (175) = OM Width of Screen		
Daylight Opening Height + 10 1/4" (260) = OM Height of Screen		
Width		
CN Size	X - OM Width	XX - OM Width
2-6	28 7/16" (723)	N/A
2-8	30 7/16" (773)	N/A
3-0	34 7/16" (876)	N/A
5-0	N/A	28 1/8" (714)
5-4	N/A	30 1/8" (765)
6-0	N/A	34 1/8" (867)
Height		
CN Size	OM Height	
6-5	77 3/8" (1965)	
6-8	79 7/8" (2029)	
7-0	83 7/8" (2130)	
8-0	93 3/8" (2372)	

Screen Sizes for Inswing French Door Manufactured 08/29/2016 to present		
Daylight Opening to OM of Screen		
X - Daylight Opening Width + 7 1/8" (181) = OM Width of Screen		
XX - Daylight Opening Width + 6 7/8" (175) = OM Width of Screen		
Daylight Opening Height + 10 1/8" (257) = OM Height of Screen		
Width		
CN Size	X - OM Width	XX - OM Width
2-6	28 7/16" (723)	N/A
2-8	30 7/16" (773)	N/A
3-0	34 7/16" (876)	N/A
5-0	N/A	28 1/8" (714)
5-4	N/A	30 1/8" (765)
6-0	N/A	34 1/8" (867)
Height		
CN Size	OM Height	
6-5	77 1/4" (1962)	
6-8	79 3/4" (2026)	
7-0	83 3/4" (2127)	
8-0	93 1/4" (2369)	

Handle Kit, Complete

Includes:

Latch handles and related parts,
Z-bar mounting screws and installation instructions

Usage dates:

2003 to present

Color	PN
Black	11901970

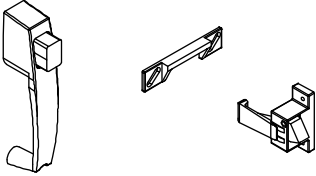

Screen Door Closer Kit

Includes:

Cylinder brackets, pins, hold-open washer,
screws and installation instructions.

Usage dates:

1999 to present

PN
11901971

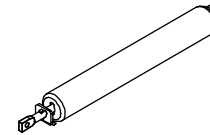

Shoot Bolt Receiver, Swinging Screen 4 9/16" and 6 9/16"

Includes:

1 - Receiver
1 - Dust Block
1 - #8 x 1/2" pan head stainless steel screw (11800532)

Usage dates:

08/29/2016 to present

Color	PN
Black	11892701

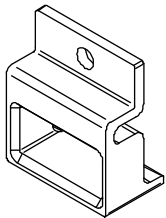

Mounting Plate, Closer Bracket, Swinging Screen

PN
11860177

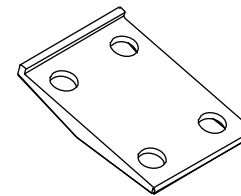

Swinging Screen Astragal Kit

Includes:

Astragal, Vinyl Trim Pieces, Shoot Bolt Assembly, Shoot Bolt Receiver with Dust Block

Usage dates:

08/29/2016 to present

CN Height	Length	Color and Part Number						
		Stone White	Pebble	Bronze	Cashmere	Ebony	Gunmetal	*Evergreen
6-5	77 1/4" (1962)	11960965	11960865	11960765	11960566	11961265	11980666	11960666
6-8	79 3/4" (2025)	11960968	11960868	11960768	11960569	11961268	11980669	11960669
7-0	83 3/4" (2127)	11960870	11960770	11960671	11960471	11961270	11980571	11960571
8-0	93 1/4" (2368)	11960980	11960880	11960780	11960581	11961280	11980681	11960681

Suggested Fasteners	PN
2 - #6 x 3/4" Phillips pan head screws	11860866

NOTE: *DISC (LA) used prior to 10/29/2022

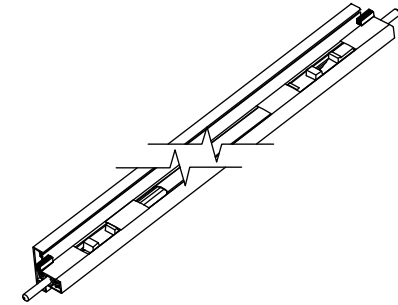

Pile, Door Screen Replacement, Swinging Screen

PN
10600251

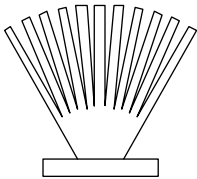

Vinyl Sweep

1/8" x 3/4" x 36"

Usage:

2004 to present

Color	PN
Black	11860160

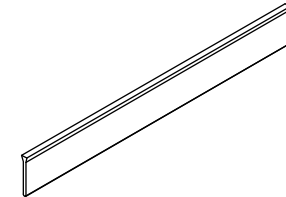

Bottom Expander

Usage dates:

03/2004 to present

CN Width	Length	Color and Part Number						
		Stone White	Pebble	Bronze	Cashmere	Ebony	Gunmetal	*Evergreen
2-6/5-0	28 9/16" (726)	17037026	17017126	17037126	17037426	17037526	17087326	17037326
2-8/5-4	30 9/16" (776)	17037028	17017128	17037125	17037428	17037525	17087328	17037328
3-0/6-0	34 9/16" (878)	17037031	17017131	17047169	17047132	17047133	17087131	17047131

NOTE: *DISC (LA) used prior to 10/29/2022

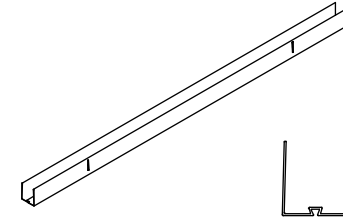

Head Jamb Screen Z-Bar

A1308

NOTE: Head jamb screen Z-bars have 45 degree cuts on both ends (non handed).

Usage dates:

03/2004 to present

CN Width	Length	Color and Part Number						
		Stone White	Pebble	Bronze	Cashmere	Ebony	Gunmetal	*Evergreen
2-6	29 11/16" (754)	17037226	17017326	17047226	17047426	17047525	17847326	17047326
2-8	31 11/16" (805)	17037228	17017328	17047228	17047428	17047528	17847328	17047328
3-0	35 11/16" (906)	17037231	17017331	17047231	17047431	17047531	17847331	17047331
5-0	58 3/8" (1483)	17037250	17017350	17047250	17047450	17047550	17847350	17047350
5-4	62 3/8" (1584)	17037254	17017354	17047254	17047454	17047554	17847354	17047354
6-0	70 3/8" (1788)	17037260	17017360	17047260	17047460	17047560	17847360	17047360

NOTE: *DISC (LA) used prior to 10/29/2022

Suggested Fasteners	PN
#8 x 5/8" Phillips flat head screws	11805180
3 on 3-0 and under, 4 on 4-0 and over	

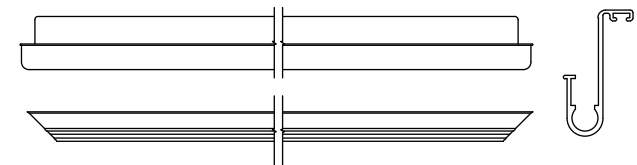

Jamb-Hinge Screen Z-Bar

A1308

NOTE: Jamb-Hinge screen Z-bars have 45 degree cuts on one end and square cuts on the other. Handing is determined from the exterior. Left hand shown.

Usage dates:

08/29/2016 to present

CN Height	Length	Handing	Color and Part Number						
			Stone White	Pebble	Bronze	Cashmere	Ebony	Gunmetal	*Evergreen
6-5	78 9/16" (1995)	LH	18037266	18017366	18047266	18047666	18047866	18847366	18047366
		RH	18037265	18017365	18047265	18047665	18047865	18847365	18047365
6-8	81 1/16" (2059)	LH	18037269	18017369	18047269	18047669	18047869	18847369	18047369
		RH	18037268	18017368	18047268	18047668	18047868	18847368	18047368
7-0	85 1/16" (2161)	LH	18037271	18017371	18047271	18047671	18047871	18847371	18047371
		RH	18037270	18017370	18047270	18047670	18047870	18847370	18047370
8-0	94 9/16" (2402)	LH	18037281	18017381	18047281	18047681	18047881	18847381	18047381
		RH	18037280	18017380	18047280	18047680	18047880	18847380	18047380

Suggested Fasteners	PN
#8 x 5/8" Phillips flat head screws	11805180
8 - Frame Size < 87 15/16"	
10 - Frame size => 87 15/16"	

NOTE: *DISC (LA) used prior to 10/29/2022

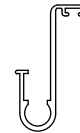
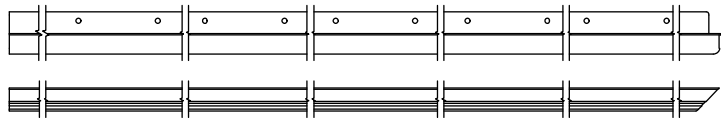

Jamb-Latch Screen Z-Bar

A1308

NOTE: Jamb-Hinge screen Z-bars have 45 degree cuts on one end and square cuts on the other. Handing is determined from the exterior. Left hand shown.

Usage dates:

08/29/2016 to present

CN Height	Length	Handing	Color and Part Number						
			Stone White	Pebble	Bronze	Cashmere	Ebony	Gunmetal	*Evergreen
6-5	78 9/16" (1995)	LH	18037466	18017566	18047466	18047766	18047966	17847566	18047566
		RH	18037465	18017565	18047465	18047765	18047965	17847565	18047565
6-8	81 1/16" (2059)	LH	18037469	18017569	18047469	18047769	18047969	17847569	18047569
		RH	18037468	18017568	18047468	18047768	18047968	17847568	18047568
7-0	85 1/16" (2161)	LH	18037471	18017571	18047471	18047771	18047971	17847571	18047571
		RH	18037470	18017570	18047470	18047770	18047970	17847570	18047570
8-0	94 9/16" (2402)	LH	18037481	18017581	18047481	18047781	18047981	17847581	18047581
		RH	18037480	18017580	18047480	18047780	18047980	17847580	18047580

NOTE: *DISC (LA) used prior to 10/29/2022

Suggested Fasteners	PN
#8 x 5/8" Phillips flat head screws	11805180
8 - Frame Size < 87 15/16"	
10 - Frame size => 87 15/16"	

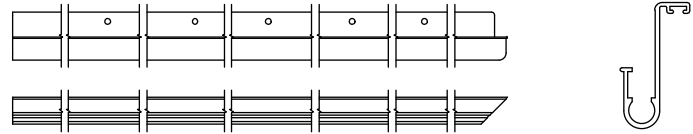

Swinging Screen Replacement - X and XX units

Screens are standard with a color matched aluminum surround. Standard mesh is Marvin Bright View™. Determine the outside measurement of the existing screen. Find the sizes that correspond to the width and height indicated on the following chart.

Ordering specifications (use all that apply):

1. Size; if there is no existing screen from which to obtain the OM of the screen, determine the size of the screen by using the conversion chart below. The daylight opening is the measurement of the visible glass. For frames manufactured prior to 03/02/2004 refer to obsolete section for screen size conversions.
2. Handing
3. Exterior color

NOTE: Swinging screens are available in X and XX configurations. Replacement swinging screens contain the following components: installation instructions, handle kit, closure kit, bottom expander and sweep, head jamb, hinge-jamb and latch-jamb z bar. XX configurations also include astragal kit.

NOTE: Configured Part in OMS

Screen Sizes for Inswing French Door Manufactured 1999 to 03/01/2004	
Daylight Opening to OM of Screen	
Daylight Opening Width + 7 7/32" (183) = OM Width of Screen	
Daylight Opening Height + 5 3/16" (132) = OM Height of Screen	
Width	
CN Size	OM Width
2-6	28 9/16" (725)
3-0	35 3/16" (893)
Height	
CN Size	OM Height
6-8	79 7/8" (2029)

Swinging Screen Receptacle, 4 9/16"

Includes:

- 1 - Receptacle
- 1 - Dust block

Usage dates:

06/1999 - 08/29/2016

PN
10815128

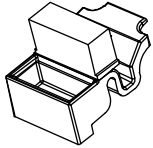

Swinging Screen Receptacle, 6 9/16"

Includes:

- 1 - Receptacle
- 1 - Dust block
- 1 - #8 x 1/2" pan head stainless steel screw, 11800532

Usage dates:

06/1999 - 08/29/2016

PN
10815129

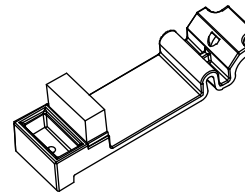

Swinging Screen Astragal Kit

Includes:

- 1 - Astragal
- 4 - Vinyl trim (outside & inside pieces),
- 2 - Shoot bolts and slides
- 5 - #6 x 3/4" Phillips pan head screws (11860866)

Usage dates:

Prior to 08/29/2016

CN Height	Length	Color and Part Number					
		Stone White	Pebble	Bronze	Cashmere	Ebony	Evergreen
6-5	77 3/8" (1965)	11860965	11860865	11860765	11860566	11861265	11860666
6-8	79 7/8" (2029)	11860968	11860868	11860768	11860569	11861268	11860669
7-0	83 7/8" (2130)	11860870	11860770	11860671	11860471	11861270	11860571
8-0	93 3/8" (2372)	11860980	11860880	11860780	11860581	11861280	11860681

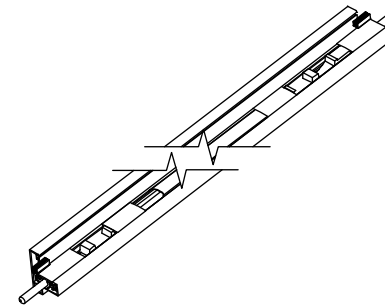

Jamb-Hinge Screen Z-Bar

NOTE: Jamb-Hinge screen Z-bars have 45 degree cuts on one end and square cuts on the other. Handing is determined from the exterior. Left hand shown.

Usage dates:

06/1999 - 08/29/2016

CN Height	Length	Handing	Color and Part Number					
			Stone White	Pebble	Bronze	Evergreen	Cashmere	Ebony
6-5	78 15/16" (2005)	LH	17037266	17017366	17047266	17047366	17047666	17047866
		RH	17037265	17017365	17047265	17047365	17047665	17047865
6-8	81 7/16" (2069)	LH	17037269	17017369	17047269	17047369	17047669	17047869
		RH	17037268	17017368	17047268	17047368	17047668	17047868
7-0	85 7/16" (2170)	LH	17037271	17017371	17047271	17047371	17047671	17047871
		RH	17037270	17017370	17047270	17047370	17047670	17047870
8-0	94 15/16" (2411)	LH	17037281	17017381	17047281	17047381	17047681	17047881
		RH	17037280	17017380	17047280	17047380	17047680	17047880

Suggested Fasteners	PN
#8 x 5/8" Phillips flat head screws	11805180
8 - Frame Size < 87 15/16"	
10 - Frame size =< 87 15/16"	

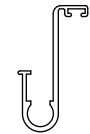
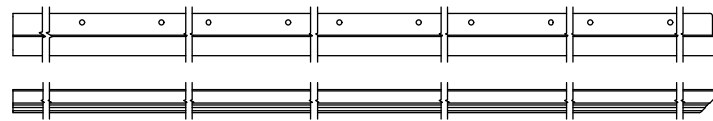

Jamb-Latch Screen Z-Bar

NOTE: Jamb-Hinge screen Z-bars have 45 degree cuts on one end and square cuts on the other. Handing is determined from the exterior. Left hand shown.

Usage dates:

06/1999 - 08/29/2016

CN Height	Length	Handing	Color and Part Number					
			Stone White	Pebble	Bronze	Evergreen	Cashmere	Ebony
6-5	78 15/16" (2005)	LH	17037466	17017566	17047466	17047566	17047766	17047966
		RH	17037465	17017565	17047465	17047565	17047765	17047965
6-8	81 7/16" (2069)	LH	17037469	17017569	17047469	17047569	17047769	17047969
		RH	17037468	17017568	17047468	17047568	17047768	17047968
7-0	85 7/16" (2170)	LH	17037471	17017571	17047471	17047571	17047771	17047971
		RH	17037470	17017570	17047470	17047570	17047770	17047970
8-0	94 15/16" (2411)	LH	17037481	17017581	17047481	17047581	17047781	17047981
		RH	17037480	17017580	17047480	17047580	17047780	17047980

Suggested Fasteners	PN
#8 x 5/8" Phillips flat head screws	11805180
8 - Frame Size < 87 15/16"	
10 - Frame size =< 87 15/16"	

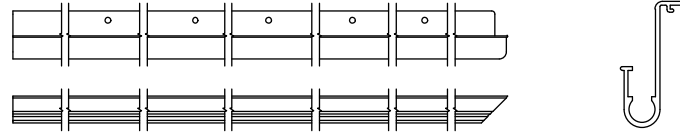

Sliding Screen Replacement

Screens are standard with a color matched aluminum surround. Standard mesh is Marvin Bright View™. Determine the outside measurement of the existing screen. Find the sizes that correspond to the width and height indicated on the following chart.

Ordering specifications (use all that apply):

1. Size; if there is no existing screen from which to obtain the OM of the screen, determine the size of the screen by using the conversion chart below. The daylight opening is the measurement of the visible glass. For frames manufactured prior to 03/02/2004 refer to obsolete section for screen size conversions.
2. Handing
3. Exterior color

NOTE: 02/14/2020: The screen handle position was changed to a height dimension of 38" from the bottom of the screen to the center of the handle.

Screen Sizes for Inswing French Door Manufactured 3/1/2004 to 08/29/2016	
Daylight Opening to OM of Screen	
Daylight Opening Width + 4 3/16" (106) = OM Width of Screen	
Daylight Opening Height + 5 3/16" (132) = OM Height of Screen	
Width	
CN Size	OM Width
5-0	29 3/16"
5-4	31 3/16"
6-0	35 3/16"
Height	
CN Size	OM Height
6-5	77 3/4"
6-8	80 1/4"
7-0	84 1/4"
8-0	93 3/4"

Screen Sizes for Inswing French Door Manufactured 08/29/2016 to present	
Daylight Opening to OM of Screen	
Daylight Opening Width + 4 3/16" (106) = OM Width of Screen	
Daylight Opening Height + 4 1/2" (114) = OM Height of Screen	
Width	
CN Size	OM Width
5-0	29 3/16"
5-4	31 3/16"
6-0	35 3/16"
Height	
CN Size	OM Height
6-5	77 1/32"
6-8	80 17/32"
7-0	84 17/32"
8-0	93 1/32"

Head Jamb Screen Track

A1237

Usage dates:

03/2004 to present

CN Width	Length	Color and Part Number						
		Stone White	Pebble	Bronze	Cashmere	Ebony	Gunmetal	*Evergreen
5-0	57 31/64" (1460)	11897145	11897146	11897147	11897149	11898150	18847050	11897148
5-4	61 31/64" (1562)	11897166	11897167	11897168	11897170	11897171	18847054	11897169
6-0	69 31/64" (1766)	11897150	11897151	11897152	11897154	11898155	18847055	11897153

Suggested Fasteners	PN
6 - #8 x 5/8" Phillips self tapping undercut truss head screws	11806158

NOTE: *DISC (LA) used prior to 10/29/2022

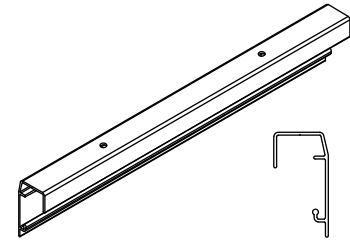

Screen Handle Assembly

Includes:

- 1 - Exterior handle - A
- 1 - Interior handle - B
- 1 - Slide - C
- 1 - Latch - D
- 3 - Screws
- 1 - Rivet

Color	PN
Black	10150028

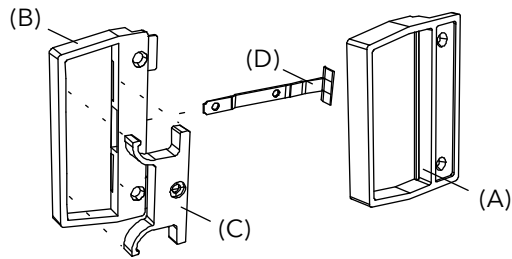

Screen Door Meeting Stile Dust Block

17/32" x 7/8" x 1/2" (13x22x13)

NOTE: Adhesive backed

Color	PN
Gray	10500161

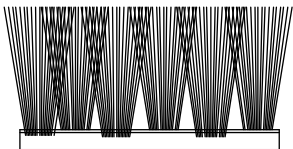

Screen Roller Guide

V2932

Color	CN	PN
Black	5-0/7-6/10-0	15918851
	6-0/9-0/12-0 (4 panel)	15918861
	8-0/12-0 (3 panel)/16-0	15918881

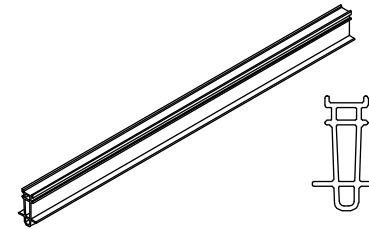

Screen Door Strike Kit

Includes:

- 1 - #8 x 5/8" Phillips pan head screw

PN
11897165

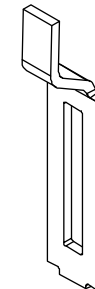

Screen Bumper

3/4" x 3/4" x 1 3/8"

PN
02540675

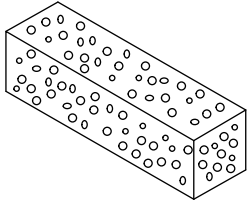

Screen Roller Assembly

Includes:

- 2 - Rollers
- 2 - Machine screws
- 2 - Grommet washers

PN
11869525

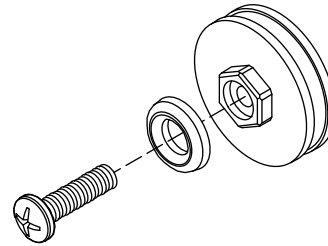

Screen Pile Weather Strip, Sliding Screen

PN
10600252

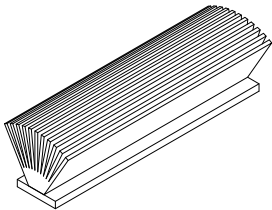

Screen Roller Track Dust Block

7/8" x 7/8" x 3/16"

NOTE: Adhesive backed, located behind the screen roller bar

Color	PN
Gray	10500143



Sliding Replacement Screens - OX/XO units

Screens are standard with a color matched aluminum surround. Standard mesh is Marvin Bright View™. Determine the outside measurement of the existing screen. Find the sizes that correspond to the width and height indicated on the following chart.

Ordering specifications (use all that apply):

1. Size; if there is no existing screen from which to obtain the OM of the screen, determine the size of the screen by using the conversion chart below. The daylight opening is the measurement of the visible glass. For frames manufactured prior to 03/02/2004 refer to obsolete section for screen size conversions.
2. Handing
3. Exterior color

NOTE: 02/14/2020: The screen handle position was changed to a height dimension of 38" from the bottom of the screen to the center of the handle.

NOTE: Configured Part in OMS

Screen Sizes for Inswing French Door Manufactured 1999 to 2003	
Daylight Opening to OM of Screen	
Daylight Opening Width + 7 27/32" (199) = OM Width of Screen	
Daylight Opening Height + 9 13/32" (239) = OM Height of Screen	
Width	
CN Size	OM Width
5-0	29 3/16" (741)
6-0	35 11/16" (906)
Height	
CN Size	OM Height
6-8	79 5/16" (2015)

Screen Sizes for Inswing French Door Manufactured 2003 to 03/01/2004	
Daylight Opening to OM of Screen	
Daylight Opening Width + 7 27/32" (199) = OM Width of Screen	
Daylight Opening Height + 10 9/16" (268) = OM Height of Screen	
Width	
CN Size	OM Width
5-0	29 3/16" (741)
6-0	35 11/16" (906)
Height	
CN Size	OM Height
6-8	80 1/4" (2038)

ATTENTION: The Elevate Swinging Door Sliding screen profile changed between February 2002 and May 2003.

- White screen profiles changed on 2/4/2002, along with a color change from Arctic White* to Stone White. The roller bar (A213) and screen track (A214) were still used.
- On 5/6/2003 Stone White and Pebble screens changed to the new profile but use an integral roller bar instead of the old A213 roller bar and A214 screen track.
- Refer to illustrations below to identify screen type.

Pre 2/4/02



2/4/02 to 5/5/03



5/6/03 to Present



Bottom Rail Guide Bar

V552

Color	Length	PN
Black	74" (1880)	15660574

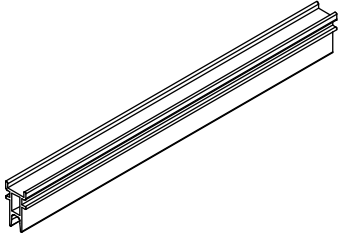

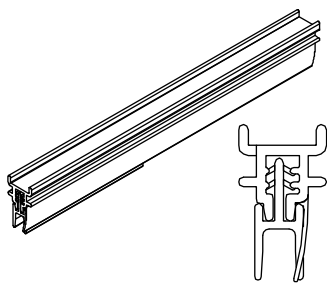

Screen Roller Guide Assembly
Usage dates: 06/1999 to 08/29/2016
Replace with V552