

# Sliding Door Automatic Control Device

## Installation Instructions

---

**ABSTRACT:** Use this site prep guide in conjunction with the Sliding Door Automatic Control Site Prep Instruction. Install the door prior to installing the motor. The following instructions assume the installer has prior product and installation training before attempting to install the device.

### IMPORTANT

The motor and control box are complete units and must not be disassembled in the field.

---

## Table of Contents

---

- Tools Needed ..... 1
- Door/Stud/Motor Cavity Prep ..... 2
- Wiring Prep ..... 3
- Install the Pulley Corner Key ..... 4
- Install the Motor ..... 5
- Installing a Marvin Connected Home Module to Motor ..... 7
- Install the Control Box ..... 9
- Connecting Components ..... 11
- Modern Multi-Slide Door Connections ..... 13
- Threading the Belt ..... 16
- Installing the Optional Closing Ramp ..... 20
- Optional Belt Clips ..... 21
- Programming ..... 22
- Reprogramming ..... 23

## Tools Needed

- 14 gauge cable crimper
- Wire stripper
- Power drill/driver
- 1 1/4" drill bit
- 7/64" drill bit
- 9/64" Allen Wrench
- 3/32" Allen wrench
- Measuring tape
- Heavy duty shear (for cutting the belt)
- Extended #2 Phillips bit
- Safety glasses

### **WARNING!**

Always practice safety! Wear the appropriate eye, ear, and hand protection, especially when working with power tools.

---

## Door/Stud/Motor Cavity Prep

There are two options to consider when prepping the stud cavity to accept the drive belt.

1. Option A: Drill into the stud adjacent to the interior most track of the door with a 1 1/4" hole saw. [See Figure 1.](#)

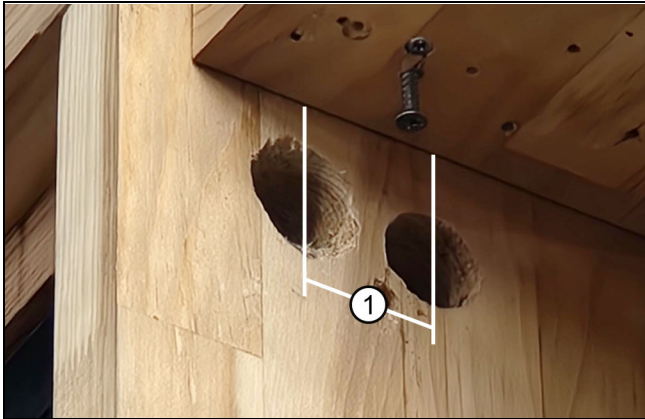

Figure 1

1	1 3/4" on center lined up with the corner key.
---	--

2. Option B: Measure the height of your door and cut a 1 1/4" x 2 1/2" deep notch lined up with the belt pass-through on the corner key. When installation is complete cover the notch with a steel tie plate. [See Figure 2.](#)

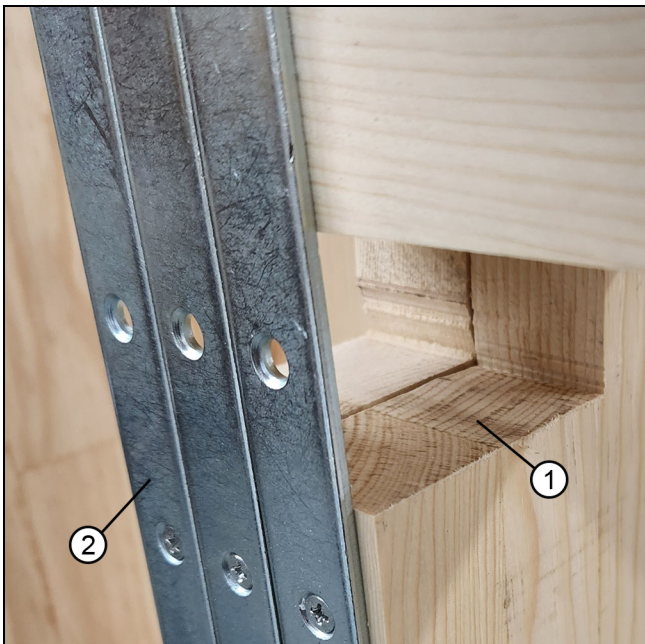

Figure 2 Notched stud

1	Steel stud tie
2	Notch

# Wiring Prep

## Wiring Included

The following supplies are included with your motor but may be supplied locally. If CAT5e cables are locally supplied they MUST be shielded.

- 18" system power cable
- 100' and 10' of red CAT5e "Super Cable"
- 100' 14-2 motor power cable (cable crimps included)
- 75' and 10' of blue CAT5e cable
- 25' of yellow CAT5e cable

## Wiring Diagram-Modern

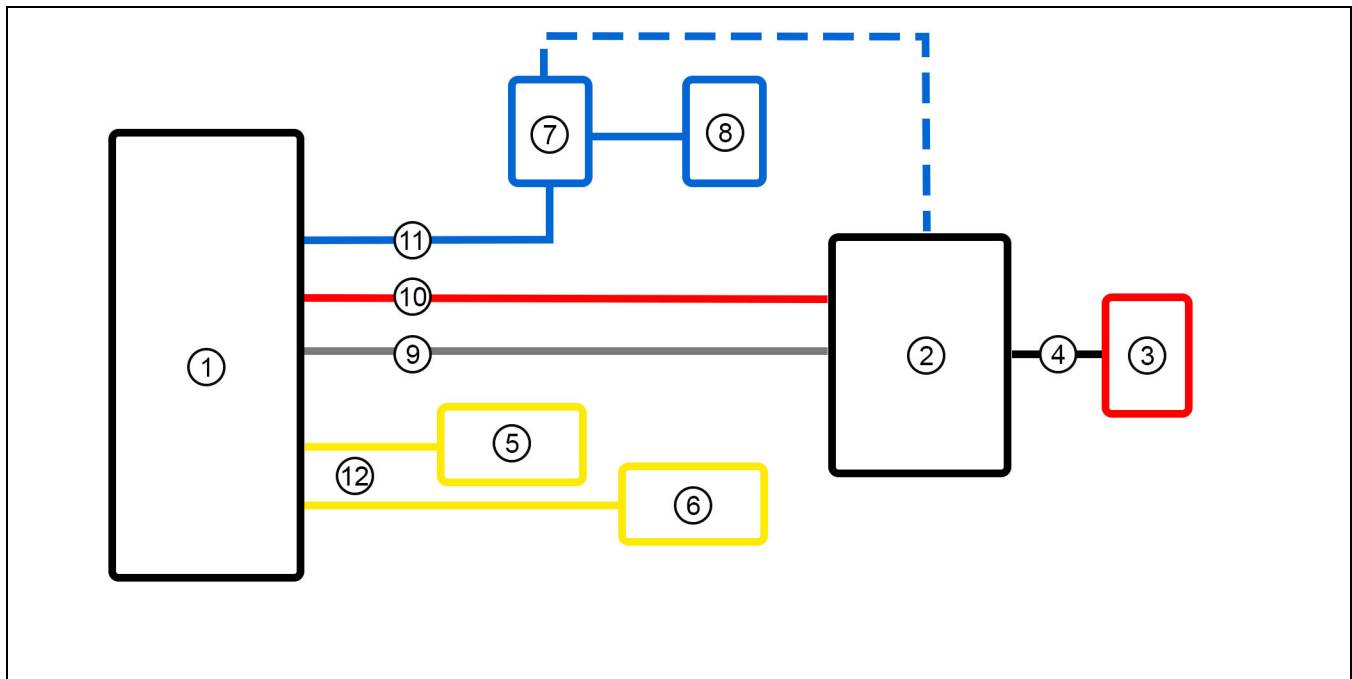

Figure 3 WILL UPDATE IMAGE WITH VECTORS 2nd image for wiring diagram for Ultimate

1	Motor
2	Control Box
3	110 volt outlet dedicated 15 amp circuit
4	Power cable from outlet to control box (if recessed, the control box must be hardwired).
5	Sensor 1:
6	Sensor 2
7	Interior wall switch
8	Exterior wall switch
9	14-2 Power cable run from control box to motor.
10	Red CAT5e "Super Cable" run from the control box to motor.
11	Blue CAT5e cable ran from the interior and exterior wall switches to the motor or controller. (Can be daisy chained)
12	Yellow CAT5e cables ran from each sensor to the motor.
13	Power cable is supplied

## Install the Pulley Corner Key

1. On ultimate MSD only: Remove the cover with a 9/64" Allen wrench. See Figure 4. Remove the bottom washer, the pulley and top washer and set aside. See Figure 5. This will give you access to the side screw holes. Attach the pulley base with two #8 x 3" screws into the side RO. See Figure 6. Replace the washers, pulley and cover in the reverse order you removed them.

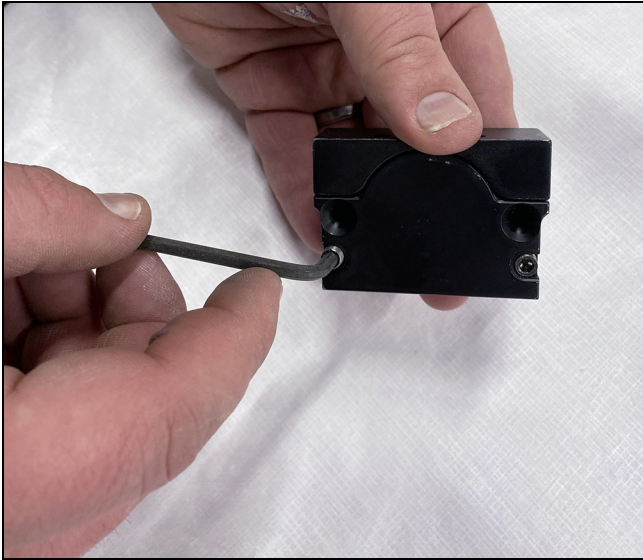

Figure 4

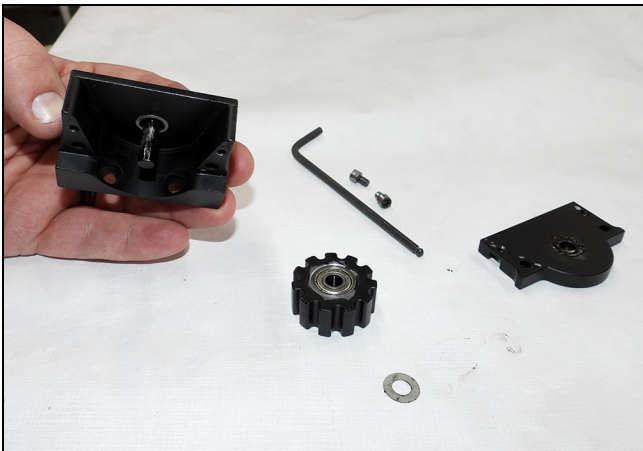

Figure 5



Figure 6

2. Make sure the corners are properly shimmed near the corners to support the corner key pulley fasteners.

3. Fasten the pulley corner key into the head jamb rough opening with two #8 x 3" screws. provided. See Figure 7.



Figure 7

1	#8 x 3" screws
---	----------------



## Install the Motor

### IMPORTANT

Check the door for proper operation before proceeding. Make the sure the panels are square and operating smoothly. Make sure you have proper head jamb clearance above the panels for the belt to travel. Make sure the locking hardware locks and engages properly.



### Hint

You will align the motor so it is centered on the lead panel. Mark a centerline in the motor cavity to aid installation. The front of the motor is the side with one stand-off at the top of the motor.

1. Install a screw on their centerline within 3" of the stud and leave the head proud about 3/4"-1".



Figure 8

2. Hang the motor by the slotted hole on the front edge of the mounting plate. See Figure 9.



Figure 9

3. Pre-drill with a 7/64" drill bit and fasten the four corners with #8x 3" screws provided

4. Set the motor drive pulley in line with the belt holes and secure the two set screws with a 3/32" Allen wrench. Adjust the pulley up or down until aligned. Then tighten the set screws. This pulley can be adjusted later to avoid belt rub.

## IMPORTANT

Make sure there is clearance below the drive pulley. (Note the area marked with a red arrow in [Figure 10](#) (next page).

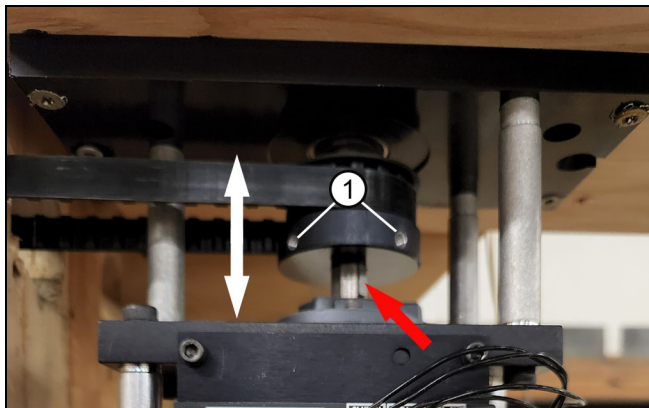

Figure 10 Drive pulley shown with belt attached

1	Set screws (2) are located at 90 degrees from each other
---	--

## Installing a Marvin Connected Home Module to Motor

### IMPORTANT

All steps must be completed with the motor powered down and unplugged.

1. Peel the backing from the VHB tape on the module. See Figure 11.

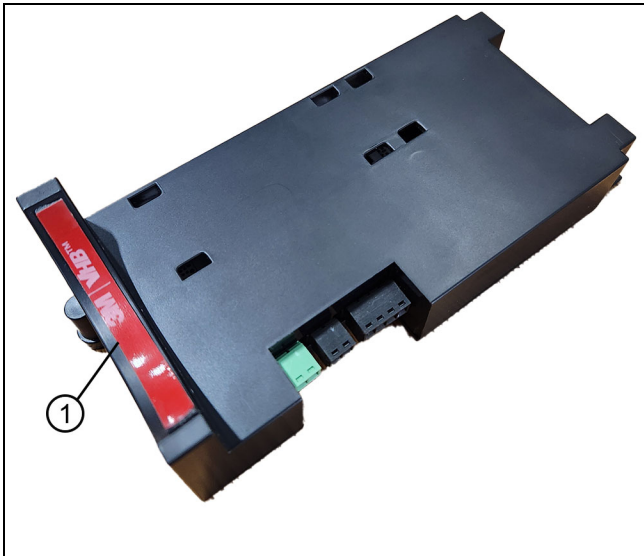

Figure 11

1	VHB tape
---	----------

2. Line module up so that the holes align with the threaded holes under the single post of the motor. See Figure 12.

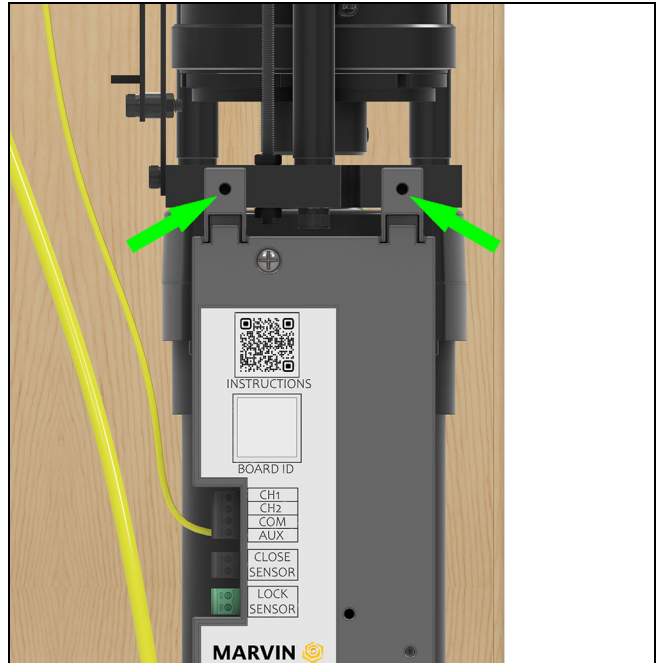

Figure 12 Green arrows pointing to threaded holes.

3. Insert and tighten provided screws. Press firmly against the bottom of the module to secure the VHB tape to the motor.

4. Connect the provided Cat5e cable to the RJ45 port labeled "MOTOR" on the bottom of the Marvin Control Module. See Figure 13 (1).

5. Connect the other end to the "WALL SWITCH" port on the motor circuit board. See Figure 13 (2).

6. Strip both ends of the provided 18" yellow wire 1/4".

7. Connect one end to the screw terminal labeled AUX on the motor circuit board and securely tighten. See Figure 13 (3).

8. Connect to the other end to the AUX port on the black 4 pin connector on the Marvin control Module. See Figure 13 (4).

### IMPORTANT

All screw terminals must be tightened to 2lb-in"

### IMPORTANT

The wire MUST be in the AUX port and not in one of the unused ports on the 4 pin connector, otherwise damage to the control board may occur.

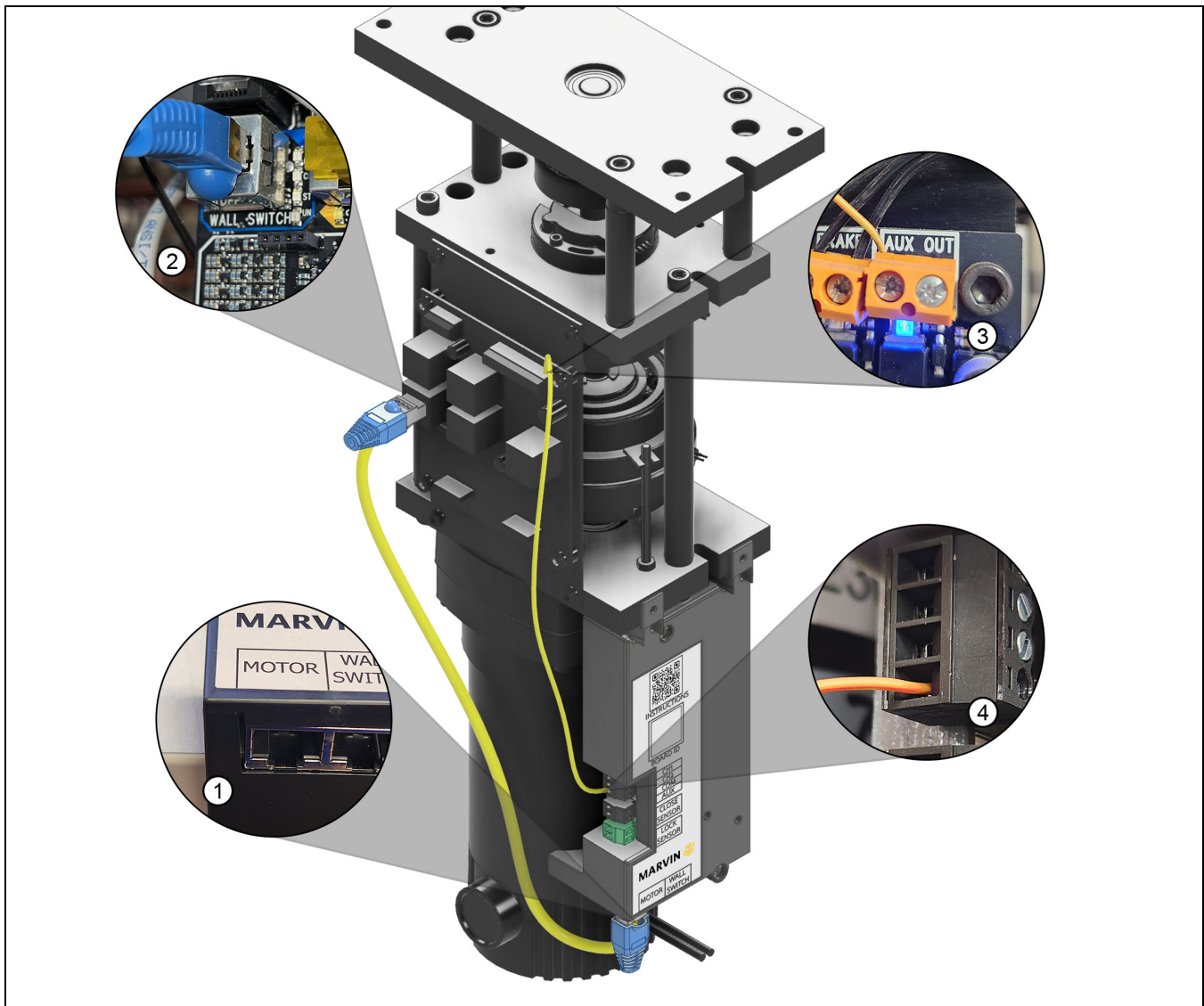

Figure 13 Motor with MCH control module installed

1	Motor port on control module
2	Wall switch on motor circuit board
3	AUX port on the motor circuit board
4	AUX port on control module



## Install the Control Box

The control box can be located within 100' of the motor. Use an accessible, well lit location in an A/V closet or utility room separate from the motor cavity. Mount the control box chest high in a well lit space.

1. On the front of the control box, make sure the AC and Battery switches are in the off position. See Figure 14.



Figure 14

2. Mount the box from the side or back using the installation keyholes on the control box and the installation screws provided. Use an extended #2 Phillips bit to aid in installation. When mounting on the back start with the bottom left screw first. Fasten all screws to securely mount the control box (4 screws for rear mount, 2 screws for side mount). See Figure 15.

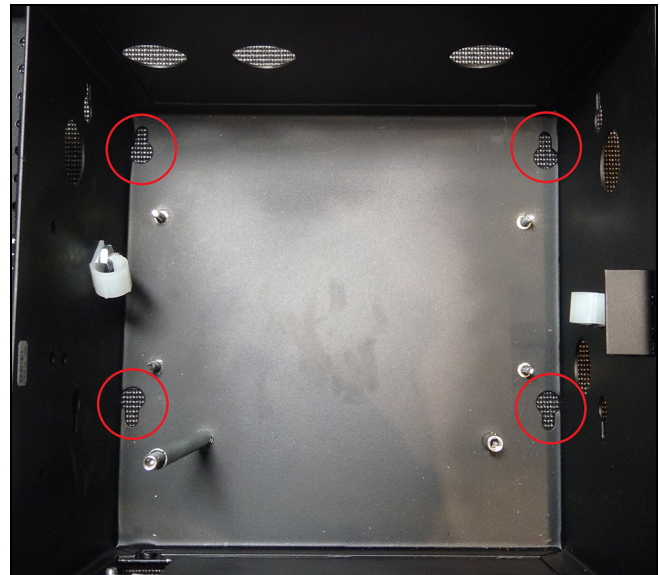

Figure 15 Rear mounting holes. Controller removed for illustrative purposes only.

3. Determine which knockouts to remove to allow power and CAT5e cables to enter the control box.

### IMPORTANT

Make sure you leave some slack in the cables before connecting to the control box. Make sure there are no tight bends in any cable.

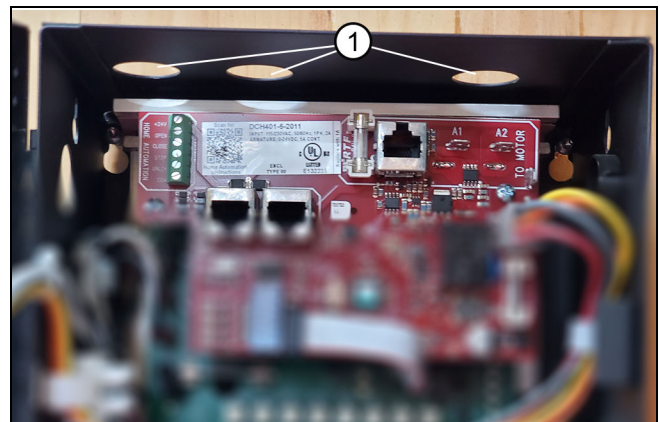

Figure 16

1	Knockouts
---	-----------

4. Pass the cables through the knockout and connect to the correct receiver. Make the following connections in the control box:

- Connect the white 14 gauge wire to the A1 port and the black 14 gauge wire to the A2 port.
- Connect the red CAT5e supercable to the corresponding connectors from the motor.
- Connect the yellow CAT5e cable to the yellow port on the motor.
- Connect the blue CAT5e cable to the blue port on the control box or motor, whichever is more accessible.

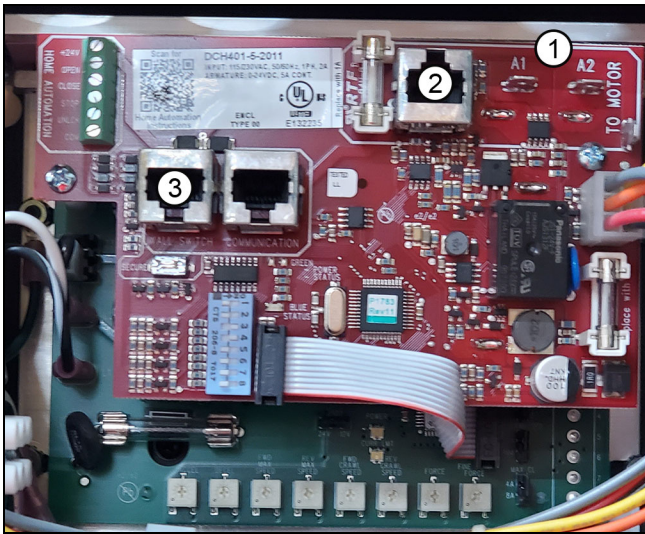

Figure 17 Control Box connections.

1	A1 and A2 ports--14 gauge wires from motor
2	Red CAT5e from motor
3	Blue CAT 5e (can be connected to control box or motor)

5. Remove the battery cover and battery from the control box. Connect the two loose red battery cables together to complete the circuit. Replace the battery and battery cover/nut. See Figure 18 and Figure 19.

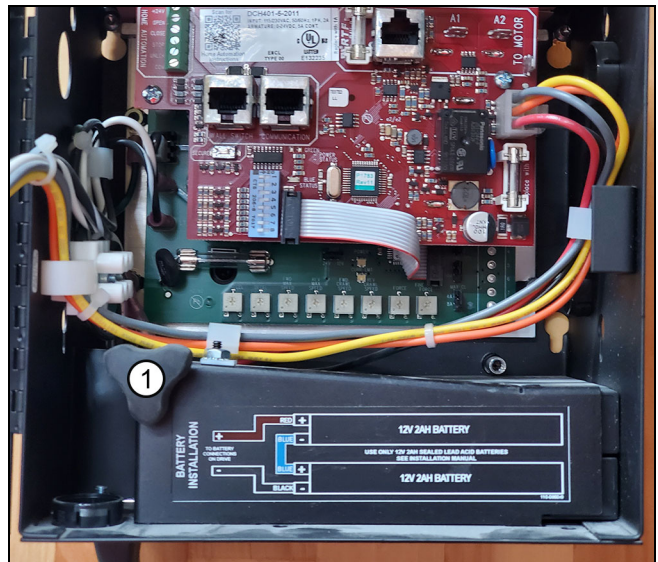

Figure 18

1	Battery cover nut
---	-------------------

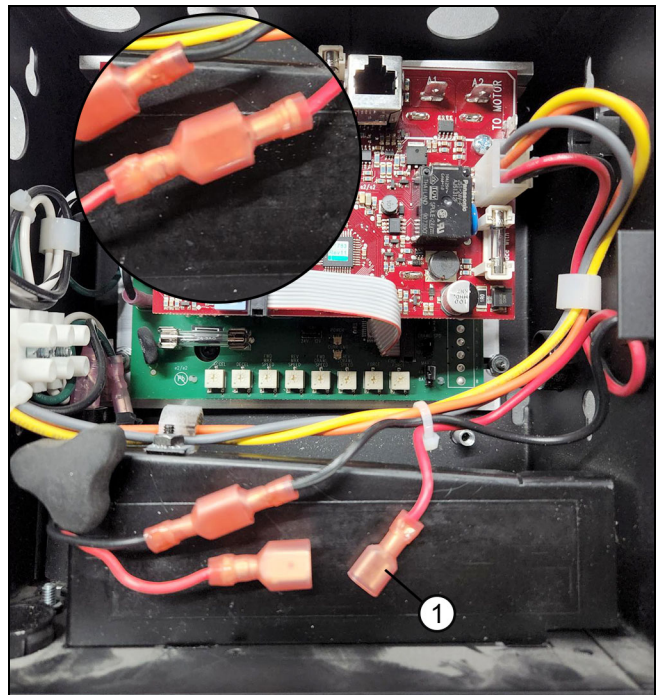

Figure 19

1	Battery cables.
---	-----------------



6. Insert the AC power cord into the bottom of the control box and plug the other end into a standard 110v/ 15 amp dedicated circuit.

## ATTENTION

The [next step](#) on hard wiring should only be done by a licensed electrician.

### Connecting Components

1. Attach the blue female cable crimp connectors to the 14-2 cable from the control box. [See Figure 20.](#)

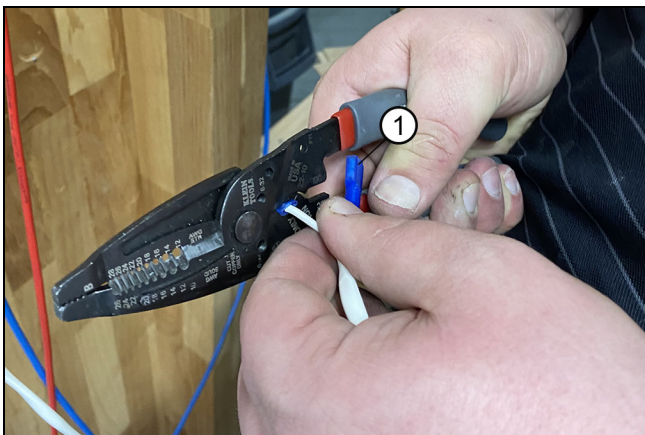

Figure 20

2. **Control Box to Motor:** the red Super Cable connects to the corresponding port on the motor. Red and black female leads from the motor to the black and white male leads from the control box. [See Figure 21.](#)

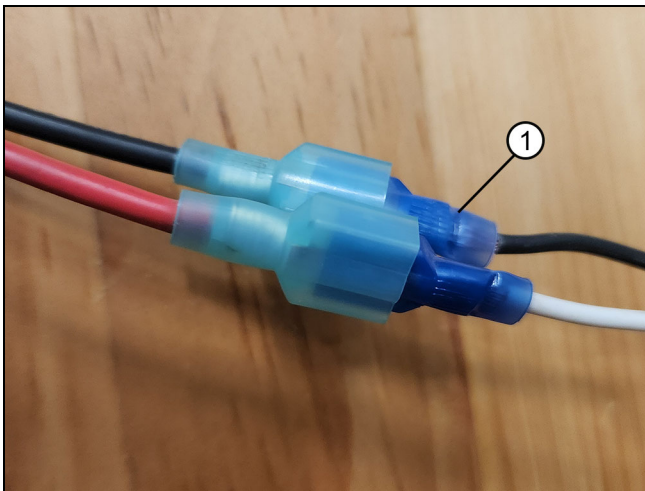

Figure 21

1	Ensure a solid crimp
---	----------------------

7. **Optional Hardwire:** Remove the two screws from the power port on the control box to access internal wiring.

3. **Wall Switches:** Connect the blue CAT5e from the "out" port on the wall switch to the corresponding wall switch port on the motor or control box. Additional wall switches can be added to the "in" port on the wall switch (daisy chain).

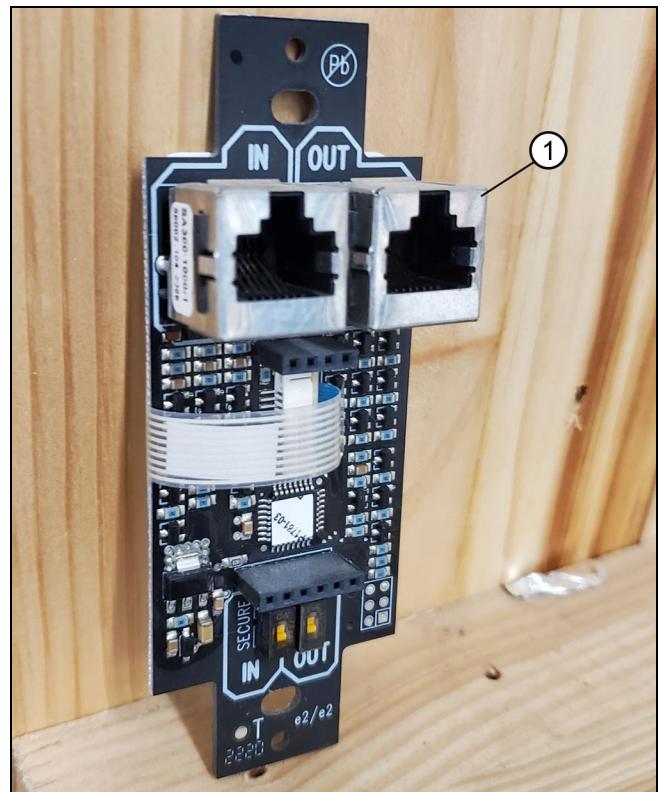

Figure 22

1	Wall switch "out" port.
---	-------------------------

4. **Sensors:** connect the yellow CAT5e to the corresponding sensor port on the motor. See [Figure 22](#) and [Figure 23](#).

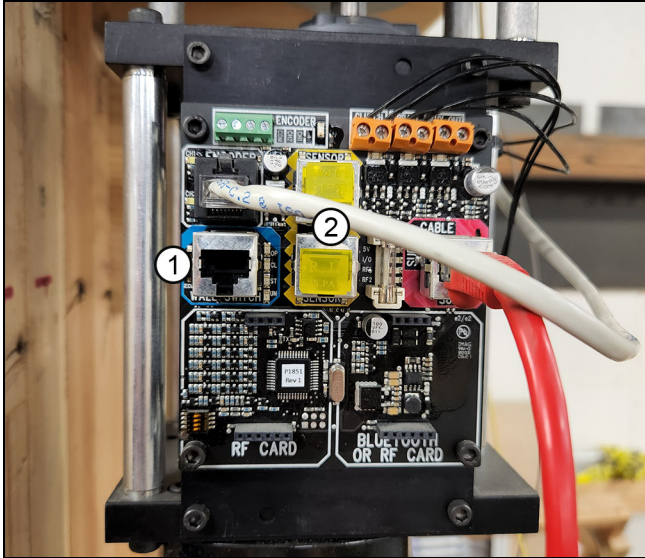

Figure 23

1	Wall switch port on the motor
2	Sensor ports on the motor

5. Use double sided tape to attach to the sensor to the head jamb cover. The sensor eye will fit through the hole in the cover. See [Figure 24](#).



Figure 24 Inset shows sensor eye through head jamb cover

1	Sensor through head jamb cover
---	--------------------------------



## Modern Multi-Slide Door Connections

1. Connect the "Wall Switch" port on the motor and the "Motor" port on the Marvin Control Module with the 2 ft. Cat5E cable.

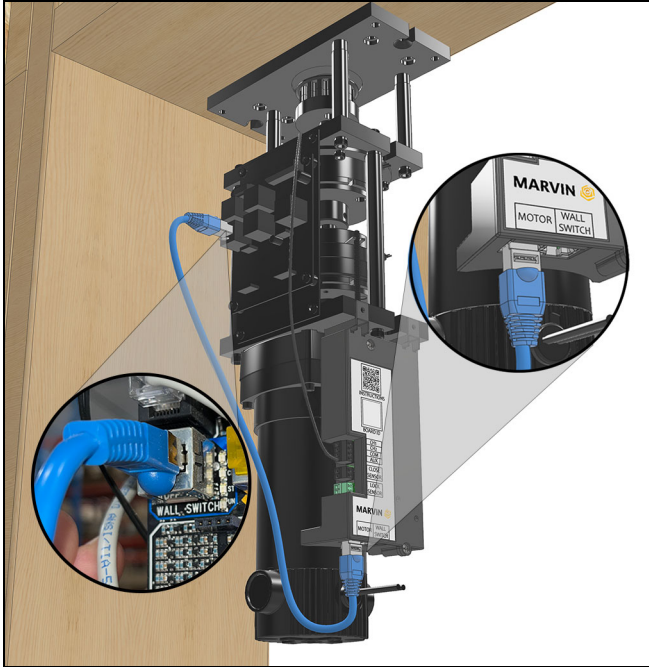

Figure 25

2. Connect the wall switch to the "Wall Switch" port on the module and NOT the motor. Optionally, an additional port is available in the control box.

*NOTE: The Modern Multi-Slide door uses a power transfer device (PTD) on the panel and in the frame. The PTD on the panel is installed at the factory. Take caution not to bend the springs when installing the panel.*

3. Install the frame PTD in the head jamb prior to panel installation. First, label your wire bundles. Label the reed switch bundle as "closed". Label the leaf spring bundle as "lock".

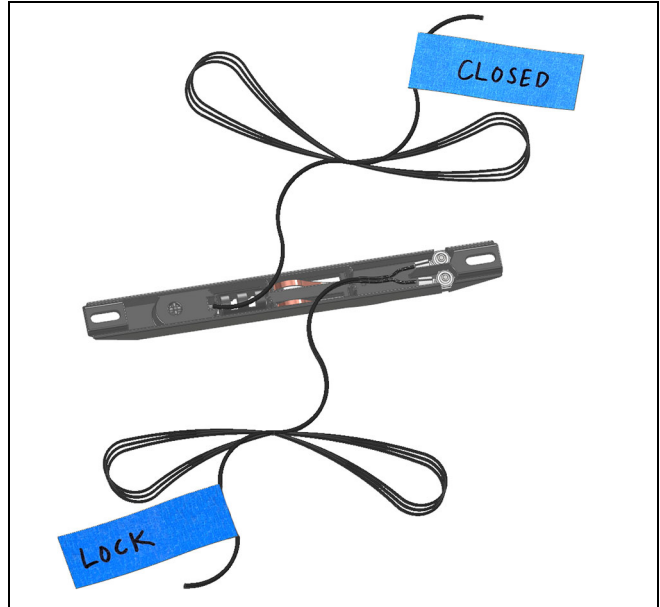

Figure 26 Label the reed switch and leaf spring wire bundles.

### ATTENTION

Run PTD wires through the frame fabrication and into the RO prior to completing the installation (before any insulation is applied).

4. If necessary (as in bi-parting configurations) splice the **un-stripped** wires with the connectors included and re-label the ends as "Closed" and "Lock".

## IMPORTANT

Do not strip the wires when using the connectors. If the wires are stripped, trim the exposed wire back. The orange button on the connector must be flush to the housing when compressed.

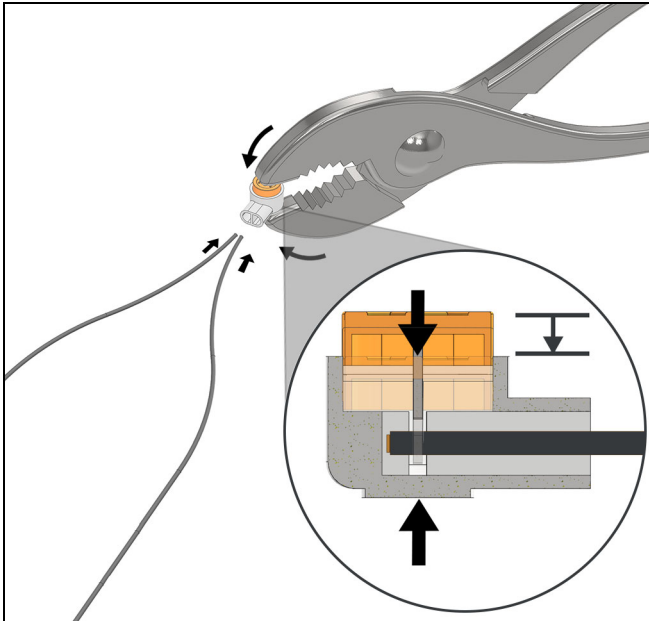

Figure 27

5. Shim the frame at the frame PTD location take care not to bow the head jamb.

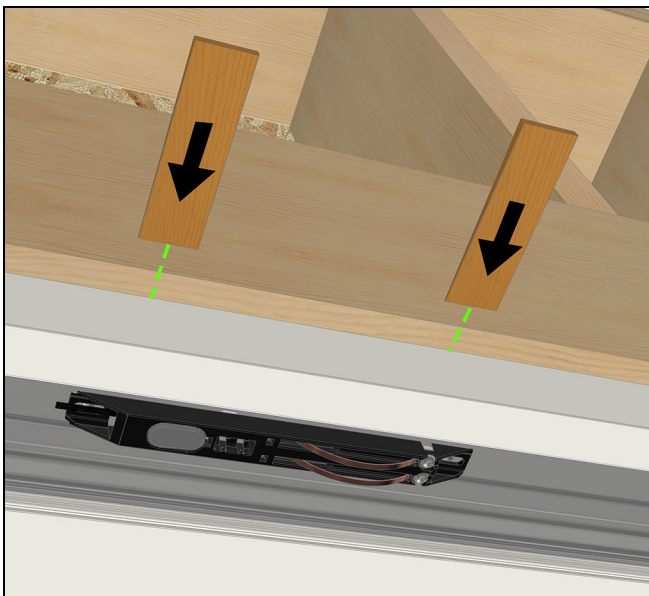

Figure 28

6. Install the frame PTD with #10 x 3" screws provided. Center the screws in the slots to position the PTD initially. When the PTD is positioned where you want it, drive the screws into the RO framing. **DO NOT OVERTIGHTEN SCREWS**

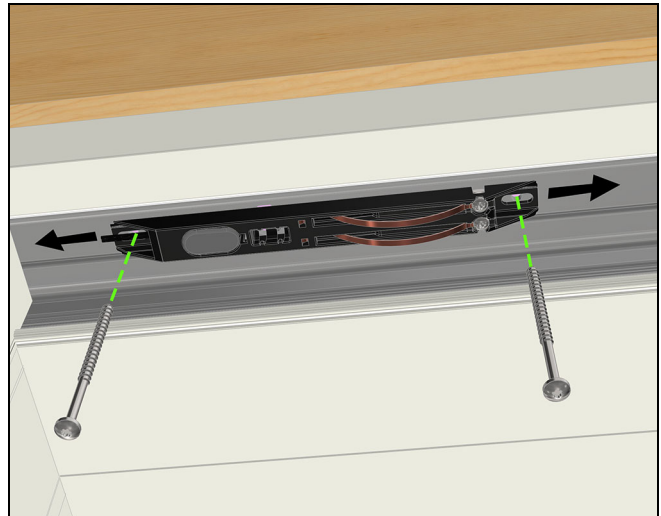

Figure 29

*NOTE: If adjustment is needed after installation, loosen the screws and slide the PTD left/right then tighten.*

7. Remove the black 2 pin connector marked "Close Sensor" and the green 2 pin connector marked "Lock Sensor" from the control module.

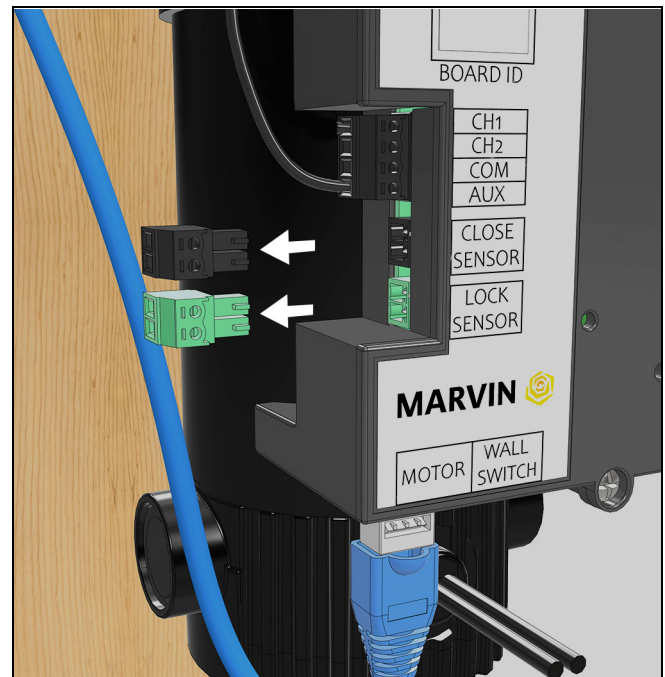

Figure 30

8. Connect the "closed" wire to the to the screw terminal on the black "Close Sensor". Connect the "locked" wire to the screw terminal on the green 2 pin connector marked "Lock Sensor". Re-install the black and green 2 pin connectors on the control module.

If you are on-boarding the unit to your Wi-fi network, refer to the [User and Troubleshooting Guide](#).

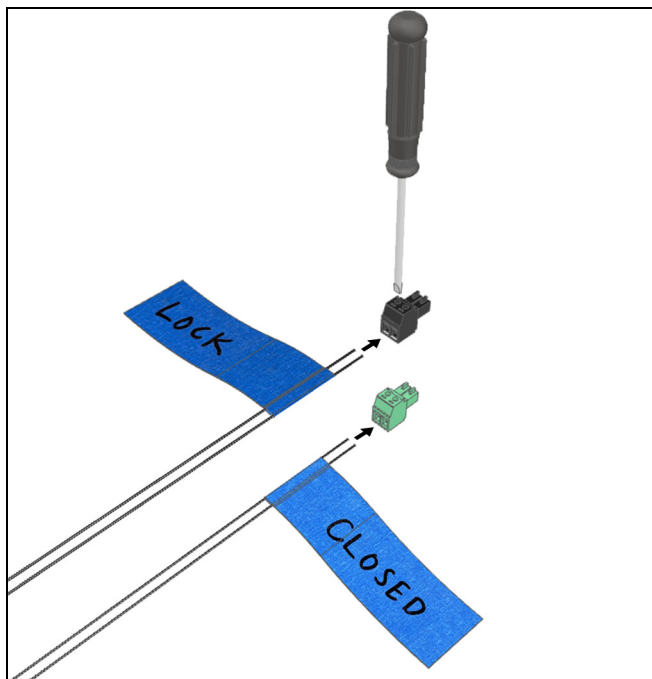

Figure 31



## Threading the Belt

### IMPORTANT

Ensure there are no twists in the belt throughout installation.

1. Loosen turnbuckle until there are 5 threads of engagement on each side. [See Figure 32](#)

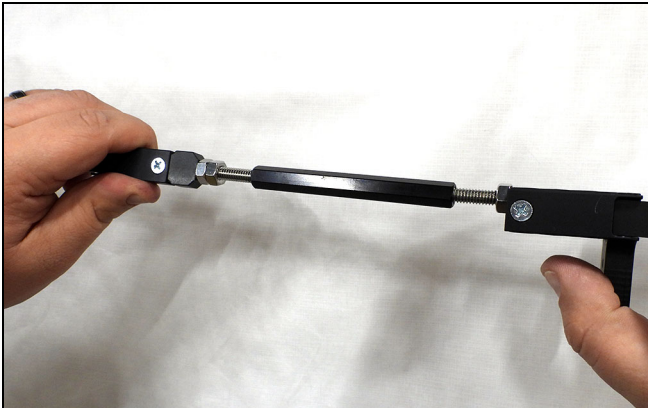

Figure 32

2. Insert belt through belt clamp. [See Figure 33](#)



Figure 33

3. Attach belt on panel bracket and fasten with #8- 32 x 3/8" screw. [See Figure 34](#), [Figure 35](#), and [Figure 36](#).

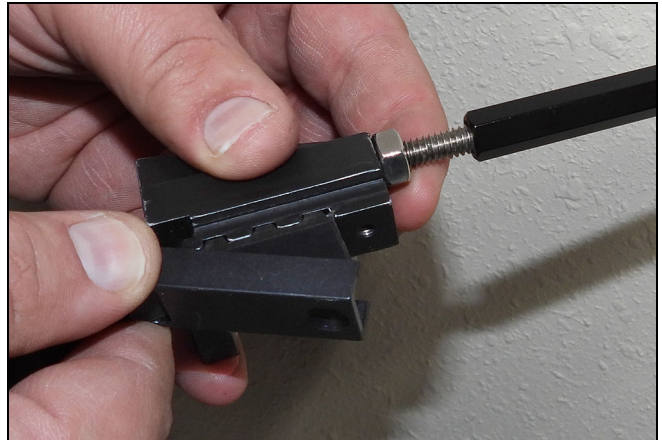

Figure 34

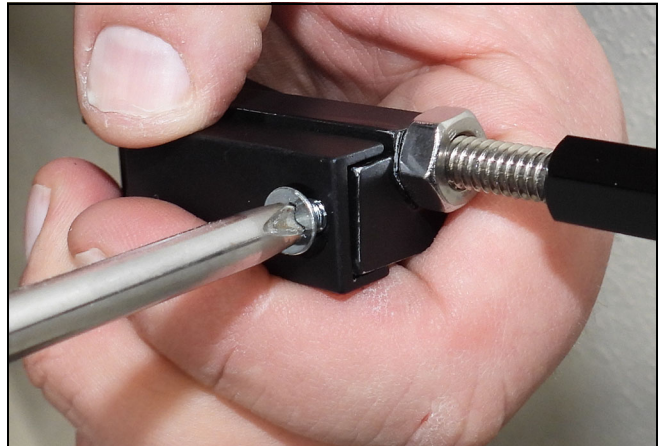

Figure 35

4. Thread belt through exterior side of return pulley. Ensuring no twists in belt, thread belt over top of panel with teeth facing up. [See Figure 36](#)



Figure 36



## IMPORTANT

On bi-parting units, belt must run above the structural bracket with teeth facing up. [See Figure 37.](#)



**Figure 37**

1	Structural bracket
---	--------------------

**5.** Thread the belt through the pass through corner key and around motor drive sprocket. Continue to thread the belt back over the panel tooth side up. [See Figure 38](#)



Ensure that termination of the belt is on the exterior side of the door.

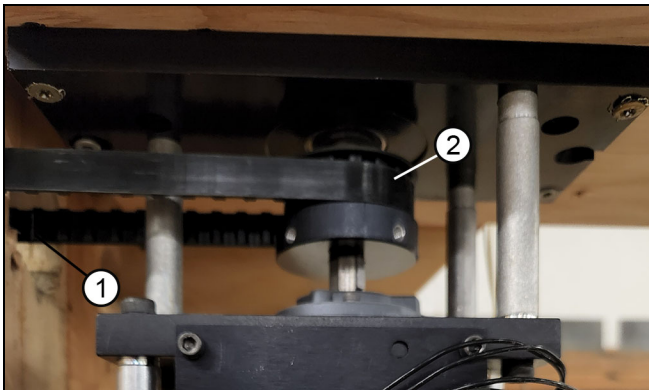

**Figure 38**

1	Holes in stud to access corner key
2	Belt

**6.** Pull the belt tight against the turnbuckle. Mark the belt to ensure there are 3 teeth of engagement on the turnbuckle. Cut the belt with a heavy shear. [See Figure 39.](#)

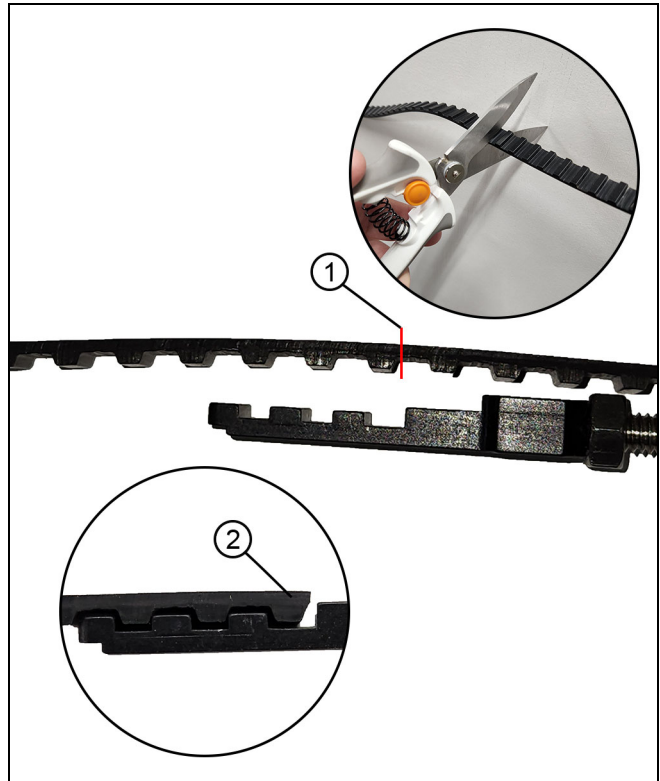

**Figure 39**

1	Cut next to the "tooth"
2	End tooth is fully engaged with clamp

7. Fasten belt to turnbuckle, completing the loop. See Figure 40.

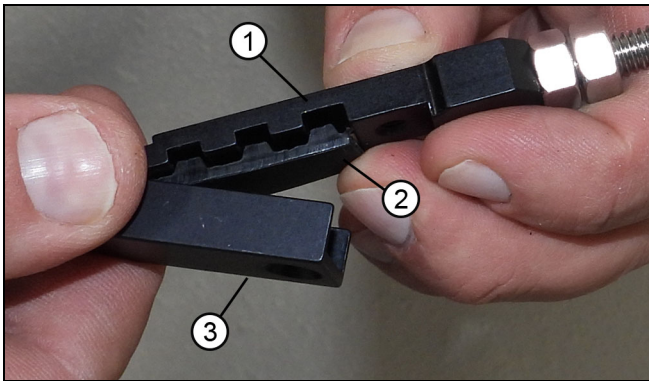

Figure 40

1	Turnbuckle
2	Belt
3	Clip

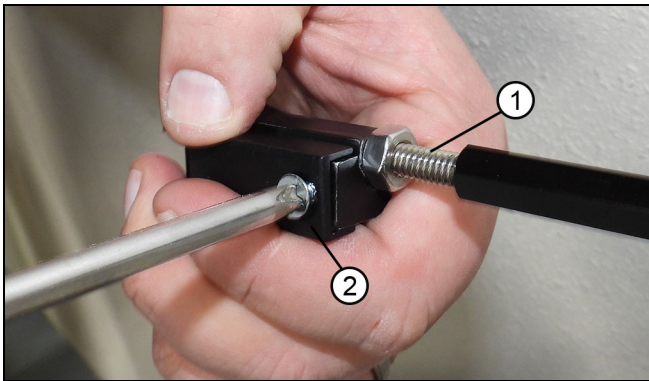

Figure 41

1	Turnbuckle
2	Set screws

8. Tighten turnbuckle nut until belt is taut, ensuring turnbuckle ends don't spin (twisting belt).

9. Tighten the lock nut against the turnbuckle barrel. See Figure 42.

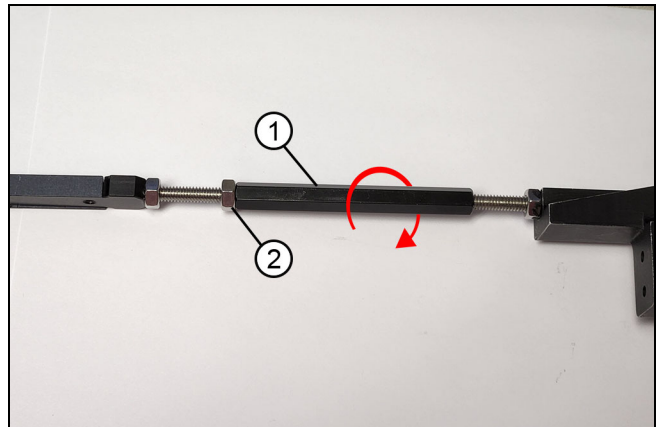

Figure 42

1	Barrel
2	Lock nut

10. Fasten the turnbuckle to the pulley side of the panel with two screws. See [Figure 43](#)



Figure 43

*NOTE: Follow the [next step](#) and [step 12 on page 19](#) for Bi-Parting units only.*

11. Hook the bi-parting clamp on the interior side of the belt with the teeth facing upwards. See [Figure 44](#)



Figure 44

12. With panels in locked position, slide the clamp into the route and fasten with two screws. Ensure the clamp is engaged with the teeth on the belt. See [Figure 45](#)



Figure 45

## Installing the Optional Closing Ramp

Using a smartphone or similar device, scan the QR code or click [here](#) to play a video of this procedure.



**NOTE:** the closing ramp is mounted to the frame, and helps apply force to the back side of the panel to ensure the panel fully seats into the jamb. It is typically needed on narrow and tall panels.

1. Fully close the door.
2. Locate the pre-drilled hole 1" behind the interlocking stile. [See Figure 46.](#)

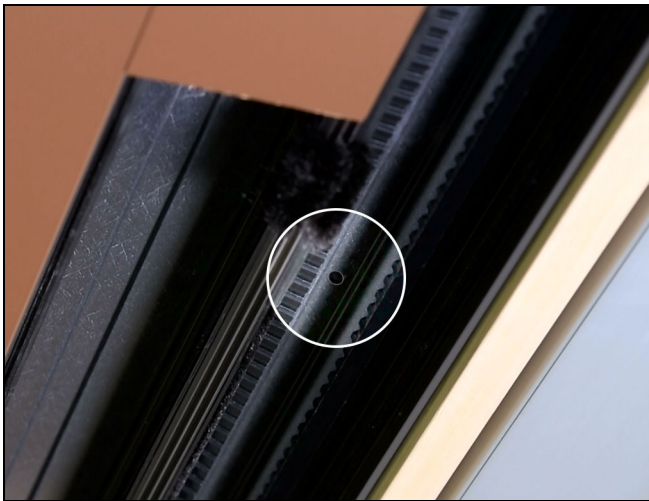

Figure 46

3. Open the primary panel(s) past 1 full panel width.

**NOTE:** If you have an OX, XO, or OX-XO unit, leave the panel(s) fully closed.

4. Install the closing ramp, using the provided #8 x 3" screw, into the pre-drilled hole.
5. Close and lock the door.
6. Pull the ramp tight so that it fully contacts the turnbuckle. [See Figure 47.](#)

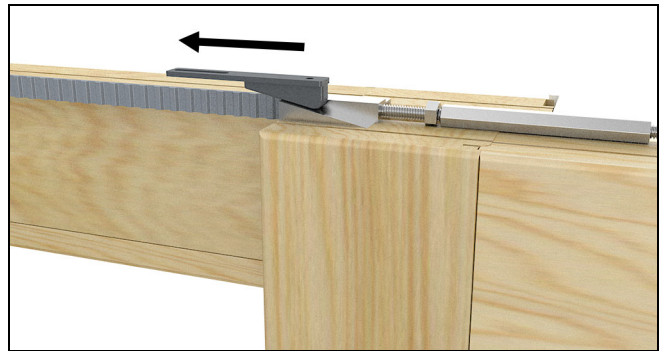

Figure 47

**NOTE:** If more contact is needed, adjust the set screw in the closing ramp.

7. Open and close the door using Sliding Door Automatic Control System. Ensure the door manually locks. If the door doesn't manually lock, adjust the set screw. [See Figure 48.](#)

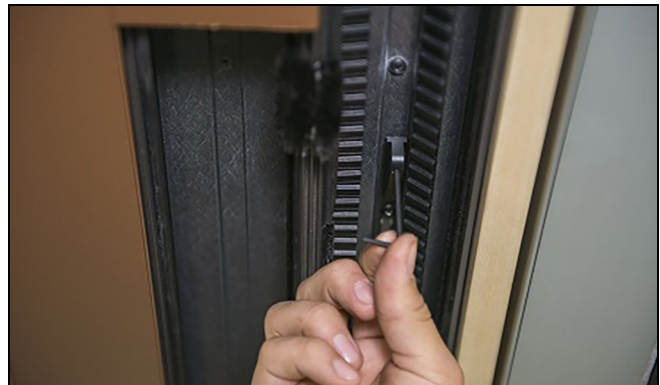

Figure 48



---

## Optional Belt Clips

1. On large units, the belt clips can be installed to eliminate belt sag. Use the belt clip to hold the belt **(opposite of the turnbuckle or bi-parting bracket)** with teeth up against the head track. Fasten the belt clip in the head track with the screws provided. Pre-drilling may be necessary. [See Figure 49.](#)

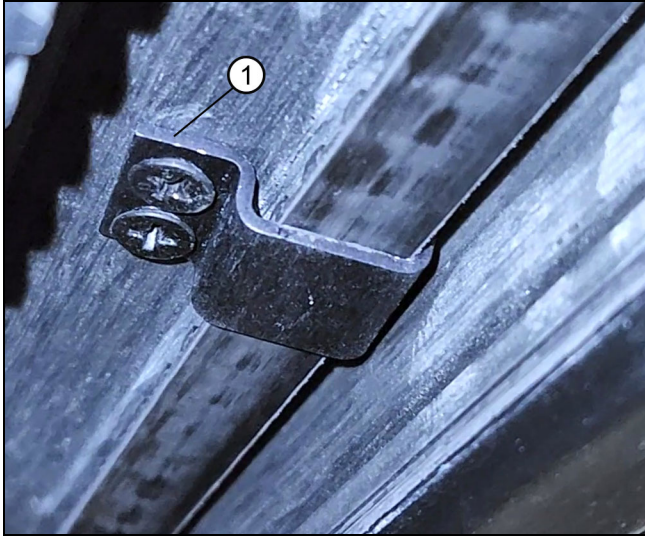

Figure 49

1	Belt clip
---	-----------

## Programming

*NOTE: Summit will provide documentation on how to properly program the system.*

- 1. Initial Programming:** make sure both AC and DC power to the system are turned off on the control box cover. Place the lead panels to the halfway point of the opening. Then turn on both AC and DC power.
2. Press the "OPEN" button on the wall switch. The panel will start to move. If the door is moving to the open position, the polarity is correct. Let the panel move 24" and then press "UNLOCK" on the wall switch. The door will stop. [See Figure 50.](#)

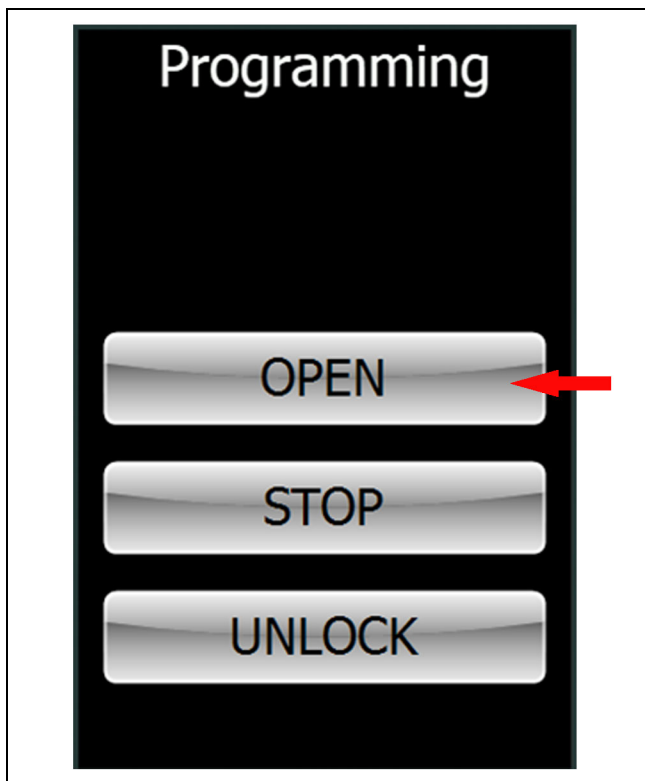

Figure 50

3. If the polarity is incorrect and the door is closing, press "OPEN" a second time and the door will change polarity. Let the panel travel approximately 24" before pressing "UNLOCK" and moving on to the next step.
4. Manually move the door to the fully open position. Press and hold the "UNLOCK" button until the touch screen shows "Release Button!" or red and blue lights blink rapidly (on non-touch screens). [See Figure 51.](#)

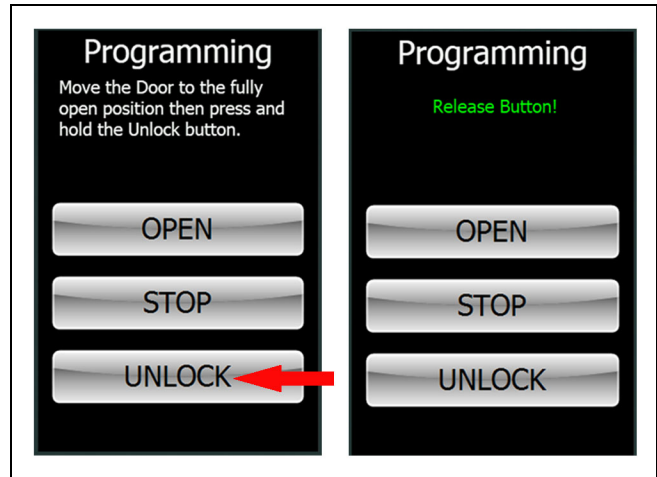

Figure 51

5. Move the door manually to the fully closed position. Press and hold the "UNLOCK" button until the touch screen shows "Release Button!" or red and blue lights blink rapidly (on non-touch screens). [See Figure 52.](#)

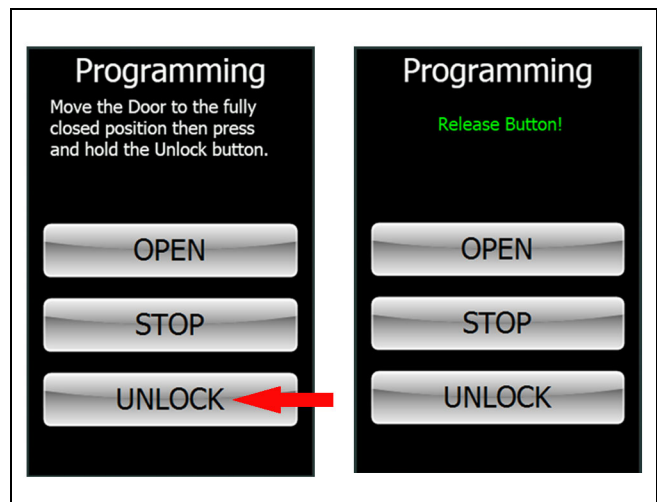

Figure 52

6. Once the "UNLOCK" button is released, the door will automatically cycle in programming mode.

### **WARNING!**

The automatic stop feature is disabled in programming mode. Make sure the opening is kept clear when programming.

7. Once the door stops and is engaged in the closed position, the programming is complete.

## Reprogramming

In the event that you replace a panel, experiencing problems with door motorization, run these steps to re-program/reset.

1. With both AC and Battery power off on the control box cover, place the lead panel to the halfway point of the opening.
2. Open the control box and flip dip switch 8 to the right. See [Figure 53](#).

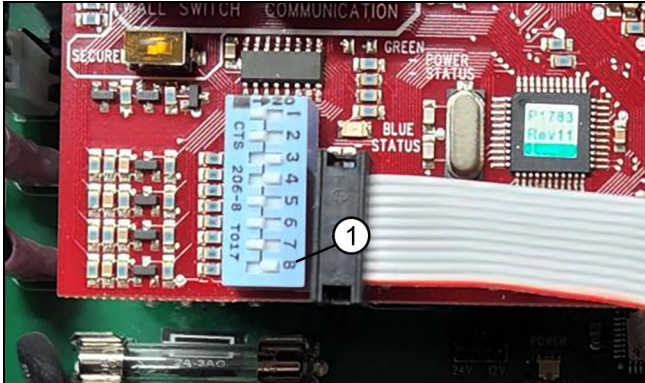

Figure 53

1	Dipswitch 8
---	-------------

3. Turn on both AC and Battery power switches on the control box cover. Open the control box and flip dip switch 8 back to the left. See [Figure 54](#).

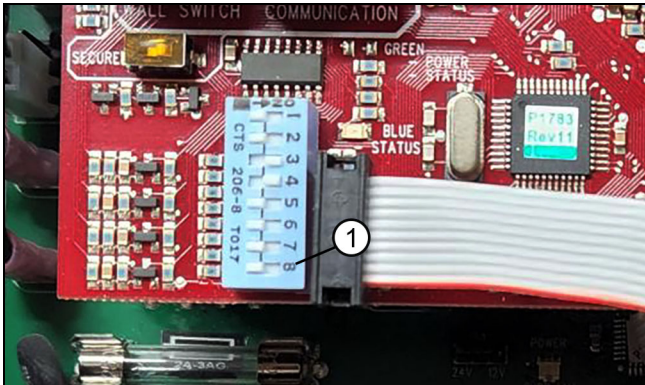

Figure 54

1	Dipswitch 8
---	-------------

4. Refer to [Programming on page 22](#).