

# Ultimate Wood Bi-Fold Door Installation Instruction

## After Market Products

Alterations to Marvin products including window films, insulating or reflective interior window treatments or additional glazings can cause excessive heat buildup and/or condensation. They may lead to premature failures not covered under warranty by Marvin Windows and Doors.

Before purchasing or applying any product that may affect the installation or performance of Marvin windows contact the manufacturer of after market product/glazings that are not supplied by Marvin and request written product use, associated warranties and damage coverage. Provide this information and warranties to the end user and/or building owner for future reference.



### WARNING!

Always practice safety! Wear the appropriate eye, ear and hand protection, especially when working with power tools.



### WARNING!

Older homes may contain lead-based paint, which may be disturbed when replacing windows or performing renovations. Consult state or local authorities for safe handling, disposal, or abatement requirements. For more information, go to [www.epa.gov/lead](http://www.epa.gov/lead).



### WARNING!

This product can expose you to chemicals including methanol, which is known to the state of California to cause birth defects or other reproductive harm. This product can expose you to chemicals including titanium oxide, which is known to the state of California to cause cancer. For more information, go to [www.P65Warnings.ca.gov](http://www.P65Warnings.ca.gov).



### WARNING!

Drilling, sawing, sanding or machining wood products can expose you to wood dust, a substance known to the State of California to cause cancer. Avoid inhaling wood dust or use a dust mask or other safeguards for personal protection. For more information go to [www.P65Warnings.ca.gov/wood](http://www.P65Warnings.ca.gov/wood).

Note: Numbers listed in parentheses ( ) are metric equivalents in millimeters rounded to the nearest whole number

Note: All images are for illustrative purposes only.

Note: Please consult with local waste management authorities regarding proper disposal and/or recycling of all waste materials generated during installation, including any product being replaced, packaging materials, and other waste.

## You Will Need to Supply:

- Safety Glasses
- Hearing protection
- Level and/or laser
- Square
- Hammer
- Wood shims
- 2" Roofing nails
- Insulation
- Tape measure
- Perimeter sealant
- Sill pan flashing
- Backing material (foam backing rod)
- Low expansion foam insulation
- Flashing materials
- Weather resistive barrier
- Standard hex key set

## Frame Assembly

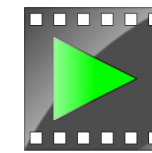

To watch a video on this step, click on the play button or scan the QR code with your smart phone or similar device.

NOTE: If unit is over 23 1/2', refer to splicing section prior to frame assembly.

NOTE: For floor channel sill, sill track must be installed into floor prior to frame installation.

NOTE: Floor channel sill length matches the Frame OM Width and should be aligned flush with rough opening side of both jambs.

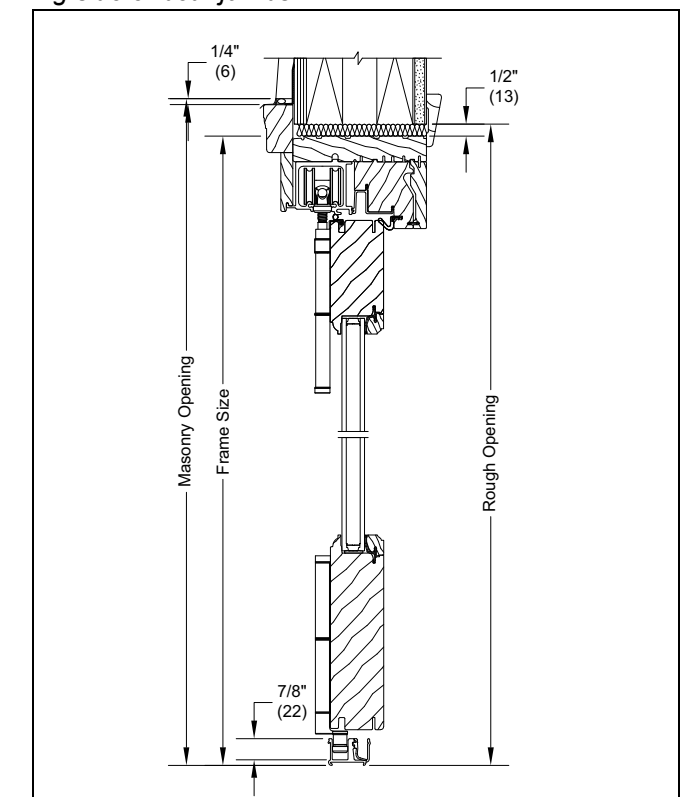

1. Fasten sill to jamb. See Figure 1.

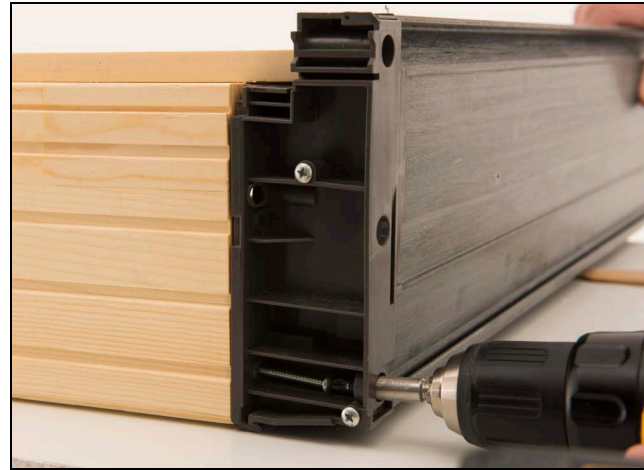

Figure 1

1	2 per side- #8 x 1 3/4" Pan head
---	----------------------------------

2. Fasten jamb to head jamb using three #7 x 2" screws. See Figure 2.



Figure 2

### BMC Application

1. Apply sealant to corner key. Bead must be large enough to contact BMC when applied. See Figure 3.

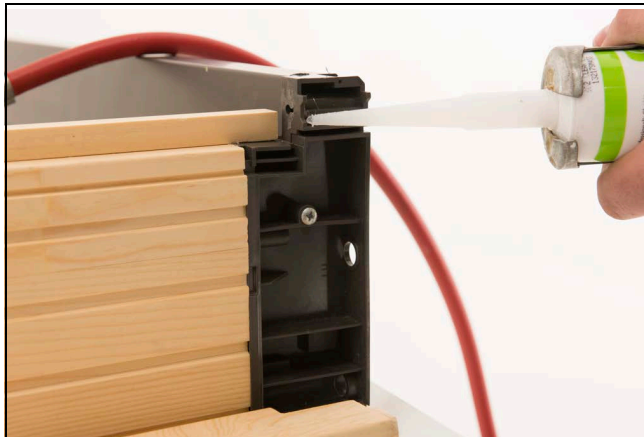

Figure 3

2. Starting at the sill, apply jamb BMC using 14 gauge 2" nails spaced 8-10" on center and within 2" of each end. See Figure 4.



Figure 4

3. For units with spliced casing at the header the casing is sent long. Trim casing to fit by cutting the splice at a 45 degree angle to allow the casing to overlap. See Figure 5.

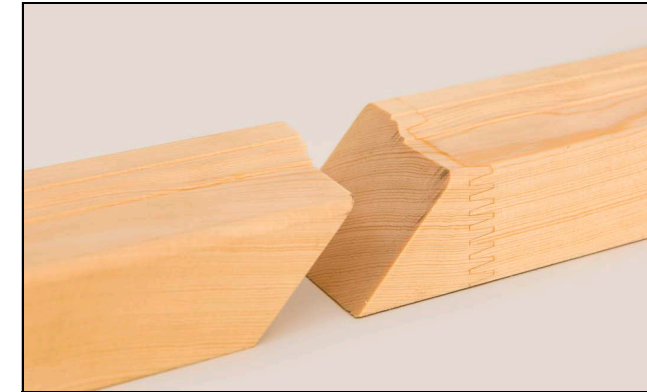

Figure 5

4. Apply head jamb BMC using 14 gauge 2" nails spaced 8-10" on center and within 2" of each end. See Figure 6.

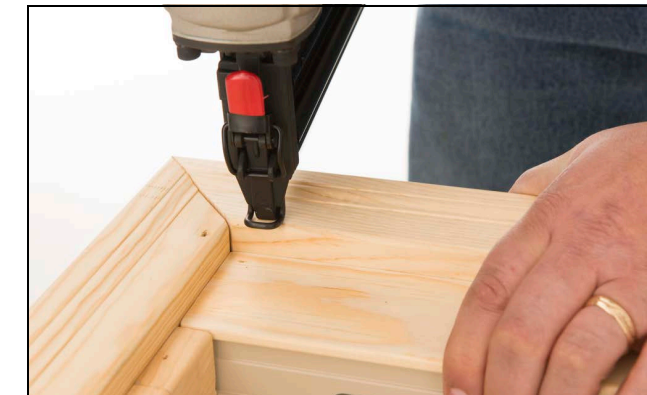

Figure 6

5. Secure corner with #7 x 2" screws. See Figure 7.



Figure 7

6. Back caulk the BMC to the frame joint with silicone sealant and apply sealant to the BMC joint. See Figure 8.



Figure 8

### Sill Splicing



To watch a video on this step, click on the play button or scan the QR code with your smart phone or similar device.

1. Lay out sill sections in correct order.

2. Fasten the sill splice bracket(s) into one side of the sill. See Figure 9.



Figure 9

3. Apply sealant along the highlighted section. See Figure 10.

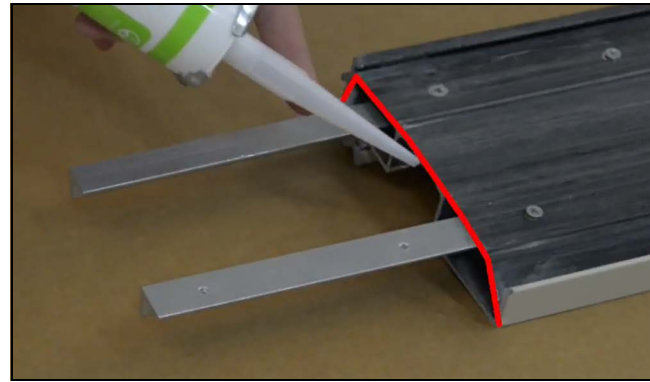

Figure 10

4. Align the sill sections and slide the parts together. See Figure 11.

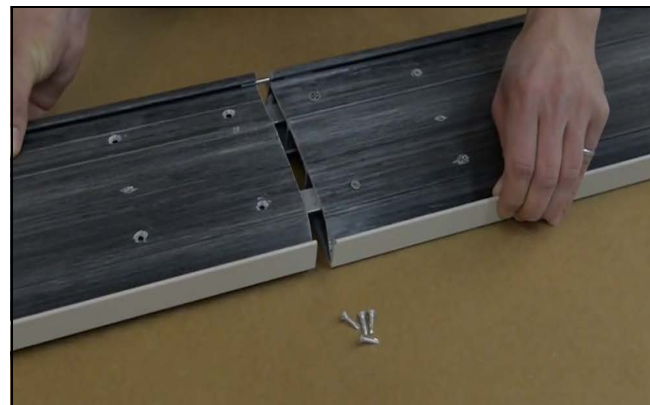

Figure 11

5. Fasten the other side of splice bracket using self drilling screws. See Figure 12.

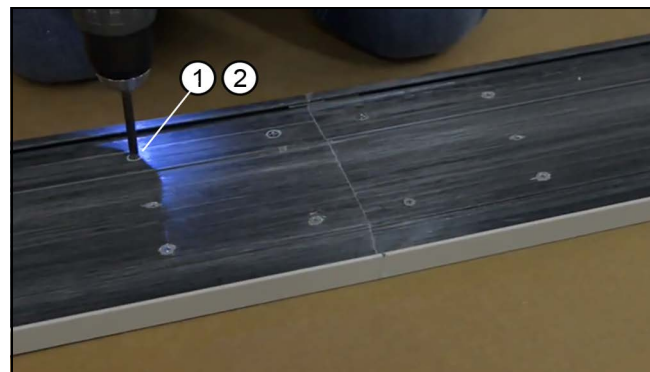

Figure 12

6. Apply sealant over all screws and remove excess sealant from sill. See Figure 13.

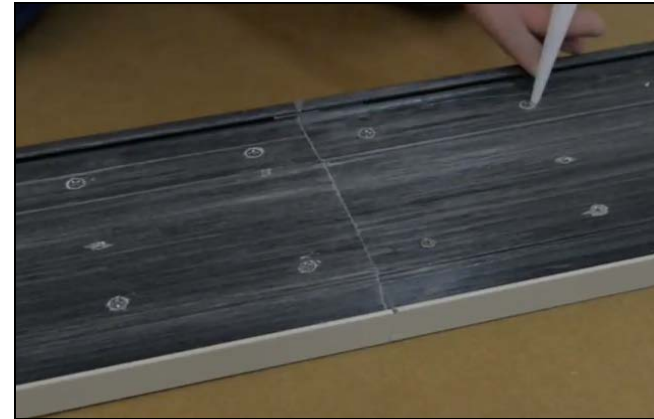

Figure 13

7. Insert weather strip 11/16" (17) from corner key on each side. See Figure 14.



Figure 14

## Frame Installation

**NOTE:** Before installation, ensure Rough Opening has been prepped according to the site prep guide.

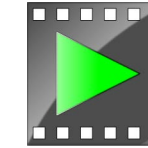

To watch a video on this step, click on the play button or scan the QR code with your smart phone or similar device.

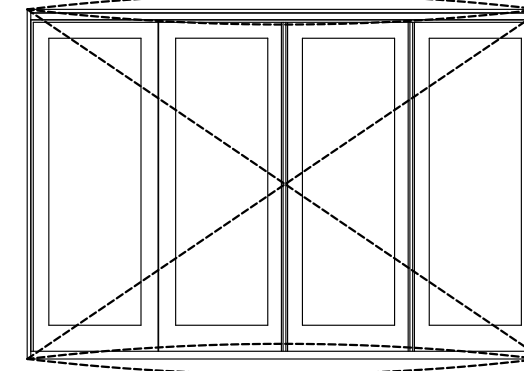

Frame tolerance

Head Jamb:  $-0" +1/16"$

Square:  $\pm 3/16"$

Sill:  $\pm 1/16"$

1. **IMPORTANT:** Sill screws must be sealed prior to installing. Fasten sill through all pre-drilled holes. See Figure 15.



Figure 15

1	#8 x 1 1/2" screws minimum supplied by others
---	---

2. Fasten jambs through all pre-drilled holes, shims should be placed at all fastening locations. See Figure 16.



Figure 16

1	#8 x 3" Flat head screws
---	--------------------------

3. Fasten head jamb track through all pre-drilled holes. See Figure 17 and Figure 18.



Figure 17



Figure 18

1	1/4" x 3 1/8" Washer head screw
---	---------------------------------

4. Remove shipping screws and pre-drill 1/4" through all shipping holes. See Figure 19 and Figure 20.



Figure 19



Figure 20

5. Fasten head jamb support block through all pre-drilled holes. See Figure 21.



Figure 21

1	#8 x 3 1/2" Flat head screws
---	------------------------------

6. Snap in sill insert. See Figure 22, Figure 23, and Figure 24.



Figure 22

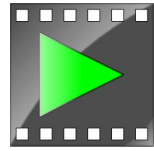

Figure 23

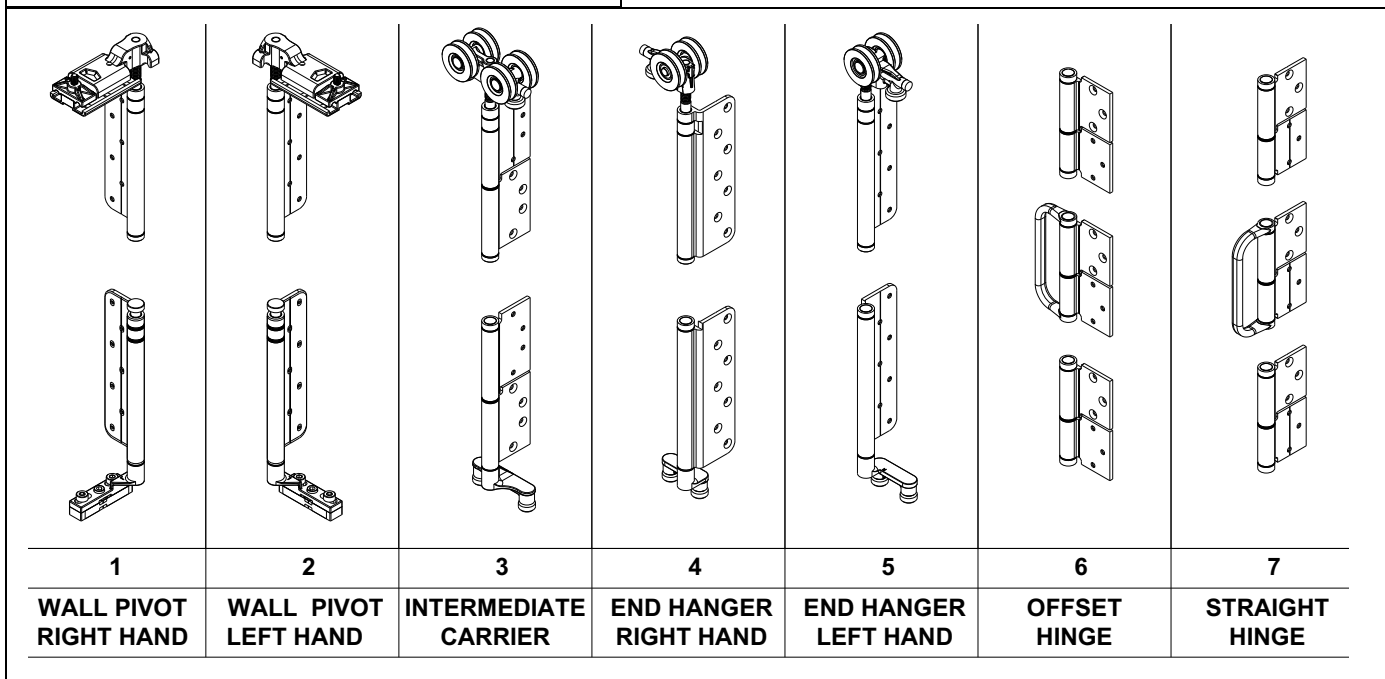

Figure 24

## Hinge Installation



To watch a video on this step, click on the play button or scan the QR code with your smart phone or similar device.



For information on configuration and hinge placement, please refer to enclosed diagram. See Figure 25.

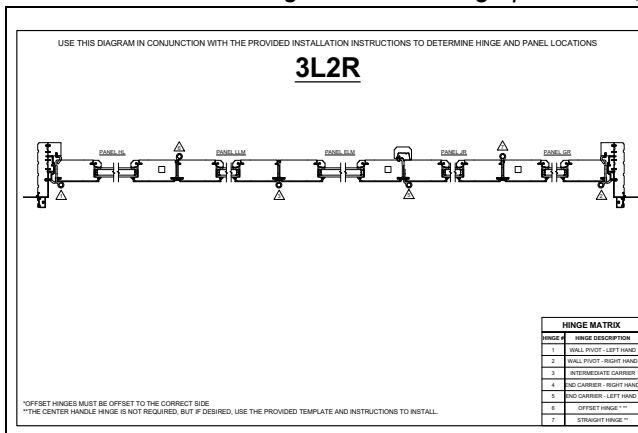

Figure 25

1. Place any top roller hinges numbered 3-5 in head track in the correct order using configuration diagram as guide for your configuration. See Figure 26.



Figure 26

**IMPORTANT:** Ensure small cam doesn't fall out during step 2.

2. Install top portion of any hinges 1 and 2 in correct end of head track by loosening the two outer bolts but not removing them. See Figure 27 and Figure 28.

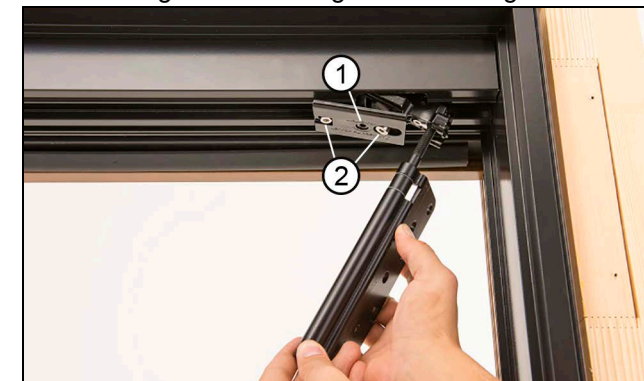

Figure 27

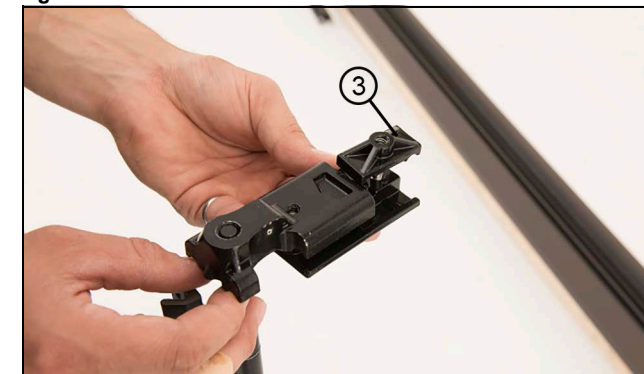

Figure 28

1	Adjustment cam
2	Outer hex bolts
3	Track clamp position

3. Rotate clamp and tighten bolt furthest from the jamb. See Figure 29 and Figure 30.

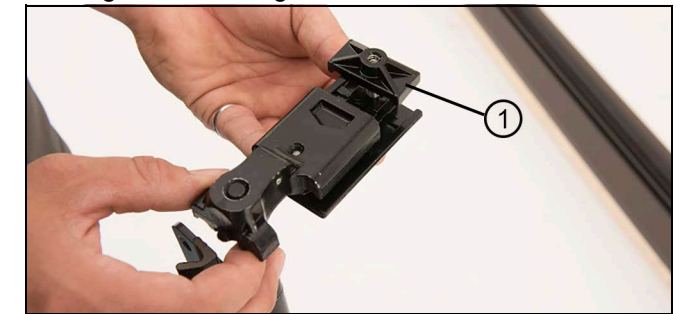

Figure 29

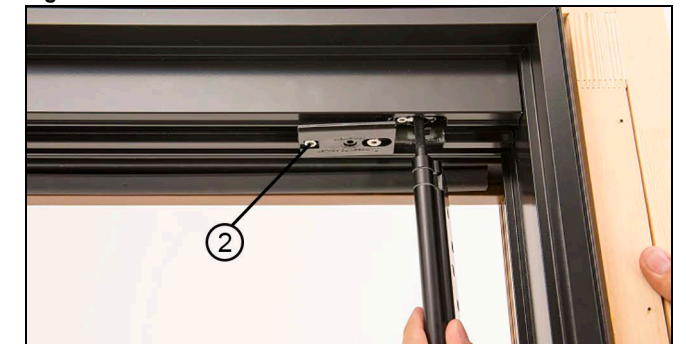

Figure 30

1	Track clamp position
2	Position and tighten this bolt

4. Slightly tighten the bolt closest to jamb.

5. Place hinge in the middle of its adjustment range by rotating center cam, then fully tighten the bolt closest to jamb. See Figure 31.



Figure 31

6. Install bottom portion of hinges 1 and 2 in correct end of sill ensuring shim is installed below it. See Figure 32 and Figure 33.

*Note: On low profile and floor channel sills, the screws will stick slightly proud of the bottom of the sill.*

Note: Hinge must be adjusted out to allow screws to go in.

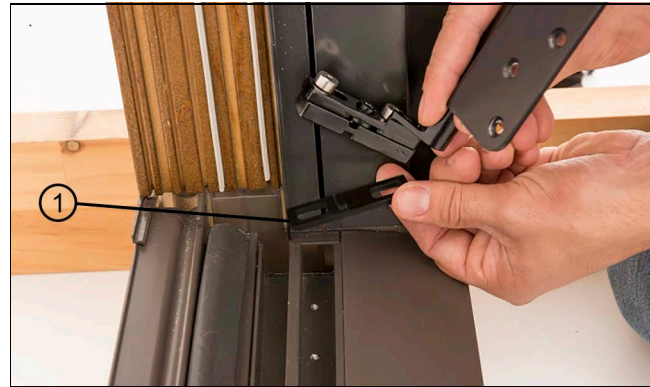

Figure 32

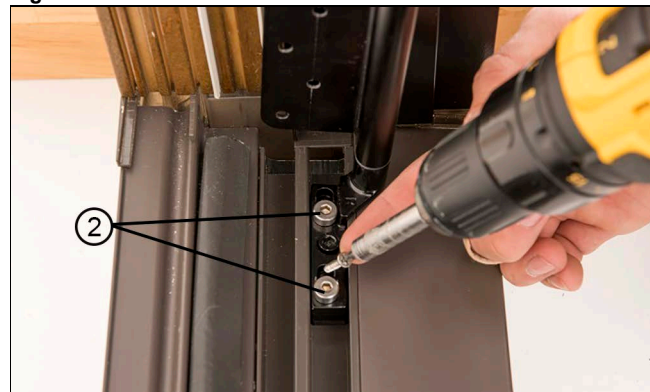

Figure 33

1	Floor shim
2	#7x 3/4" Flat head

7. Place hinge in the middle of its adjustment range by rotating center cam, then fully tighten the bolt. See Figure 34.



Figure 34

3. **Bottom Wall Pivot:** Loosen both 5/32" hex bolts slightly. See Figure 37.



Figure 37

4. Turn the center adjustment cam with a 3/16" hex wrench to adjust side to side. Tighten the hex bolts that were loosened in step one. See Figure 38.



Figure 38

5. Up and down adjustment can only be done on the top hangers. Turn and hold the height adjustment lock at the base of the hinge with a 1/8" hex wrench. Use a 3/16" hex wrench in the end of the hinge to adjust the height. Turning Clockwise will raise the panel, while turning counter clockwise lower the panel. See Figure 39.



Figure 39

## Hanger and Wall Pivot Adjustments

1. Side to side adjustments can only be done on the wall pivot and end pivot. **Top Wall Pivot:** Loosen the hex bolt nearest to the jamb with a 5/32" hex wrench. See Figure 35.



Figure 35

2. Turn the center adjustment cam with a 3/16" hex wrench to adjust the panel side to side. Tighten the hex bolt that was loosened. See Figure 36.

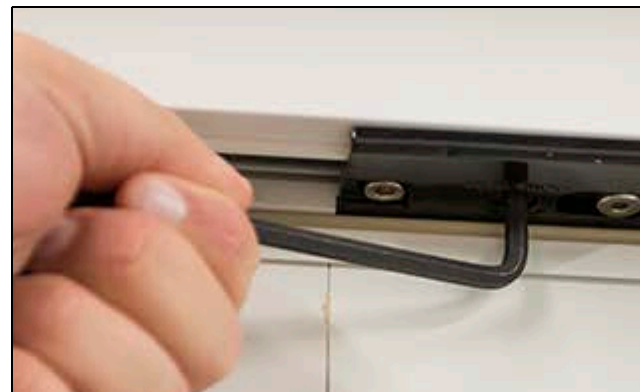

Figure 36

## Panel Installation



To watch a video on this step, click on the play button or scan the QR code with your smart phone or similar device.

**NOTE:** Panels are lettered according to configuration. Refer to enclosed diagram for panel configuration. See Figure 40.

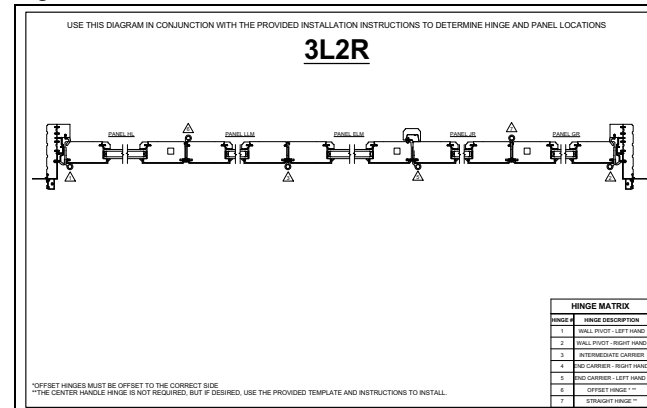

Figure 40

**1. Important:** Locate any panels with the letter "M" on the end. (Example ELM). Install magnetic catch base to top and bottom panels prior to installing panels. Position magnet pads into aluminum covers, then fasten each to

the base. See Figure 41 and Figure 42.

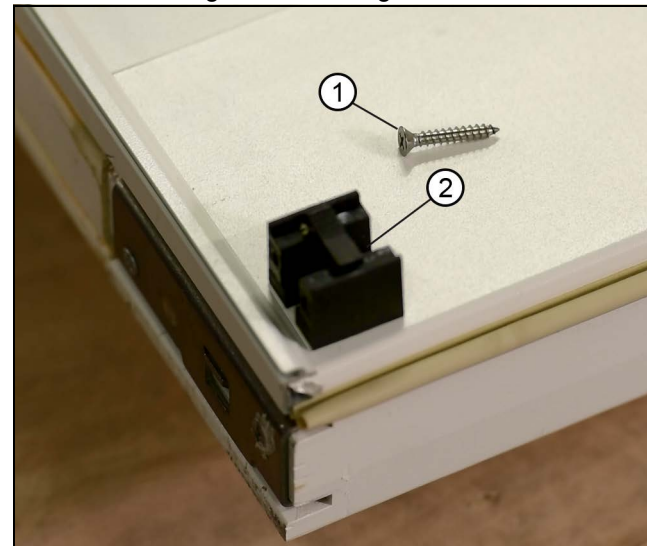

Figure 41

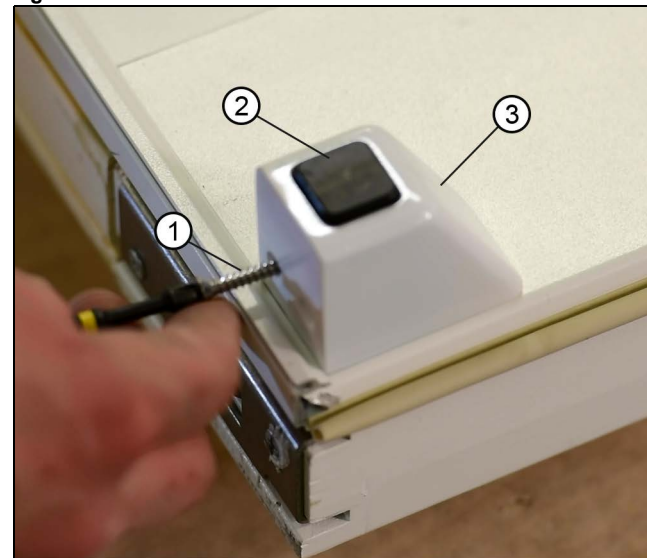

Figure 42

1	#8 x 1" Flat head screws
---	--------------------------

**2.** Locate panels adjacent to any hinges numbered 1 and 2 and fasten. See Figure 43 and Figure 44.



Figure 43

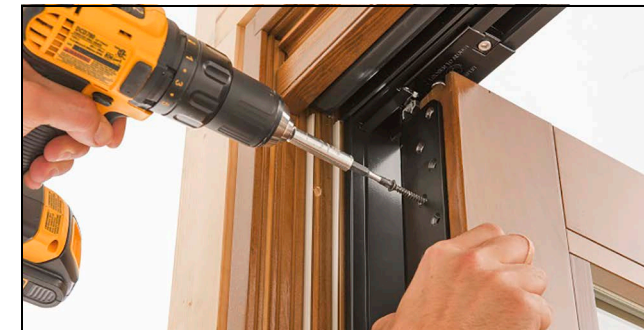

Figure 44

1	#10 x 2" Flat head screws
---	---------------------------

**3.** Depending on configuration, install next panel(s) using configuration diagram as guide. For interior hinges 6 or 7, use two shorter screws on hinge leaf attached to panel with the locking handle. See Figure 45. Use the #10 x 2" Flat head screw in offset hole on the hinge leaf. Installing the long screw in the other hole will interfere with the panel handle operation.

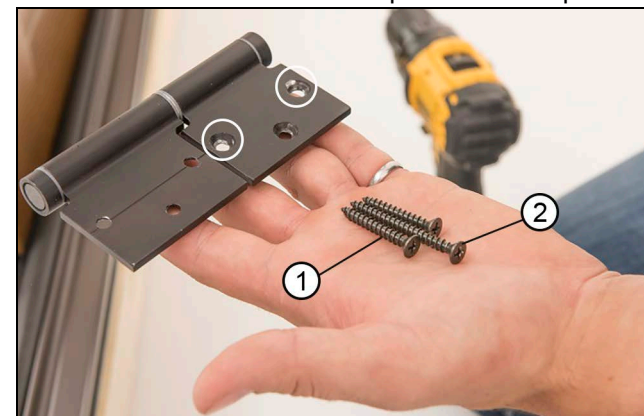

Figure 45

1	#10 x 1 1/4" Flat head
---	------------------------

**4.** Attach intermediate and end hangers (hinges 3, 4, 5), if applicable to your configuration. See Figure 46 and Figure 47.



Figure 46

1	#10 x 1 1/4" Flat head
---	------------------------



Figure 47

## Hinge/Handle Optional Installation

1. Open the panels to 90 degrees. Pre-drill the holes with template provided with the handle kit. See Figure 48.



Figure 48

2. Line up the handle with the pre-drilled holes. Attach the handle with the provided screws. See Figure 49.



Figure 49

3. Open hinge across to the second panel and pre-drill through the hinge. Ensure the panel gap is set using the provided template before drilling. Attach the handle with provided screws. See Figure 50.



Figure 50

4. Slice the flexible portion of the weather strip above and below the installed handle. See Figure 51 and Figure 52.

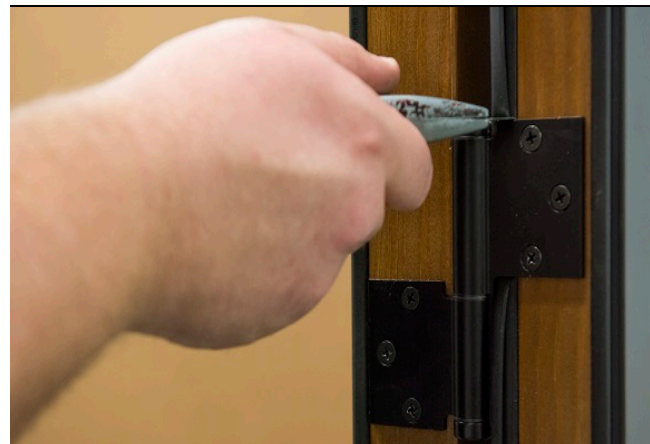

Figure 51

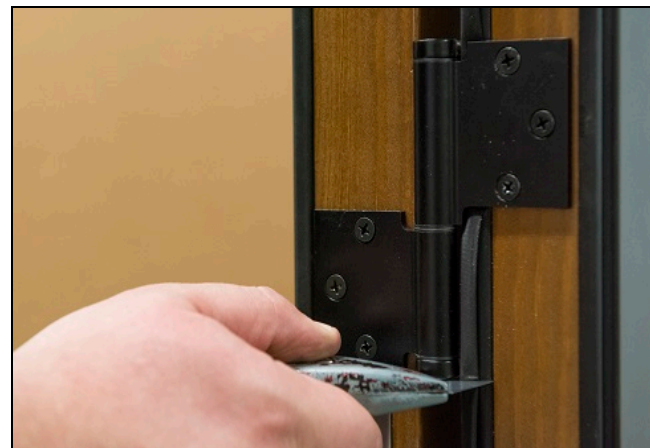
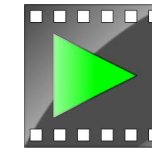

Figure 52

## Final Installation



To watch a video on this step, click on the play button or scan the QR code with your smart phone or similar device.

1. Measure the gap between the panel and jamb. Choose proper height support block. See Figure 53 and Figure 54.



Figure 53

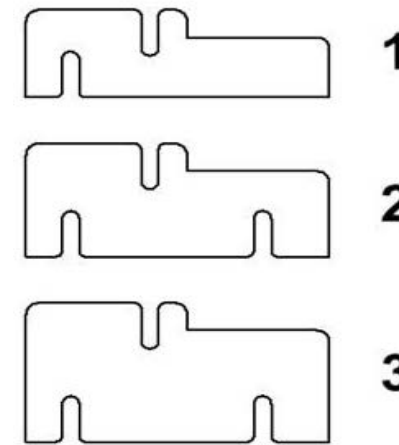

Figure 54

1	<3/4"
2	3/4" - 7/8"
3	>7/8"

2. Install support blocks. See Figure 55.

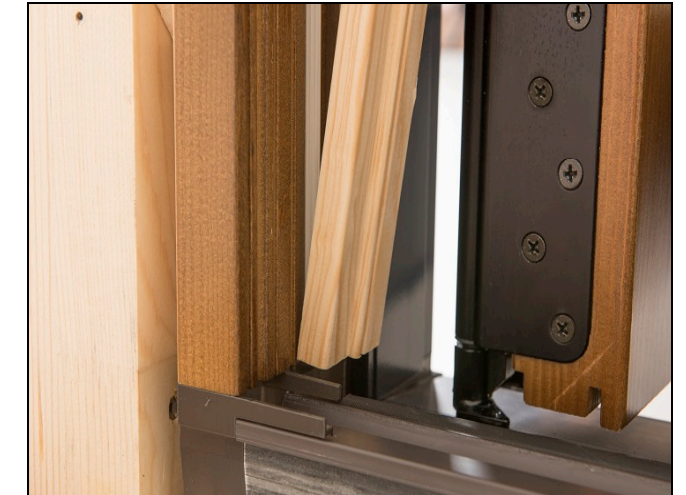

Figure 55

3. Pull weather strip back approximately 12" at sill and head jamb. See Figure 56 and Figure 57.



Figure 56





Figure 57

4. Install frame cover. *Note: If locking jamb, install frame cover with pre-punched hole for strike.* See Figure 58.

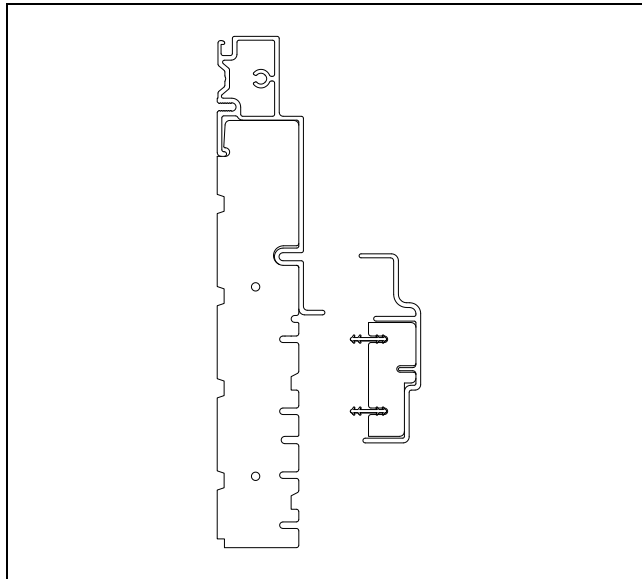

Figure 58

5. Install head jamb part stop. See Figure 59.



Figure 59

6. Install wood jamb part stops ensuring longer side of weather strip is towards the sill. See Figure 60 and Figure 61.



Figure 60

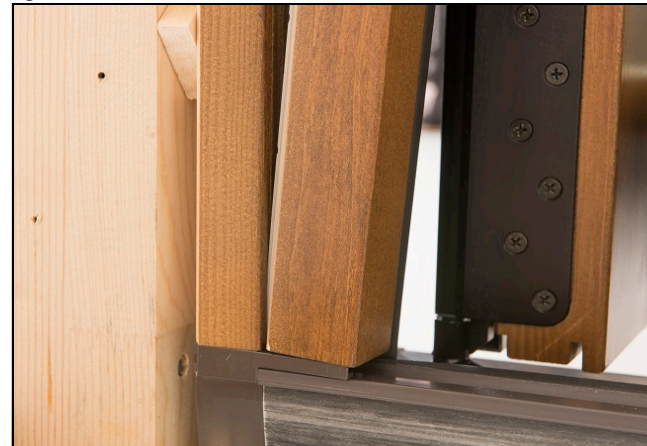

Figure 61

7. Apply corner gasket between sill and wood part stop. Reapply weather strip at side jamb and sill. See Figure 62.

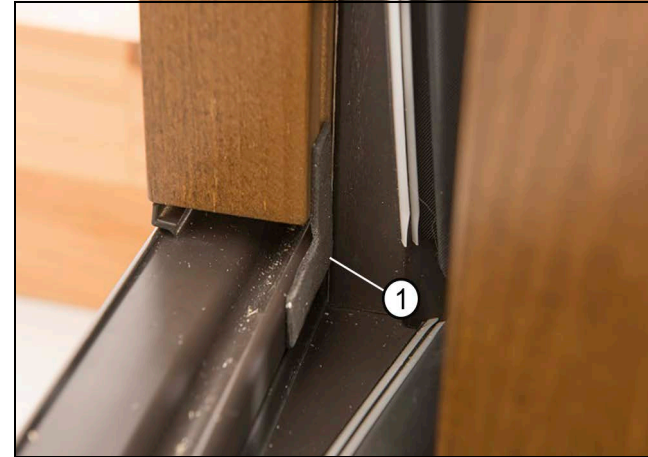

Figure 62

1	Corner gasket
---	---------------

8. Install panel alignment bolt(s) into pre-drilled holes on jambs where wall pivot hinge sets are located. See Figure 63.



Figure 63

1	#8 x 3 1/2" Flat head BLK or BG
---	---------------------------------

9. If needed, install strike plate in to pre-drilled holes. Ensure support block does not interfere and there are shims behind jamb. See Figure 64.



Figure 64

1	#8 x 3 1/2" Flat head
---	-----------------------

10. At all shoot bolt locations, slightly open panels and measure 1 1/2" from the edge of the panel to the center of the strike location. Snap plastic sill strikes into place and ensure shoot bolt makes contact (if screw is need to hold sill strike in place, use #6 x 1/4" stainless steel flat head screw). See Figure 65 and Figure 66.



Figure 65



Figure 66

11. For performance sill only, peel tape backing off of the interior sill liner and rotate liner on to sill. See Figure 67 and Figure 68.



Figure 67

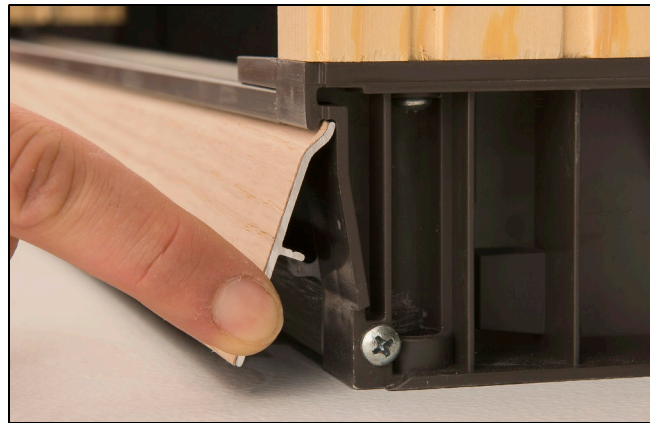

Figure 68

12. Apply the adhesive backed hinge weather strip on any hinges next to a jamb. See Figure 69.

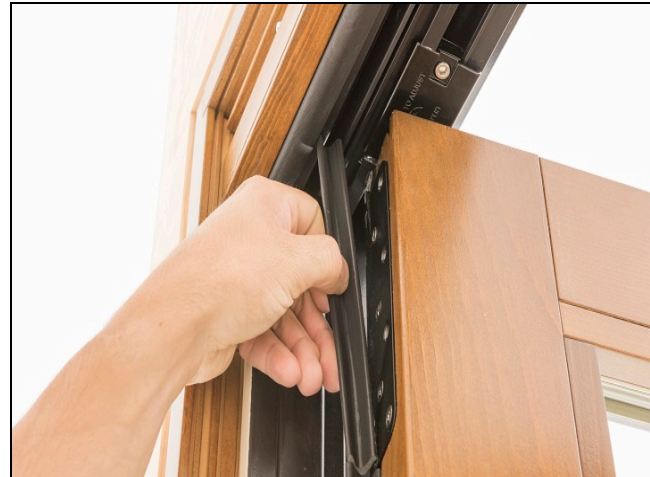

Figure 69

13. Apply panel edge gasket. See Figure 69.

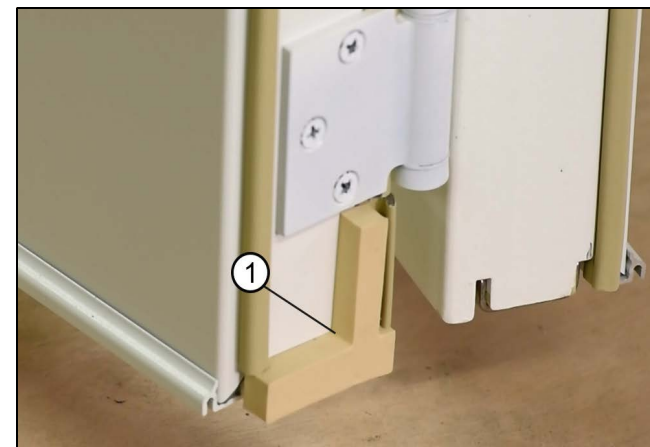

Figure 70

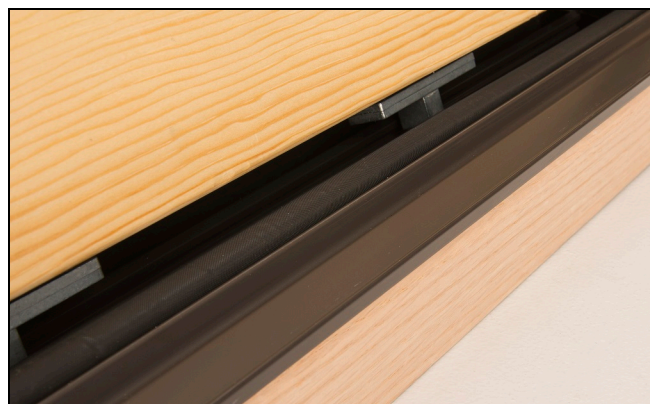

Figure 71

### Stationary Panel Installation

1. Ensure frame covers are installed from step 4 in "Final Component Installation"
2. From the exterior side, tip the panel into place by placing the two sill bolts into the interior track of the sill. See Figure 71.

3. Flush the interior side of the jamb brackets with the interior side of the frame covers, pre-drill, and fasten the panel to the frame. See Figure 72.

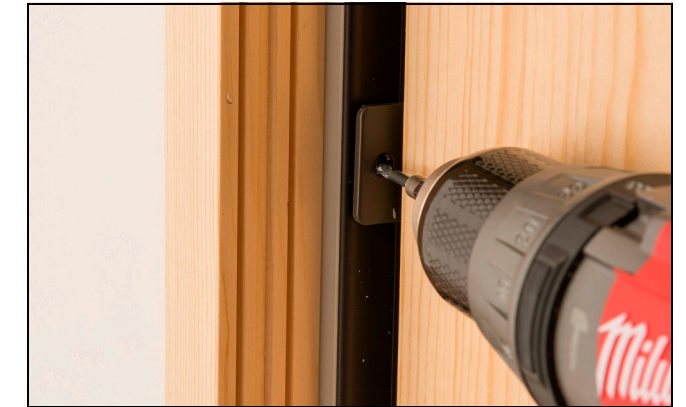

Figure 72

### Technical Installation Specifications

The following details are specified for proper installation and for the unit to meet the advertised design pressure (DP) rating.

- Rough Opening Width: 1/4" - 1" (6-25) wider than window/door frame outside measurement.
- Rough Opening Height: 1/4" - 1/2" (6-13) higher than window/door frame outside measurement.
- Masonry Opening Width: 1/4" - 1/2" (6-13) wider than window/door frame outside measurement.
- Masonry Opening Height: 1/8" - 1/4" (3-6) higher than window/door frame outside measurement.
- The panning must drain water to the exterior of the cladding OR the exterior surface of a concealed weather resistive barrier.
- Properly flash and/or seal all windows at the exterior, perimeter.
- Sealants used for installation must be Grade NS Class 25 per ASTM C920 and compatible with the building exterior, window exterior surface, and flashing/water management materials.
- Optional foams used for installation must be low expansion only. Foam and foam application must comply with ASTM E2112-01, SEC 5.9.2
- For units with flat casing install with installation brackets, structural masonry brackets, or jamb screws.

### ! CAUTION!

Be aware that the use of sill pans and other barriers will decrease the rough opening height clearance. Adjust opening dimensions accordingly.

- Shims 4" - 6" (102-152) from each corner on jambs and head jambs. Install additional shims at 15" (381) on center and at all locking points. always shim at the check rails and meeting stiles.
- Do not use chemically treated products for shim material.
- fasteners penetrating chemically treated lumber must be a minimum of 0.90 oz/ft<sup>2</sup> zinc hot dipped galvanized or stainless steel type 304 or 316.
- The window frame must not come into direct contact with chemically treated wood products.
- The panning system used in these instructions is one component in a structure's overall water management system. It should be used in conjunction with an appropriate drainage plane compatible with the exterior cladding.
- Flashing materials must comply with ASTM E2112-01, section 5.13 and be compatible with all materials used in installation including panning systems, air barriers and building papers, sheathing, and the window unit.