

Elevate Outswing French Door G3

KD (Knock Down) Installation Instruction



Abstract

Please read these instructions in their entirety before beginning to install your Marvin Door product. These installation instructions demonstrate the installation of an Marvin door in new wood frame construction using an industry approved water management system. For installation using other construction methods, such as remodeling, replacement, and recessed openings refer to ASTM E2112-07, "Standard Practice for Installation of Exterior Windows, Doors and Skylights," for installation suggestions. The same information for ASTM E2112 can be found on the ASTM website, www.astm.org. Regional standard practices, environmental conditions, and codes may vary and supersede the procedures contained within. The responsibility for compliance is yours: the installer, inspector, and owner(s).

After Market Products

Alterations to Marvin products including films, insulating or reflective interior window treatments or additional glazings can cause excessive heat buildup and/or condensation. They may lead to premature failures not covered under warranty by Marvin Windows and Doors.

Before purchasing or applying any product that may affect the installation or performance of Marvin doors, contact the manufacturer of after market product/glazings that are not supplied by Marvin and request written product use, associated warranties and damage coverage. Provide this information and warranties to the end user and/or building owner for future reference.

This instruction is applicable to units produced after June 24, 2024.

WARNING!

Always practice safety! Wear the appropriate eye, ear, and hand protection, especially when working with power tools.

WARNING!

This product can expose you to chemicals including titanium oxide, which is known to the state of California to cause cancer. For more information, go to www.P65Warnings.ca.gov.

WARNING!

Drilling, sawing, sanding or machining wood products can expose you to wood dust, a substance known to the State of California to cause cancer. Avoid inhaling wood dust or use a dust mask or other safeguards for personal protection. For more information go to www.P65Warnings.ca.gov/wood.

IMPORTANT

All images are for illustrative purposes only. Images are meant to enhance understanding and are not necessarily exact representations of the unit.

You Will Need to Supply

- Safety Glasses
- Hearing protection
- Caulking Gun
- Mallet
- Drill
- Phillips #2 screwdriver
- Phillips #2 bit
- 1/8" drill bit
- Step ladder
- 25' Tape measure
- Utility knife
- Wood support blocks
- Level and/or laser
- Wood shims
- 2" Roofing nails (for Nailing Fin Installation)
- Insulation
- Perimeter sealant
- Sill Panning
- Backing material (foam backing rod)
- Low expansion foam insulation
- Flashing materials
- Weather resistive barrier
- 5/32" Hex Key
- String line
- Suction cups
- Lifting equipment

Frame Assembly

1. Insert corner keys into side jambs. See Figure 1.

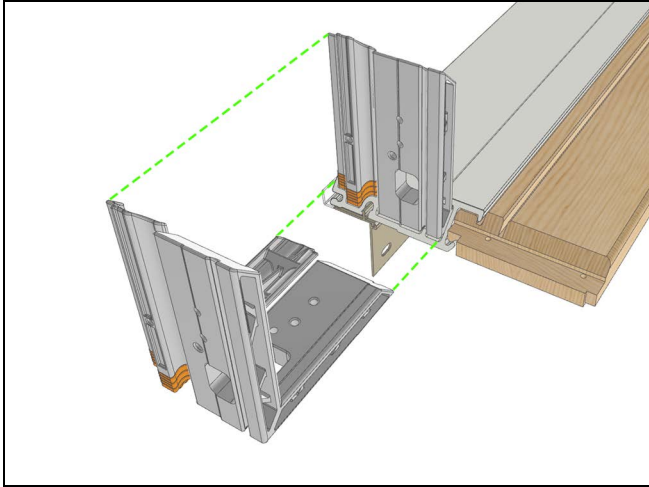

Figure 1

2. Fasten the side jambs to the head jamb. Do not over tighten miter joint. See Figure 2.

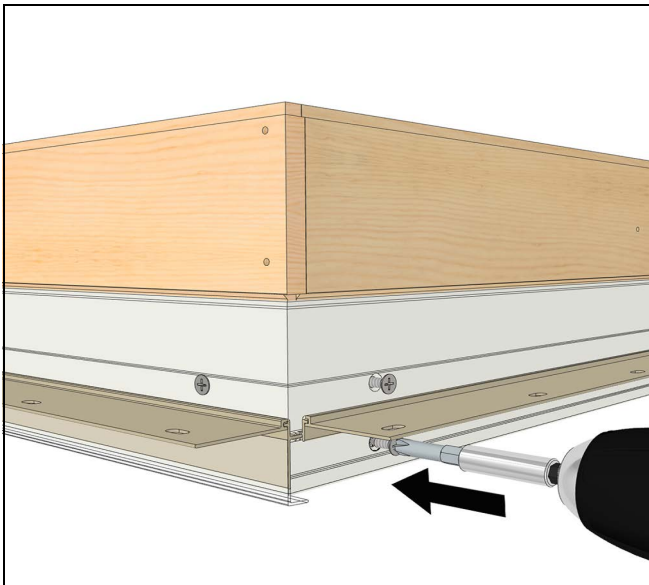

Figure 2

1	Four per side- #8 x 1/2" Flat head screws
---	---

3. Head jamb liner is pre-drilled, fasten with provided screws. See Figure 3.

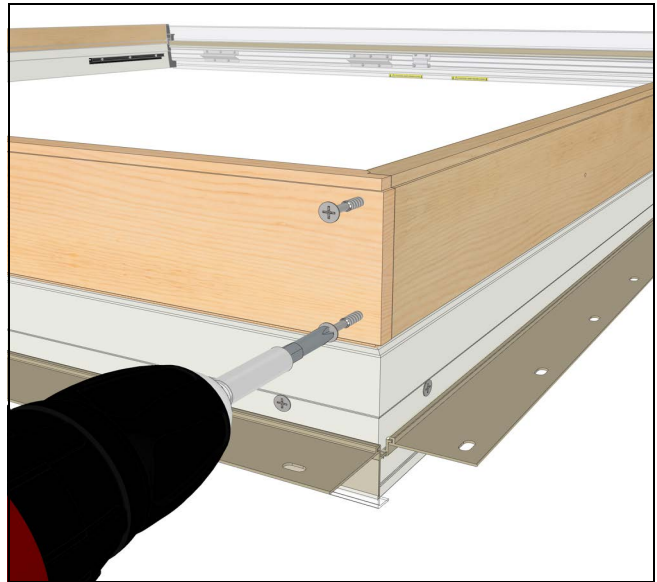

Figure 3

1	2 per side- #8 X 1-1/4" PH Flat Head
---	--------------------------------------

4. Fasten the sill to the side jambs (short screws first and replace the interior sill screw with the 4" panhead). See Figure 4.



Figure 4

1	2 per side- #8 x 1/2" flat head screws
2	1 per side- #8 x 4" pan head screw

5. Inject the sill until squeeze out occurs in both locations. *Note: Inject the exterior most hole first and the interior second.* Clean up excessive silicone squeeze out as necessary. See [Figure 5](#) and [Figure 6](#).

ATTENTION

Ensure you see silicone at specified indicators to ensure proper injection and water performance.

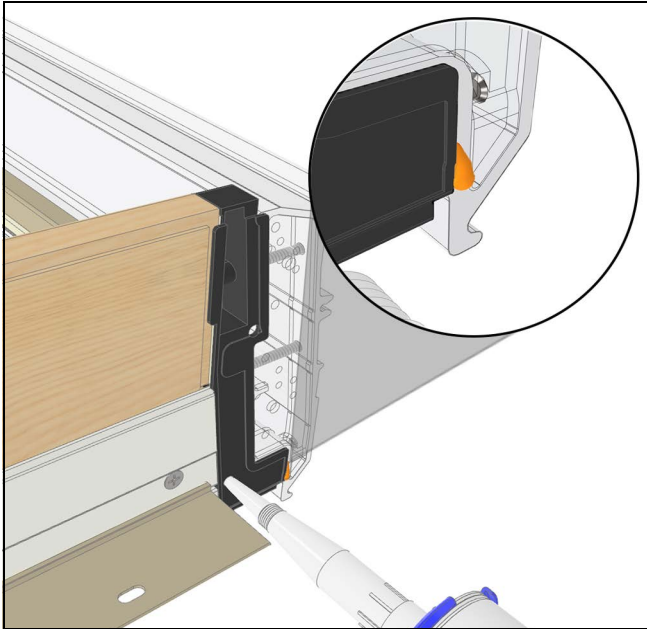

Figure 5

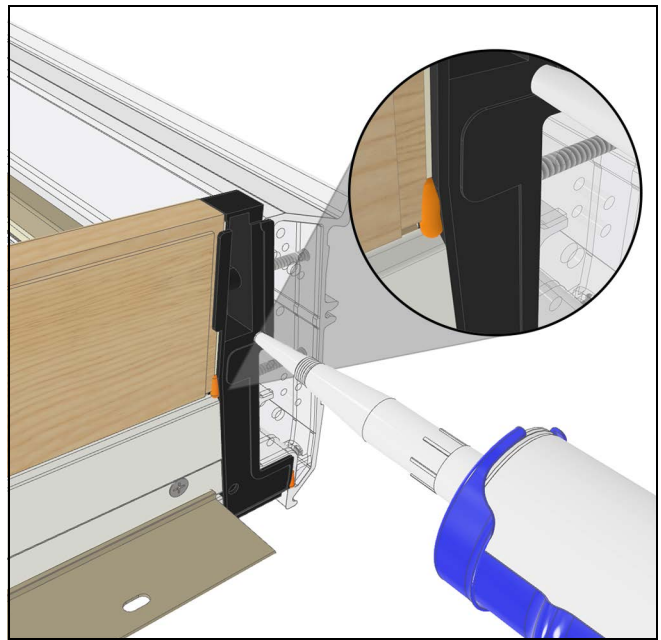

Figure 6

Frame Installation

Please refer to the standard and general installation instructions for rough opening prep and frame installation steps.

Panel Installation Table of Contents

O Panel.....5
 X/XX Panels.....5
 OO Panels.....6
 OXR/XOL Panels.....7
 XOR/XOL Panels.....8
 OXO Panels.....10

O Panel

1. Panel is tipped into place and should engage with the clip on the frame. See Figure 7.
2. See standard install instructions for panel stop installation.

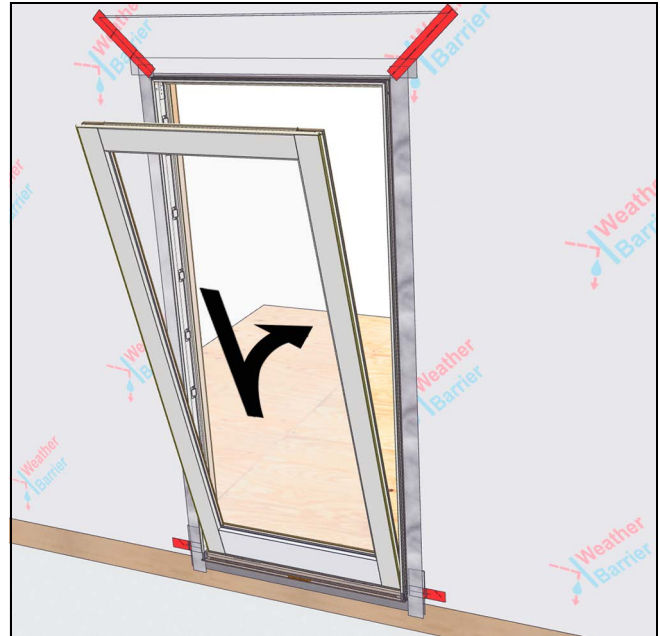

Figure 7

X/XX Panels

1. Frame comes with hinges pre-installed. Fasten panel to frame using #4 x 2-1/2" matching screws to attach each hinge of the panel. Adjust panels for reveal and closure after install. See Figure 8.

2. See standard install instructions for panel stop installation.

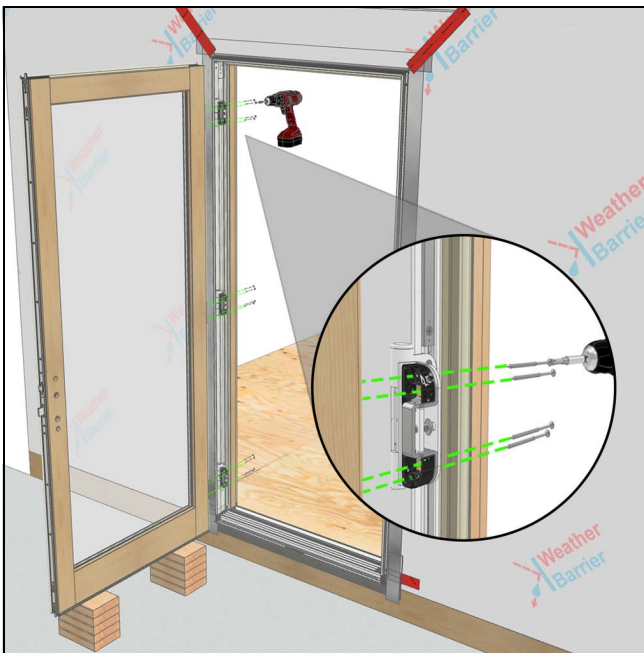

Figure 8

OO Panels

1. From the exterior, place the first panel (the one with the interior astragal) on the set of sill retainers. Tip the panel towards the interior and slide it towards the opposite side until the panel engages with the jamb retainers and sill retainer. See Figure 9.

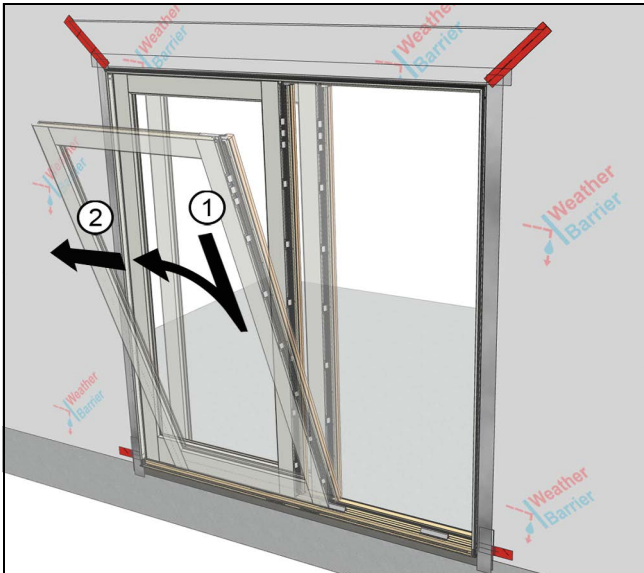

Figure 9

2. Remove one screw (pan head from the panel). See Figure 10.

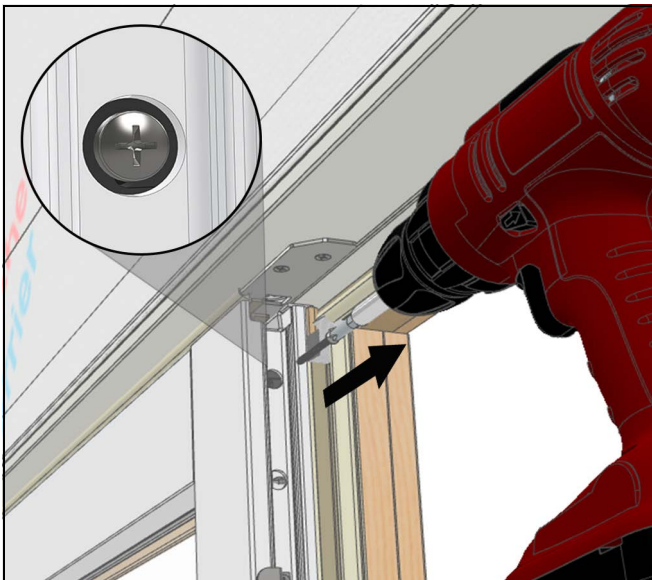

Figure 10

3. Seat the lock bar into the panel Eurogroove and up into the head jamb strike aligning top hole on lock bar to the removed screw hole already in the panel. See Figure 11. Be mindful not to overshoot the bolt as this will cause the head jamb to bow upward.

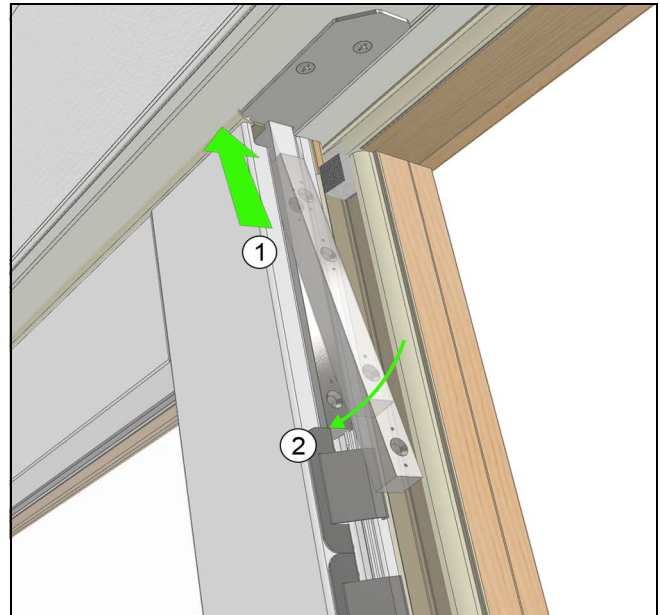

Figure 11

4. Install the 2-1/2" stainless flat head screw into the hole left by removing the panel screw. Fasten until it sits flat with the lock bar face. Drive another 2-1/2" stainless screw into the other hole until it sits flat with the lock bar face. See Figure 12.

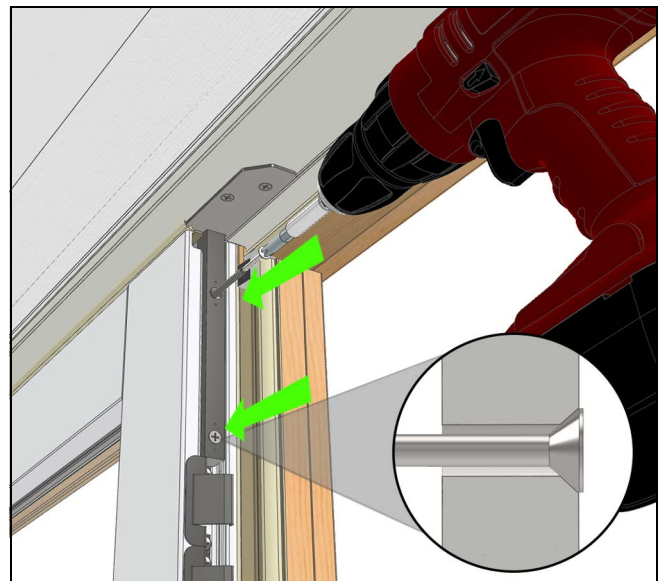

Figure 12

5. To install the second panel in an OO place the panel on the sill on top of the brackets angled toward the exterior and rotate into the opening. Clips should engage.

6. See standard install instructions for panel stop installation.

OXR/XOL

1. Stationary panel is installed first by tipping panel in over the sill retainer and then sliding over and engaging the panel bracket into the sill retainer and jamb retainers. See Figure 13.

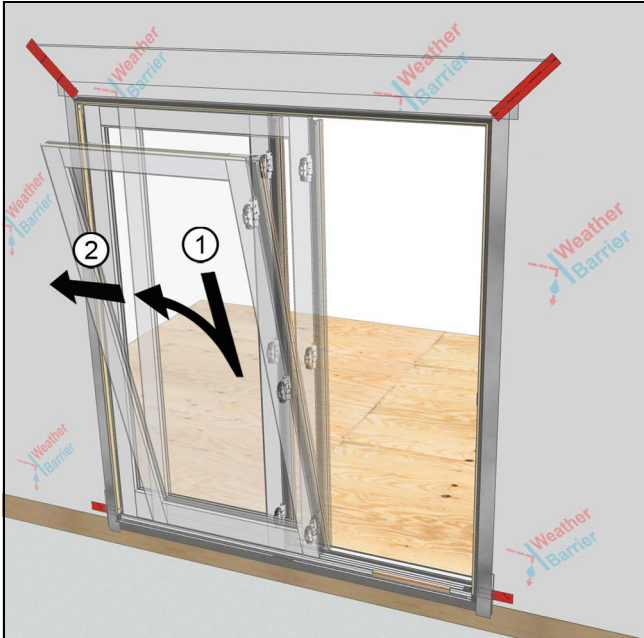

Figure 13

2. Remove one screw (pan head from each panel). See Figure 14.

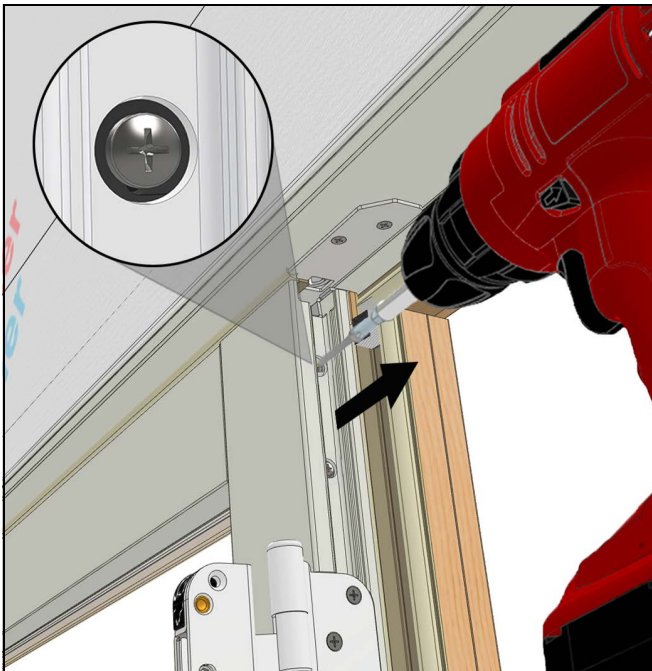

Figure 14

3. Seat the lock bar into the panel Eurogroove and up into the head jamb strike aligning top hole on lock bar to the removed screw hole already in the panel. Be mindful not to overshoot the bolt as this will cause the head jamb to bow upward. See Figure 15.

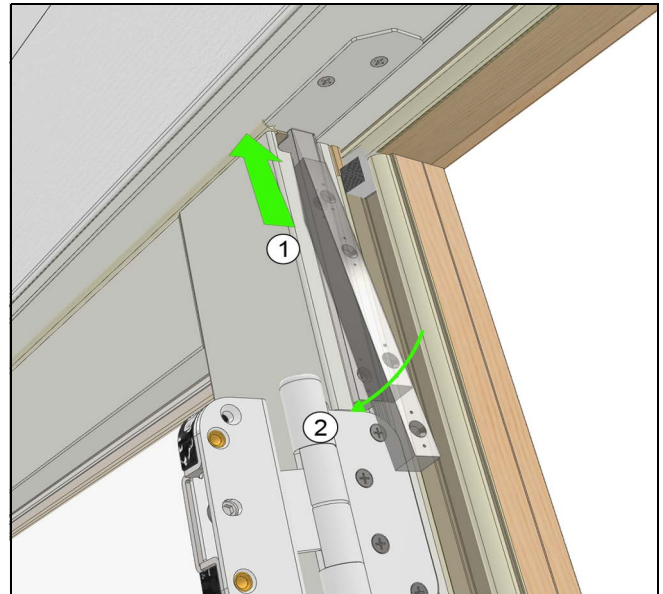

Figure 15

4. Install the 2-1/2" stainless flat head screw into the hole left by removing the panel screw. Drive until it sits flat with the lock bar face. Pre-drill and then fasten another 2-1/2" stainless screw into the other hole until it sits flat with the lock bar face. See Figure 16.

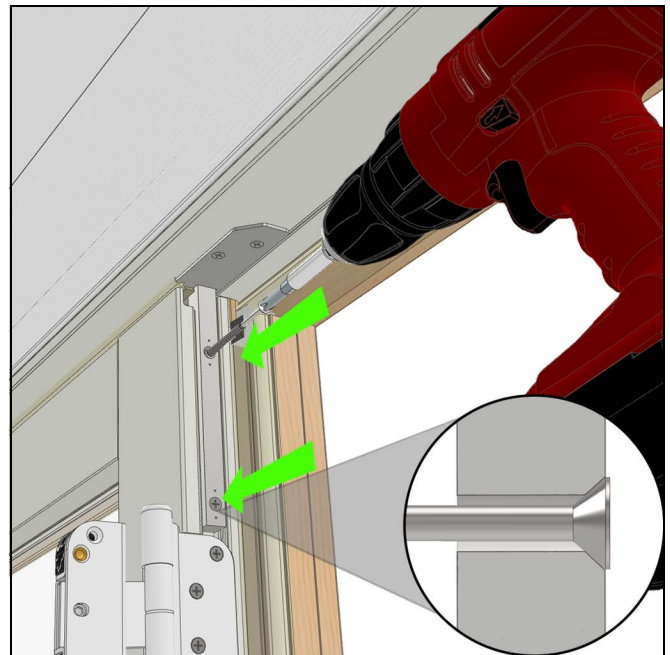

Figure 16

5. Fasten 4 x 2-1/2" matching screws are used to attach each hinge of the panel. Hinges are pre-applied to stationary panel on the swinging jamb. See [Figure 17](#)

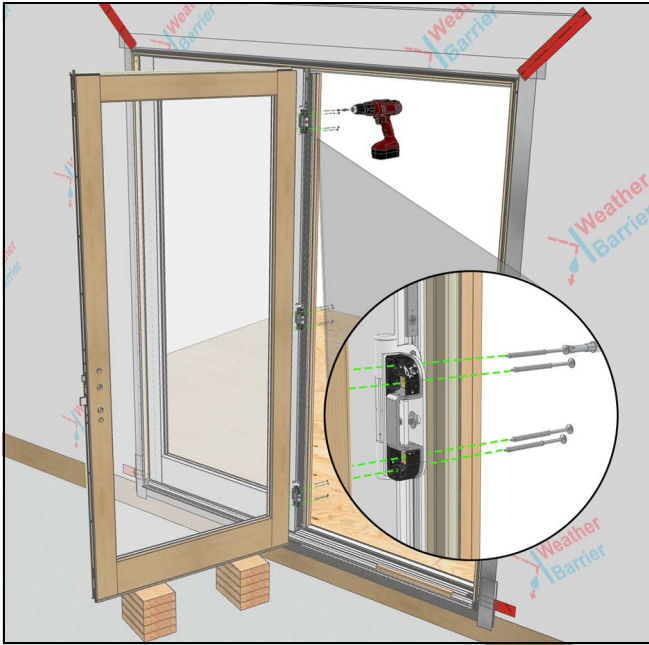

Figure 17

6. Install sill strike using sill color-matched 8-18 x 3/4" pan head screw. See [Figure 18](#)

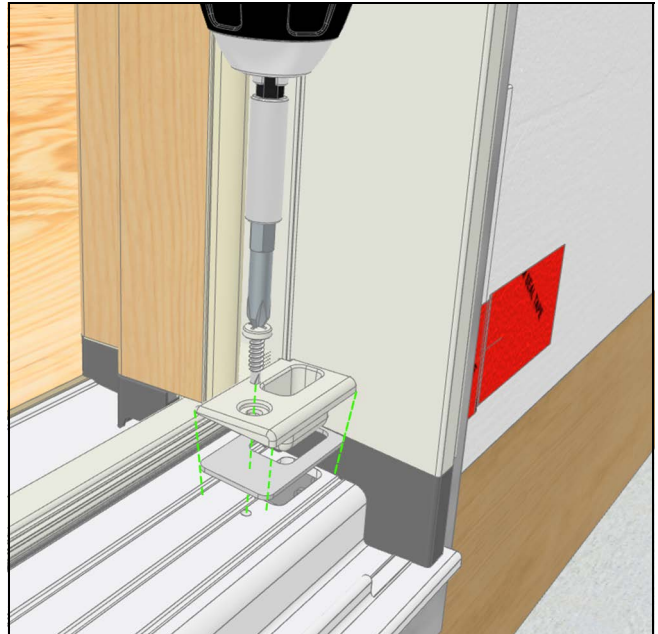

Figure 18

7. See standard install instructions for panel stop installation.

XOR/OXL Panels

1. Ensure sill strike is not installed into the sill prior to installing the stationary panel to avoid catching stationary panels retainer bracket on the strike. See [Figure 19](#).

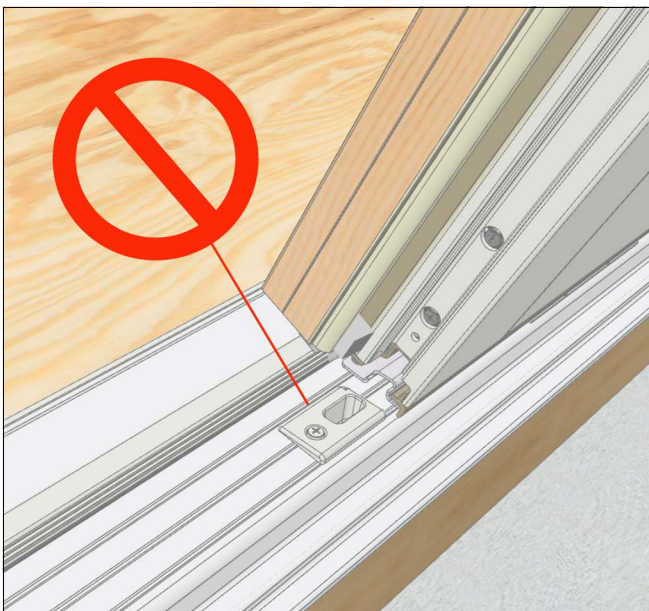

Figure 19

2. Stationary panel is installed first by tipping panel in over the sill retainer and then sliding over and engaging the panel bracket into the sill retainer and jamb retainers. See [Figure 20](#).

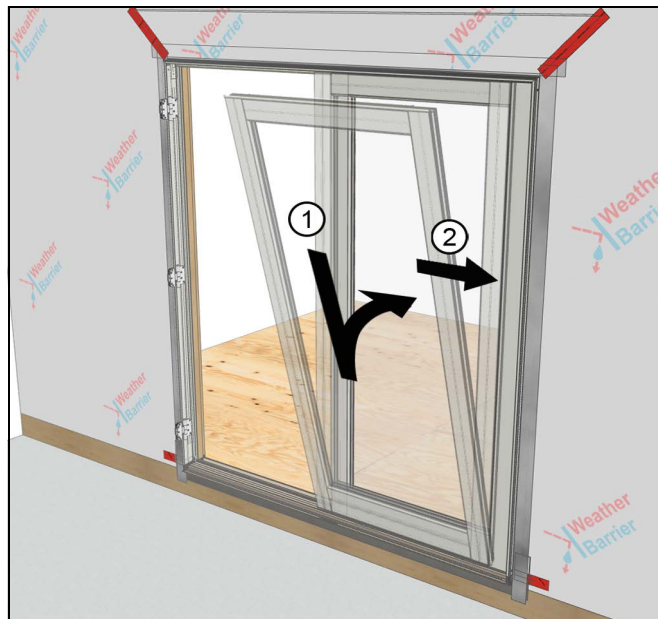

Figure 20

3. Install sill strike using sill color-matched 8-18 x 3/4" pan head screw. See [Figure 21](#).

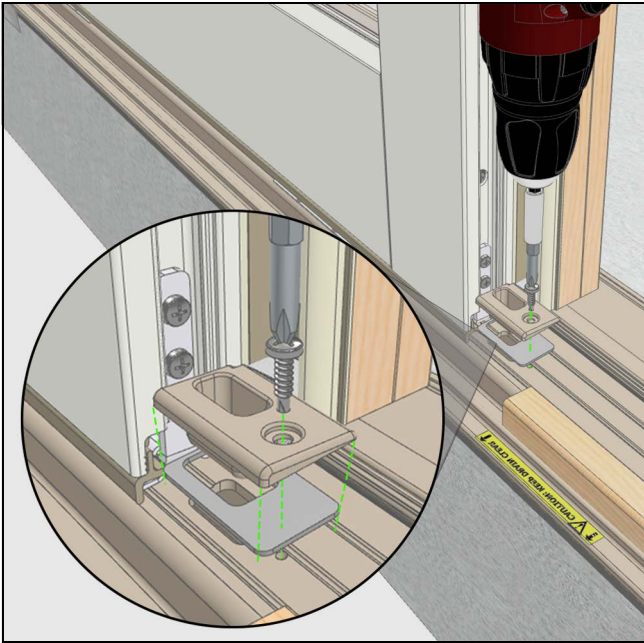

Figure 21

4. Remove one screw (pan head from each panel). See [Figure 22](#).

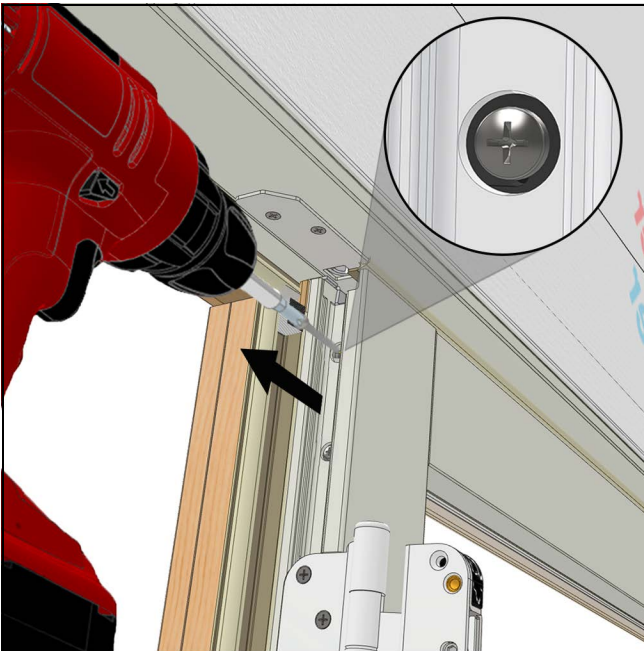

Figure 22

5. Seat the lock bar into the panel Eurogroove and up into the head jamb strike aligning top hole on lock bar to the removed screw hole already in the panel. *Be mindful not to overshoot the bolt as this will cause the head jamb to bow upward.* See [Figure 23](#).

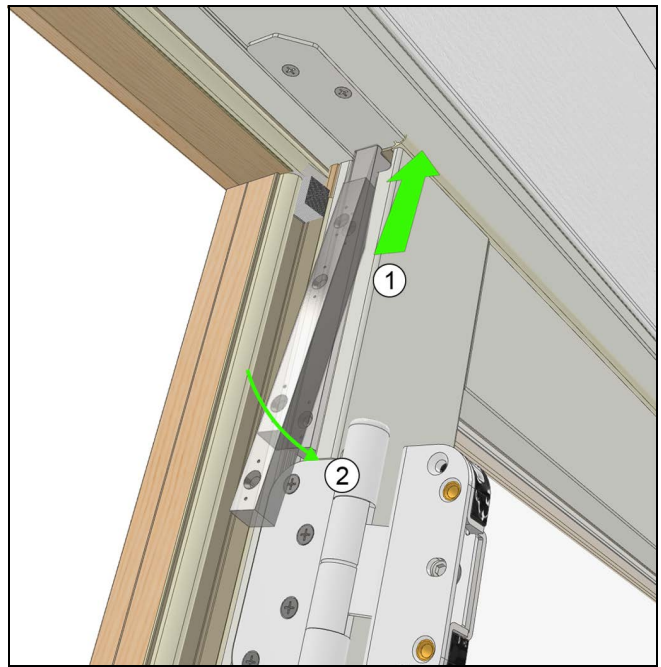

Figure 23

6. Install the 2-1/2" stainless flat head screw into the hole left by removing the panel screw. Drive until it sits flat with the lock bar face. Pre-drill and then fasten another 2-1/2" stainless screw into the other hole until it sits flat with the lock bar face. See [Figure 24](#).

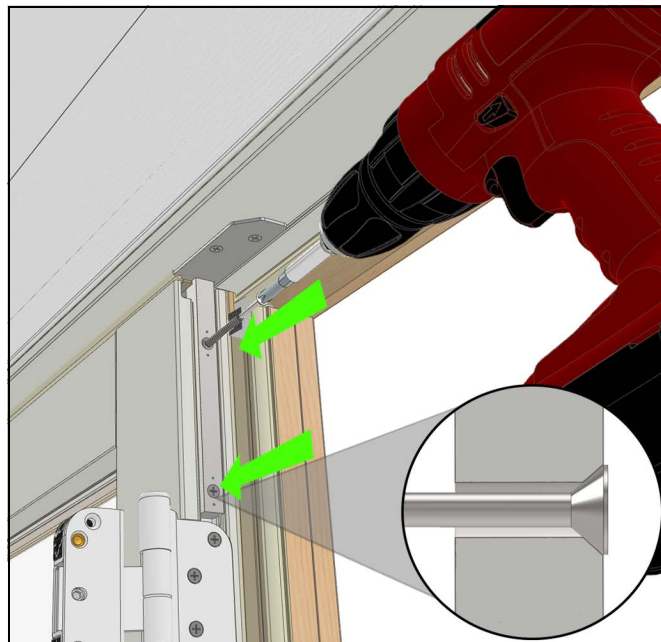

Figure 24

7. Fasten 4 x 2-1/2" matching screws are used to attach each hinge of the panel. Hinges are pre-applied to stationary panel on the swinging jamb. See [Figure 25](#)

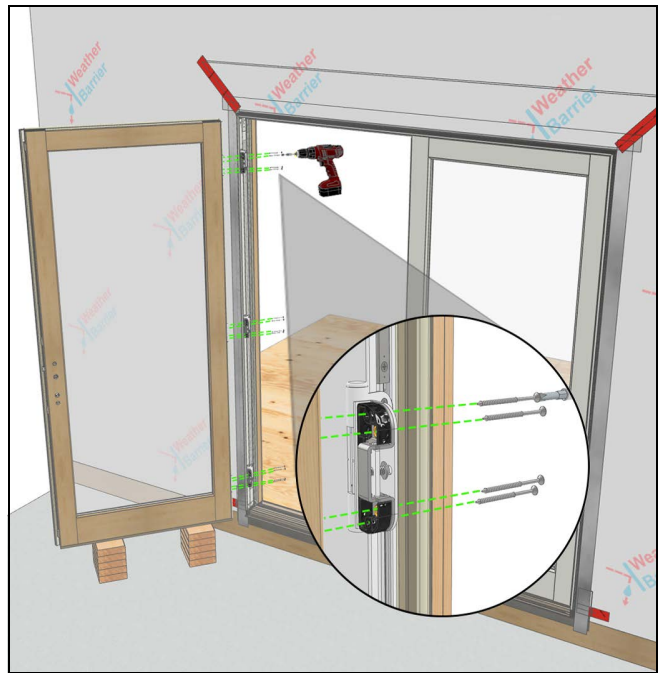

Figure 25

8. See standard install instructions for panel stop installation.

OXO Panels

1. Ensure sill strike is not installed into the sill prior to installing the stationary panel to avoid catching stationary panels retainer bracket on the strike. See [Figure 26](#).

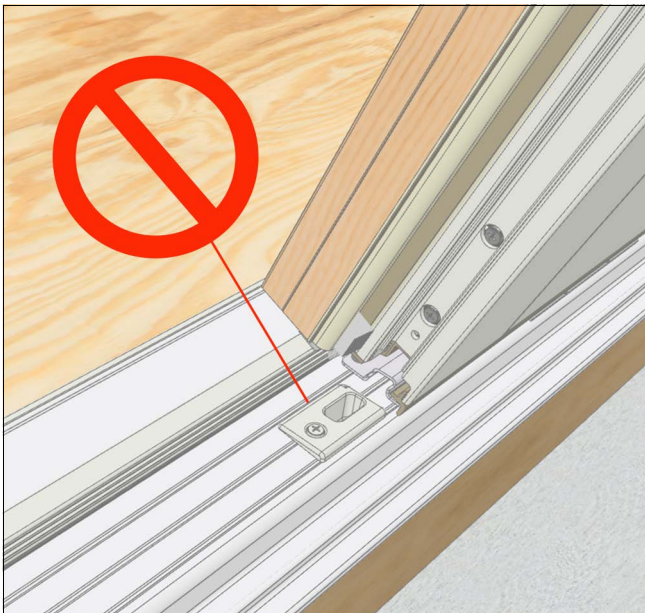

Figure 26

2. Stationary panel is installed first by tipping panel in over the sill retainer and then sliding over and engaging the panel bracket into the sill retainer and jamb retainers. See [Figure 27](#). It's recommend to install one stationary panel at a time following steps 3-5 and then repeating for the other panel.

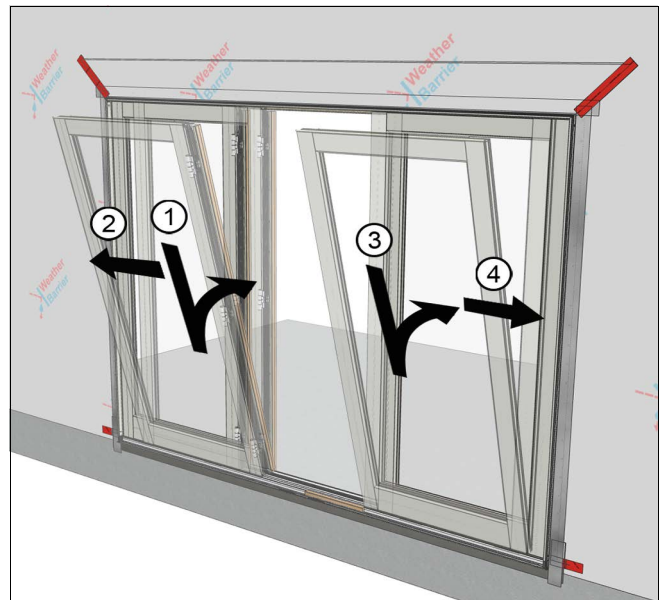

Figure 27

3. Remove one screw (pan head from each panel). See [Figure 28](#).

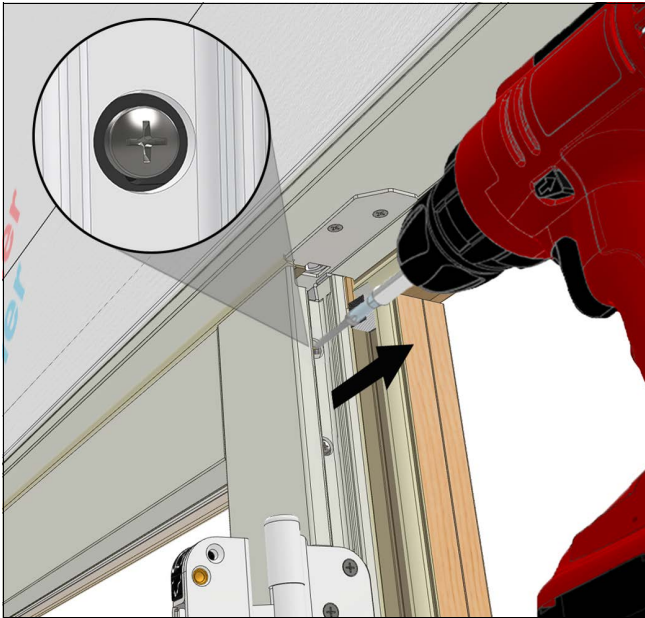

Figure 28

4. Seat the lock bar into the panel Eurogroove and up into the head jamb strike aligning top hole on lock bar to the removed screw hole already in the panel. See [Figure 29](#). *Be mindful not to overshoot the bolt as this will cause the header to bow upward.*

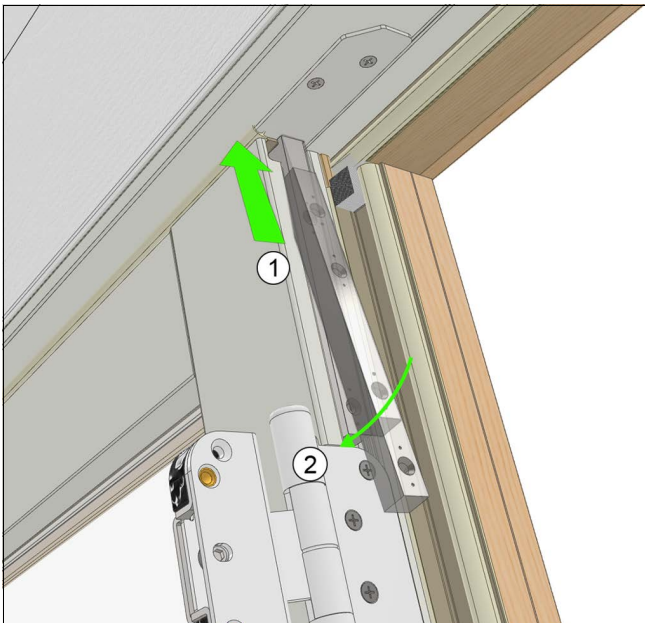

Figure 29

5. Install the 2-1/2" stainless flat head screw into the hole left by removing the panel screw. Drive until it sits flat with the lock bar face. Remove one screw (pan head from each panel). Pre-drill and fasten another 2-1/2" stainless screw into the other hole until it sits flat with the lock bar face. See [Figure 30](#).

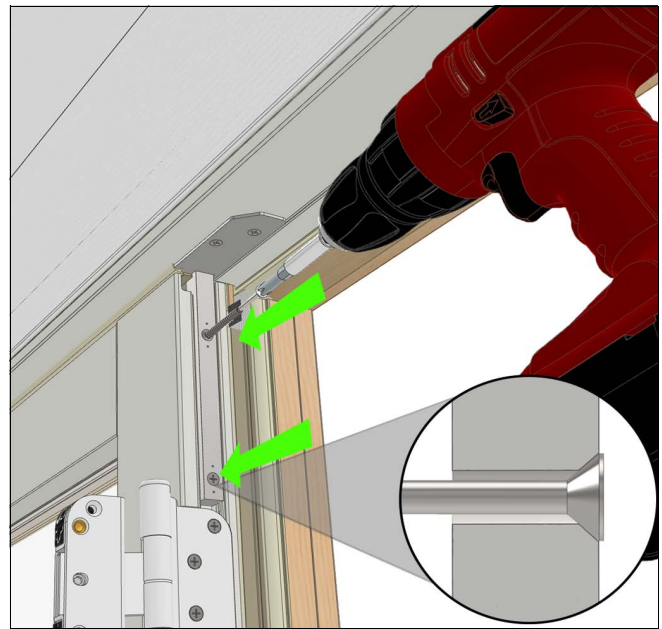

Figure 30

6. Install the sill strike using the sill color matched 8-18 x 3/4" pan head screw. See [Figure 31](#).

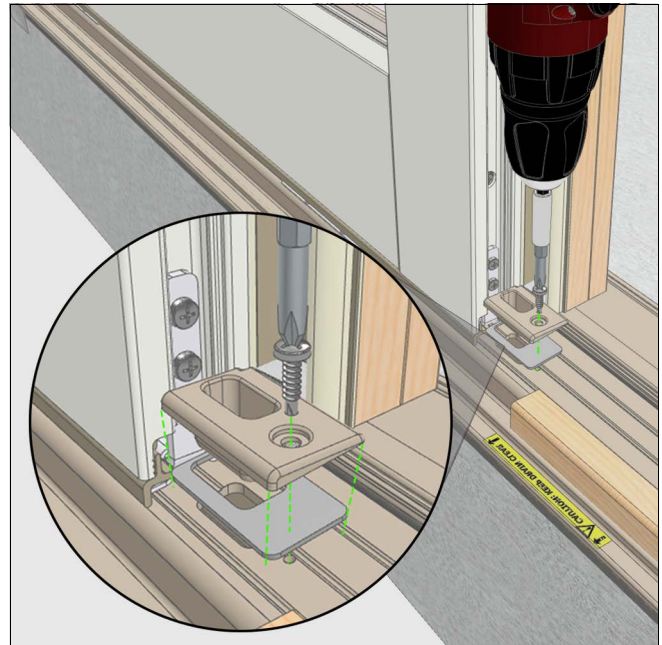

Figure 31

7. Fasten 4 x 2-1/2" matching screws are used to attach each hinge of the panel. Hinges are pre-applied to stationary panel on the swinging jamb. See [Figure 32](#).

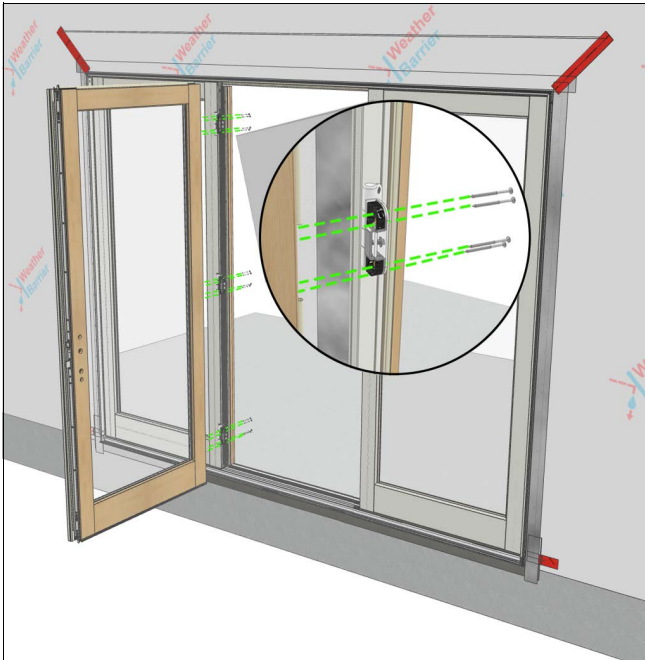

Figure 32

8. See standard install instructions for panel stop installation.

IMPORTANT

Avoid closing the panels until panels have been installed and adjusted to avoid damage to the sill.

⚠ CAUTION!

When installing and adjusting panels, use caution to avoid damage to weather stripping.

Technical Installation Specifications

The following details are specified for proper installation and performance of the Marvin Door.

- Rough Opening Width: 1/4"-1" (6-25) wider than door frame outside measurement.
- Rough Opening Height: 1/4"-1/2" (6-13) higher than door frame outside measurement.
- Masonry Opening Width: 1/4"-1/2" (6-13) wider than door frame outside measurement.
- Masonry Opening Height: 1/8"-1/4" (3-6) higher than door frame outside measurement.
- Properly flash and/or seal all doors at the exterior perimeter.
- Sealants used for installation must be Grade NS Class 25 per ASTM C920 and compatible with the building exterior, door exterior surface, and flashing/water management materials.
- Construction adhesive must be APA rated AFG-01 SPEC.
- Flashing materials must comply with ASTM E2112-07, section 5.13 and be compatible with all materials used in installation including panning systems, air barriers and building papers, sheathing, and the door unit.
- The following materials were used to develop these instructions:

Weather Resistant Barriers: DuPont™ Tyvek® Home-Wrap or Grade D building paper.

Flashing Materials: DuPont™ FlexWrap or DuPont™ Straight Flash, DuPont™ Tyvek® Tape.

Sealant: OSI® Quad Pro-Series®; solvent release butyl rubber sealant or DAP DynaFlex230™.

- Optional foams used for installation must be low expansion only. Foam and foam application must comply with ASTM E2112-07, SEC 5.9.2.
- Fasteners penetrating chemically treated lumber must be a minimum of 0.90 oz/ft² zinc hot dipped galvanized or stainless steel type 304 or 316.
- Shim 4"-6" (102-152) from each corner, at every point of attachment, and 15" maximum on-center.