



Ultimate Wood Outswing French Door Arch Top

Replacement Parts

Specifications and technical data are subject to change without notice.

Numbers listed in () parentheses are metric equivalents in millimeters rounded to the nearest whole number.

Suggested fasteners are not included and must be ordered separately.

Illustrations are not to scale.

Contents

Product History.....	2
Part Identification - Operator XX.....	3
Installation Parts.....	4
Traditional Handle.....	5
Contemporary Handle	11
Handle - Keyed Cylinder.....	16
Handle Set - Discontinued No Availability (NA).....	17
Hinge Handing Location	21
Hinges.....	22
Hinges - Discontinued No Availability (NA).....	24
Locking Hardware	25
Miscellaneous Parts	30
Miscellaneous Parts - Discontinued No Availability (NA).....	31
Aluminum Parts	36
Fiberglass Parts.....	37
Fiberglass Parts - Discontinued No Availability (NA).....	38
Vinyl Parts.....	39
Vinyl Parts - Discontinued No Availability (NA).....	41
Wood Parts.....	42
Wood Parts - Discontinued No Availability (NA).....	43
Weather Strip	44
Weather Strip - Discontinued No Availability (NA).....	46
Panel Replacement	47
Combination Door - Wood Parts	48
Combination Door - Vinyl Parts	49
Combination Door Parts - Discontinued No Availability (NA).....	51

Produced	Unit Type	Features and Changes
1991	Ultimate Wood Outswing French Door Arch Top	Unit features 3/4" interior glazed insulating glass, 4 9/16" jambs, multi-point hardware with solid brass handles and hinges, beige Lexan sill and beige external component parts. One panel doors feature 32 3/32" frame radius, two panel doors feature 63 5/8" frame radius. Units available in CN 6-8, CN 7-0 and CN 8-0 heights. All bottom rails 8 1/8". Pine interior trim and plinth blocks standard. Outswing unit features 4 9/16" or 6 9/16" one piece frame (extended to the exterior). Exterior factory finish available. Combination introduced featuring interchangeable screen and storm inserts and complete brass hardware.
1992	Ultimate Wood Outswing French Door Arch Top	Simulated divided lite option introduced.
1993	Ultimate Wood Outswing French Door Arch Top	Optional oak interior trim and plinth blocks introduced.
1994	Ultimate Wood Outswing French Door Arch Top	Beige Lexan sill changed to beige composite sill.
2000	Ultimate Wood Outswing French Door Arch Top	09/25/2000: Redesign to match current rectangle Outswing and Outswing door designs.
2003	Ultimate Wood Outswing French Door Arch Top	03/31/2003 Satin Taupe (TP) hardware replaces Brass as standard hardware. Standard door now includes hardware (no lock, no bore now an option). Strikes for Satin Taupe, Brushed Chrome, Polished Chrome and White are Stainless Steel. 07/2003 Ultimate French Door Arch Top introduced. Change in Rough Opening radius for one panel doors to 40 1/2" and for two panel doors to 72 1/2". Added radius SDL.
2004	All	01/2004 Added Oil Rubbed Bronze and Satin Chrome to available hardware finishes. 04/12/2004 Satin Nickel hardware finish introduced. Polished Chrome finish hardware is retired.
2005	All	Arch Top Doors become Ultimate Arch Top Doors. Outswing sills upgraded for water infiltration introduced optional bronze ultrex sill with black weather strip. 02/27/2005: Introduced Brass PVD and Satin Nickel PVD finishes to French door handles, adjustable hinges, and other miscellaneous parts. 06/15/2005: Changed jamb leaf on adjustable hinge to closed knuckle design.
2007	All	2/20/2007: Introduced raised and flat panels as a standard option for Marvin French Doors and Commercial Doors. Introduced new Ultimate Swinging Screen along with an optional Storm Plus Insert.
2009	All	3/23/2009: Added LoE3-366" as a standard option for all products. Added Cedro Macho as a standard option for all clad products.
2011	Ultimate Wood Outswing French Door Arch Top	4/25/2011: Added LoE-180" as a standard option for all products. White painted interior finish option introduced for all products.
2012	All	7/30/2012: Stave Core added to our description for current finger joint/edge glue construction of door panels. Updated adjustable hinge. 10/29/2012: Interior Square Sticking/Glazing Bead option introduced. 12/17/2012: Introduced Clear Interior Finish option on all products.
2013	All	4/29/2013: Introduced interior stain options. Stain colors are Wheat, Honey, Leather, Hazelnut, Cabernet and Espresso. 12/16/2013: Added SN PVD Butt Hinge option.
2014	All	2/24/2014: Removed screen information and added new chapter for screen to manual.
2014	All	10/27/2014: Introduced Ogee as the new default for interior profiles.
2016	All	06/27/2016: Introduced Matte Black as a standard hardware color. 10/31/2016: Introduced 9-0 CN heights. Obsolescence of the wood species Cedro Macho for all products.

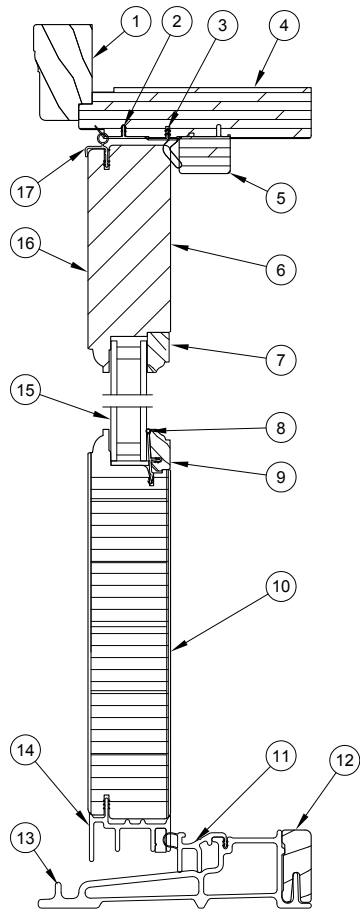

Head Jamb and Sill

- | | |
|---------------------------------|--|
| 1. Head Jamb Brick Mould Casing | 17. Panel Cover Weather Strip |
| 2. Frame Weather Strip | 18. Side Jamb Brick Mould Casing |
| 3. Head Jamb Stop Weather Strip | 19. Side Jamb |
| 4. Head Jamb | 20. Connecting Barb |
| 5. Head Jamb Stop | 21. Side Jamb Parting Stop |
| 6. Top Rail | 22. Inactive Panel Locking Stile |
| 7. Top Rail Glazing Bead | 23. Interior Handle Assembly |
| 8. Vinyl Glazing Bead | 24. Astragal Base |
| 9. Glazing Bead Cap | 25. Astragal Cover |
| 10. Bottom Rail | 26. Astragal Weather Strip |
| 11. Sill Weather Strip | 27. Side Jamb parting Stop Weather Strip |
| 12. Sill Liner | 28. Adjustable Hinge |
| 13. Sill | 29. Exterior Handle Assembly |
| 14. Sweep | 30. Stile Weather Strip |
| 15. Insulating Glass | 31. Active Panel Locking Stile |
| 16. Top Rail | |

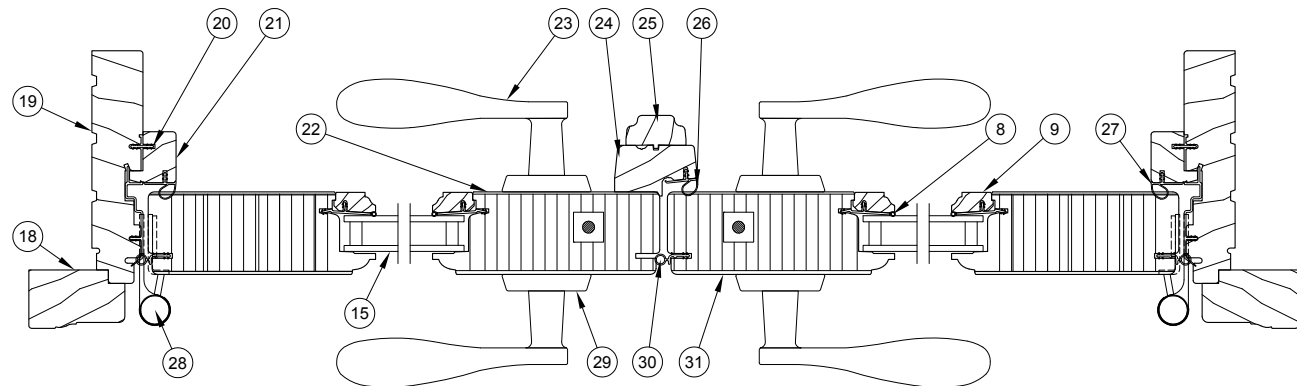

Jamb - XX L

Construction Handle

PN

10830451

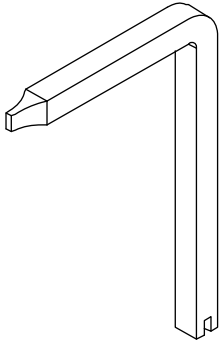

Handle Assembly, Active, Keyed

Mortise Lock and Multi-Point Lock Systems (Schlage "C" Keyway)

Includes:

- 1 - Interior lever with spindle, escutcheon plate and hardware
- 1 - Exterior lever with escutcheon plate and hardware
- 1 - Thumb turn with hardware (A)
- 1 - Keyed cylinder with housing and hardware (B)
- 1 - Exterior escutcheon plate gasket
- 2 - Lug Seal (C)
- 1 - Two piece spindle, 4.35" w/1 3/4" panel (D)
- 2 - #10-32 x 2 1/8" Phillips oval head machine screws (w/1 3/4" Panel) (E)
- 2 - Keys

Handle Assembly - 1 3/4 Panel	
Color	PN
Satin Taupe	10830304
Antique Brass	10830306
White	10830310
Satin Chrome	10830302
Oil Rubbed Bronze	10148111
Oil Rubbed Bronze PVD	10830300
Brass PVD	10830324
Satin Nickel PVD	10830421
Dark Bronze	10830330
Polished Chrome	10830308
Matte Black	10830450

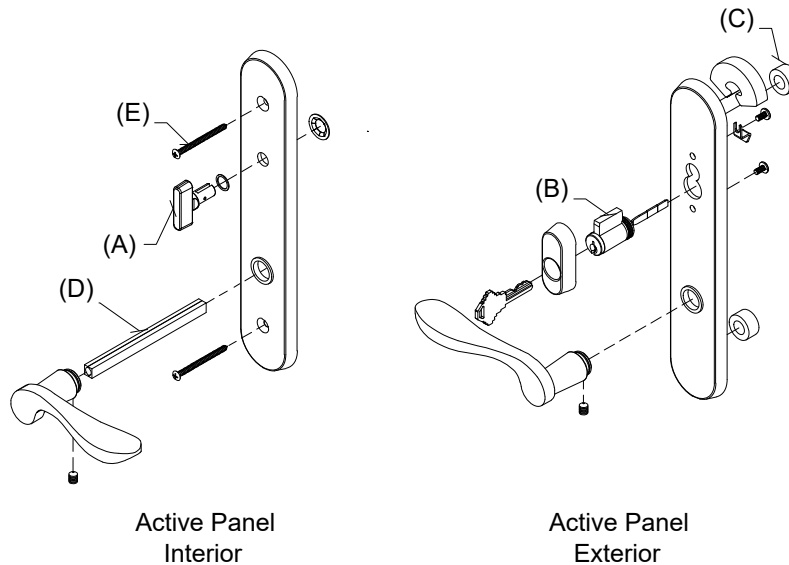

Handle Assembly, Active, Non-Keyed

Mortise Lock and Multi-Point Lock Systems (Schlage "C" Keyway)

Includes:

- 2 - Levers
- 2 - Lever bushings (D)
- 2 - Lug seals (C)
- 1 - Interior escutcheon
- 1 - Exterior escutcheon
- 1 - Thumb turn with actuator/tail piece (B)
- 1 - Two piece spindle, 4.35" w/1 3/4" panel (A)
- 2 - #10-32 x 2 1/8" Phillips oval head machine screws (w/1 3/4" Panel) (E)
- 2 - Set screws
- 1 - Allen wrench
- 1 - Installation instruction

Handle Assembly - 1 3/4 Panel	
Color	PN
Satin Taupe	10830514
Antique Brass	10830520
White	10830516
Satin Chrome	10830513
Oil Rubbed Bronze	10830512
Oil Rubbed Bronze PVD	10830510
Brass PVD	10830517
Satin Nickel PVD	10830521
Dark Bronze	10830518
Polished Chrome	10830515
Matte Black	10830519

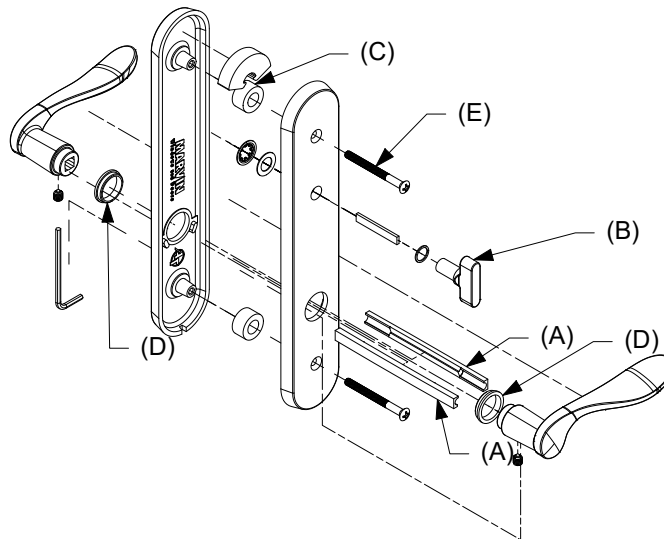

Handle Assembly, Inactive/Dummy

Includes:

- 1 - Interior lever with spindle, escutcheon plate and hardware
- 1 - Exterior lever with escutcheon plate and hardware
- 1 - Exterior escutcheon plate gasket
- 1 - Exterior escutcheon plate
- 2 - Lug seals (A)
- 1 - Two piece spindle, 4.35" (w/1 3/4" panel) (B)
- 2 - #10-32 x 2 1/8" Phillips oval head machine screws (w/1 3/4" Panel) (C)

Handle Assembly - 1 3/4 Panel	
Color	PN
Satin Taupe	10830318
Antique Brass	10830312
White	10830316
Satin Chrome	10830320
Oil Rubbed Bronze	10148154
Oil Rubbed Bronze PVD	10830322
Brass PVD	10830326
Satin Nickel PVD	10830422
Dark Bronze	10830328
Polished Chrome	10830314
Matte Black	10148157

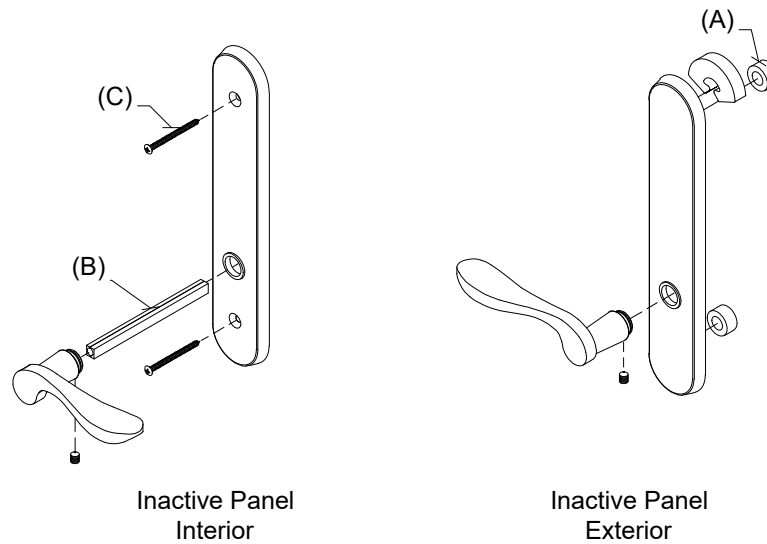

Thumb Turn, Traditional

For Keyed Handle

Includes:

Thumb Turn Washer
Thumb Turn Push Nut

No Tail Piece/Actuator (for keyed handle)	
Color	PN
Antique Brass	10148483
Satin Chrome	10148482
Oil Rubbed Bronze	10148481
Oil Rubbed Bronze PVD	10148485
Polished Chrome	10148488
Brass PVD	10148484
Satin Nickel PVD	10148487
Satin Taupe	10148486
Dark Bronze	10148479
White	10148489
Matte Black	10148480

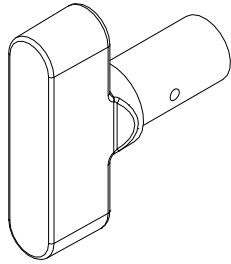

Thumb Turn, Traditional with Actuator/Tail Piece

For Non-Keyed Handle

Includes:

Actuator/Tailpiece
Thumb Turn Washer
Thumb Turn Push Nut

With Tail Piece/Actuator (for non-keyed handle)	
Color	PN
Antique Brass	10148495
Satin Chrome	10148494
Oil Rubbed Bronze	10148493
Oil Rubbed Bronze PVD	10148497
Polished Chrome	10148500
Brass PVD	10148496
Satin Nickel PVD	10148499
Satin Taupe	10148498
Dark Bronze	10148491
White	10148501
Matte Black	10148492

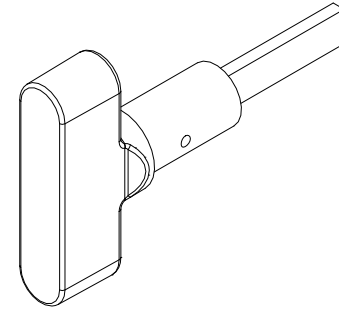

#10–32 x 2 1/8” Phillips Oval Head Machine Screw

Color	PN
Satin Taupe	11800616
Antique Brass	00143038
White	00143036
Satin Chrome	10840031
Oil Rubbed Bronze	10840032
Oil Rubbed Bronze PVD	11800160
Brass PVD	11800615
Satin Nickel PVD	11800190
Dark Bronze	11800654
Matte Black	11800181

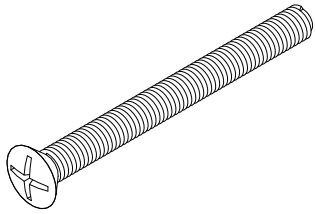

Handle Extensions

3/4” Handle Extension (Requires 3/4” Spindle Extension)		3/8” Handle Extension (Requires 3/8” Spindle Extension)	
Color	PN	Color	PN
Satin Taupe	10833060	Satin Taupe	10833049
Antique Brass	10833057	Antique Brass	10833046
White	10833063	White	10833052
Satin Chrome	10833056	Satin Chrome	10833045
Oil Rubbed Bronze	10833038	Oil Rubbed Bronze	10833044
Oil Rubbed Bronze PVD	10833059	Oil Rubbed Bronze PVD	10833048
Brass PVD	10833058	Brass PVD	10833047
Satin Nickel PVD	10830139	Satin Nickel PVD	10833050
Dark Bronze	10833054	Dark Bronze	10833042
Polished Chrome	10833062	Polished Chrome	10833051
Matte Black	10833055	Matte Black	10833043

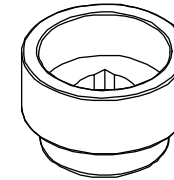

1 3/4" Traditional Swinging Handle Set Kit, Interior Shades

Includes:

- 1 - 3/4" extension handle
- 1 - 2 piece spindle (5 1/16")
- 1 - installation instruction

Color	PN
Satin Taupe	18900650
Antique Brass	18900653
White	18900651
Satin Chrome	18900656
Oil Rubbed Bronze	18900654
Oil Rubbed Bronze PVD	18900655
Brass PVD	18900652
Satin Nickel PVD	18900657
Dark Bronze	18900658
Polished Chrome	18900669
Matte Black	18900688

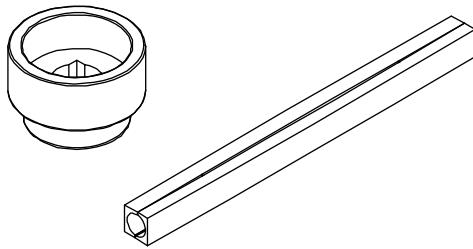

Spindle (Ashland and Truth)

Includes:

- 1 - 2 piece spindle
- 2 - Set screws

NOTE: The 5 1/16" spindle is primarily used for 1 3/4" doors with the 3/4" lever extension.

Size	PN
4 3/8"	18900392
5 1/16"	18900393

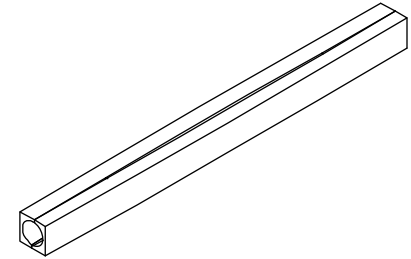

Lug Seals

PN
00142046

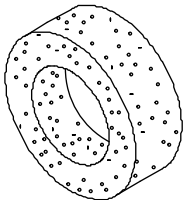

Lever Bushing, Swinging Handle Set, Traditional

Color	PN
Clear	02062201
Gray	10148448
Gold	10148447
Natural	02062202
Black	10148020

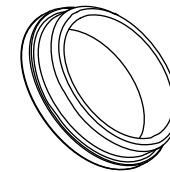

Contemporary Handle, Exterior, Active, Keyed

Includes:

- 1 - Handle
- 1 - Exterior escutcheon with bushing
- 1 - Keyed cylinder
- 2 - Lug seals
- 1 - Spring cartridge
- 1 - Set screw
- 1 - Installation instruction
- 1 - Hex wrench

LH Outswing Panel uses RH PN RH Outswing Panel uses LH PN		
Color	LH PN	RH PN
Matte Black	11870120	11870112
Satin Nickel PVD	11870122	11870114
Oil Rubbed Bronze PVD	11870124	11870116
Dark Bronze	11870126	11870118

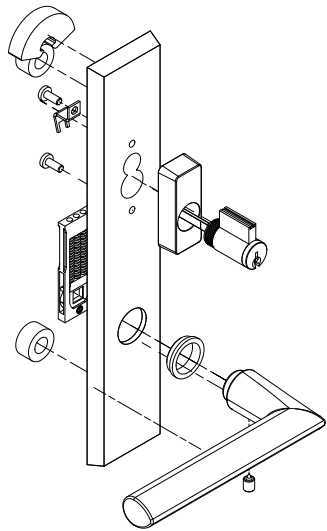

LH shown

Contemporary Handle, Interior, Active, Keyed

Includes:

- 1 - Handle
- 1 - Interior escutcheon with bushings
- 1 - Spring cartridge
- 1 - Thumb turn
- 2 - Machine screws, 2 1/4" Doors
- 2 - Machine screws, 1 3/4" Doors
- 1 - Split spindle, 2 1/4" Doors
- 1 - Split spindle, 1 3/4" Doors
- 1 - Set screw
- 1 - Installation instruction
- 1 - Hex wrench

LH Outswing Panel uses LH PN RH Outswing Panel uses RH PN		
Color	LH PN	RH PN
Matte Black	11870104	11870097
Satin Nickel PVD	11870106	11870098
Oil Rubbed Bronze PVD	11870108	11870100
Dark Bronze	11870110	11870102

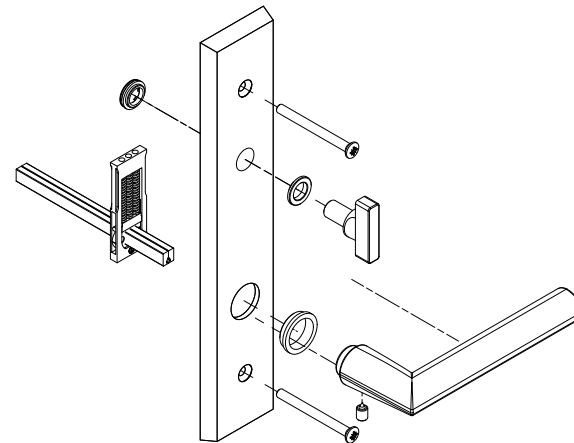

RH shown

Contemporary Handle, Interior, Active, Non-Keyed

Includes:

- 1 - Handle
- 1 - Interior escutcheon with bushings
- 1 - Spring cartridge
- 1 - Thumb turn
- 2 - Machine screws, 2 1/4" Doors
- 2 - Machine screws, 1 3/4" Doors
- 1 - Split spindle, 2 1/4" Doors
- 1 - Split spindle, 1 3/4" Doors
- 1 - Set screw
- 1 - Installation instruction
- 1 - Hex wrench

LH Outswing Panel uses LH PN RH Outswing Panel uses RH PN		
Color	LH PN	RH PN
Matte Black	11870136	11870128
Satin Nickel PVD	11870138	11870130
Oil Rubbed Bronze PVD	11870139	11870132
Dark Bronze	11870143	11870133

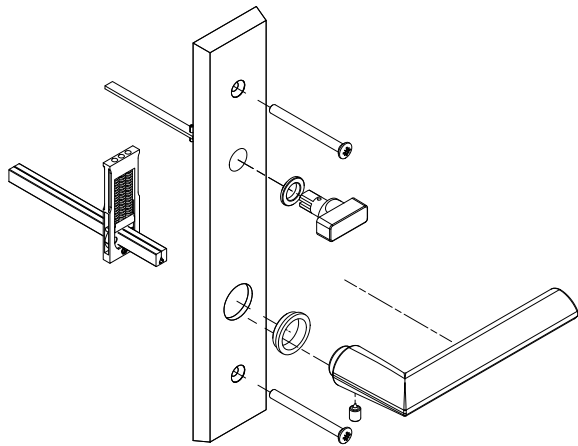

RH shown

Contemporary Handle, Exterior, Non-Keyed, Inactive/Dummy

Includes:

- 1 - Handle
- 1 - Exterior escutcheon with bushings
- 2 - Lug seals
- 1 - Fixing plate
- 1 - Set screw
- 1 - Installation instruction
- 1 - Hex wrench

LH Outswing Panel uses RH PN RH Outswing Panel uses LH PN		
Color	LH PN	RH PN
Matte Black	11870153	11870145
Satin Nickel PVD	11870154	11870146
Oil Rubbed Bronze PVD	11870156	11870148
Dark Bronze	11870158	11870149

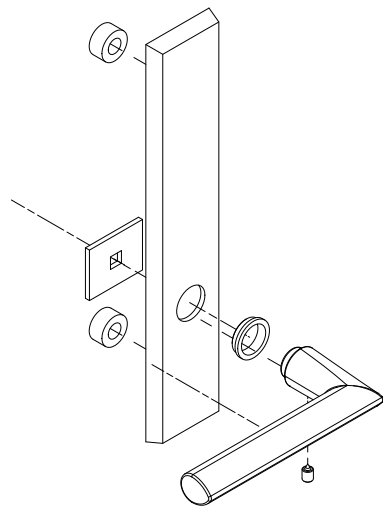

LH shown

Contemporary Handle, Interior, Inactive/Dummy

Includes:

- 1 - Handle
- 1 - Escutcheon with bushing
- 1 - Dummy fixing plate
- 1 - Spring cartridge
- 2 - Machine screws, 2 1/4" Doors
- 2 - Machine screws, 1 3/4" Doors
- 1 - Split spindle, 2 1/4" Doors
- 1 - Split spindle, 1 3/4" Doors
- 1 - Set screw
- 1 - Installation instruction
- 1 - Hex wrench

LH Outswing Panel uses LH PN RH Outswing Panel uses RH PN		
Color	LH PN	RH PN
Matte Black	11870169	11870160
Satin Nickel PVD	11870171	11870162
Oil Rubbed Bronze PVD	11870172	11870164
Dark Bronze	11870174	11870166

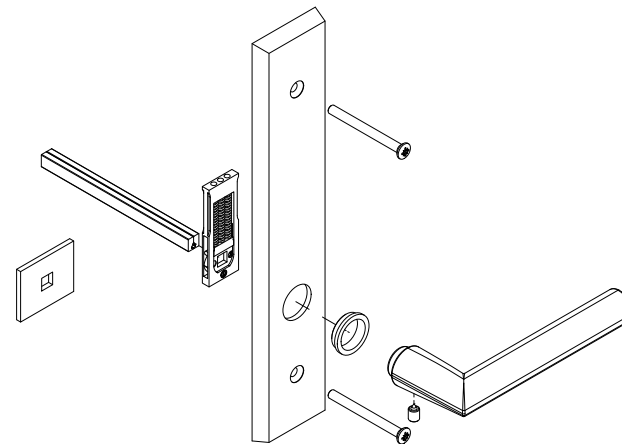

RH shown

Thumb Turn, Contemporary

For Keyed Handle

Includes:

- Thumb Turn Washer
- Thumb Turn Push Nut

No Tail Piece/Actuator (for keyed handle)	
Color	PN
Oil Rubbed Bronze PVD	10148485
Satin Nickel PVD	10148487
Dark Bronze	10148479
Matte Black	10148480

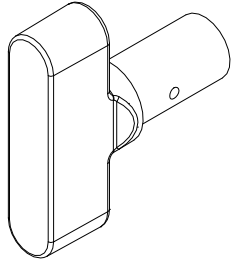

Thumb Turn, Contemporary with Actuator/Tail Piece

For Non-Keyed Handle

Includes:

- Actuator/Tailpiece
- Thumb Turn Washer
- Thumb Turn Push Nut

With Tail Piece/Actuator (for non-keyed handle)	
Color	PN
Oil Rubbed Bronze PVD	10148497
Satin Nickel PVD	10148499
Dark Bronze	10148491
Matte Black	10148492

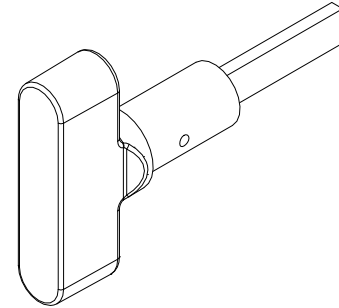

M5 x 55mm Oval Head Machine Screw

Color	PN
Satin Taupe	10148400
Oil Rubbed Bronze PVD	10148402
Satin Nickel PVD	10148403
Dark Bronze	10148404
Matte Black	10148440

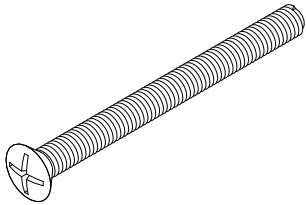

Spindle (Hoppe)

Includes:

- 1 - 2 piece spindle
- 2 - Set screws

Size	PN
4 3/4"	10148414
5 1/2"	10148415

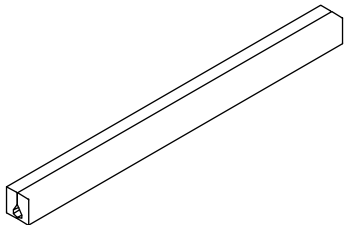

Handle Extension

3/4" Handle Extension (Requires 3/4" Spindle Extension)	
Color	PN
Satin Taupe	10148419
Oil Rubbed Bronze PVD	10148421
Satin Nickel PVD	10148422
Dark Bronze	10148420
Matte Black	10148445

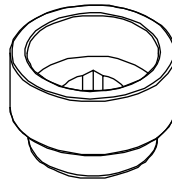

Lever Bushing

Color	PN
Gray	10148448
Natural	02062202
Black	10148020

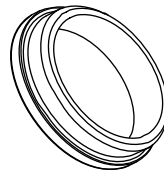

Gasket Post

PN
10148404

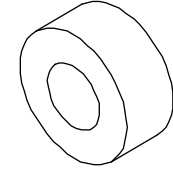

Gasket - Top Backplate

PN
10148405

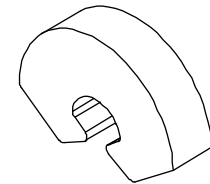

Keyed Cylinder, Lock

(Schlage "C" Keyway)

For service replacement only.

Includes:

2 - Keys

NOTE: For Keyed Alike orders, use program C87P2

Polished Chrome, White, Satin Nickel PVD, Matte Black use
Chrome Face

Satin Taupe, Antique Brass, Satin Chrome, Oil Rubbed
Bronze, Oil Rubbed Bronze PVD, Brass PVD, Dark Bronze
use Brass Face

Color	PN
Brass Face	10830211
Chrome Face	10830208

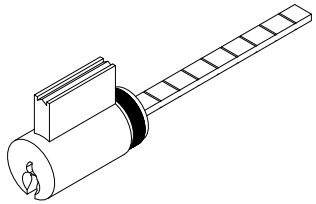

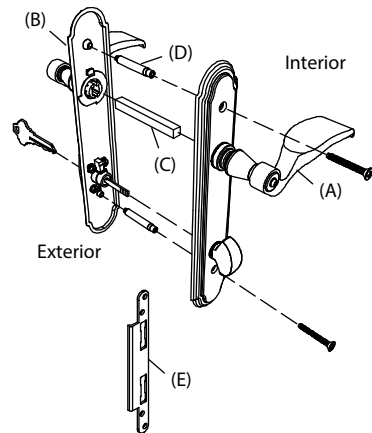

**Multi-Point Handle, Active, Solid Brass -
Pre 2000 (Essve)**

No longer available. Current handle can be used by turning it upside down.

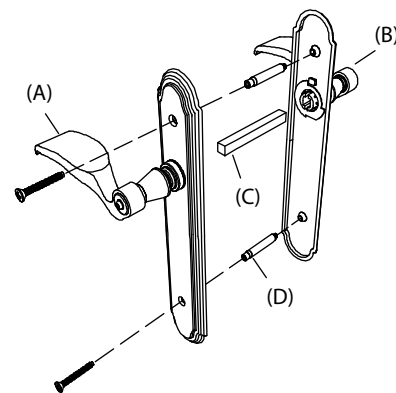

**Multi-Point Handle, Inactive, Solid Brass
- Pre 2000 (Essve)**

No longer available. Current handle can be used by turning it upside down.

Contemporary Handle, Interior, Active, Non-Keyed

Includes:

- 1 - Handle
- 1 - Interior escutcheon with bushings
- 1 - Spring cartridge
- 1 - Thumb turn
- 2 - Machine screws, 2 1/4" Doors
- 2 - Machine screws, 1 3/4" Doors
- 1 - Split spindle, 2 1/4" Doors
- 1 - Split spindle, 1 3/4" Doors
- 1 - Set screw
- 1 - Installation instruction
- 1 - Hex wrench

LH Outswing uses LH PN RH Outswing uses RH PN		
Color	LH PN	RH PN
Matte Black	11870136	11870128
Satin Nickel PVD	11870138	11870130
Oil Rubbed Bronze PVD	11870139	11870132
Dark Bronze	11870143	11870133

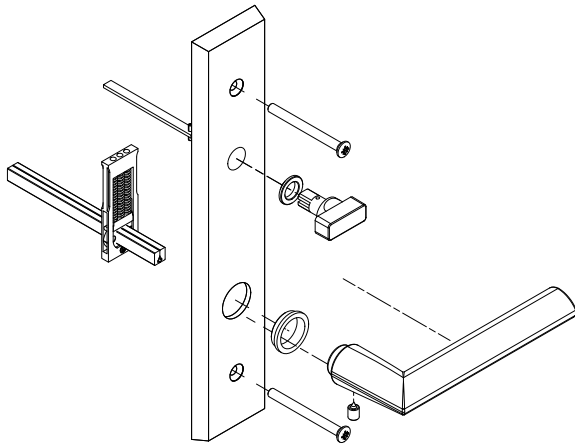

RH shown

Contemporary Handle, Exterior, Non-Keyed, Inactive/Dummy

Includes:

- 1 - Handle
- 1 - Exterior escutcheon with bushings
- 2 - Lug seals
- 1 - Fixing plate
- 1 - Set screw
- 1 - Installation instruction
- 1 - Hex wrench

LH Outswing uses RH PN RH Outswing uses LH PN		
Color	LH PN	RH PN
Matte Black	11870153	11870145
Satin Nickel PVD	11870154	11870146
Oil Rubbed Bronze PVD	11870156	11870148
Dark Bronze	11870158	11870149

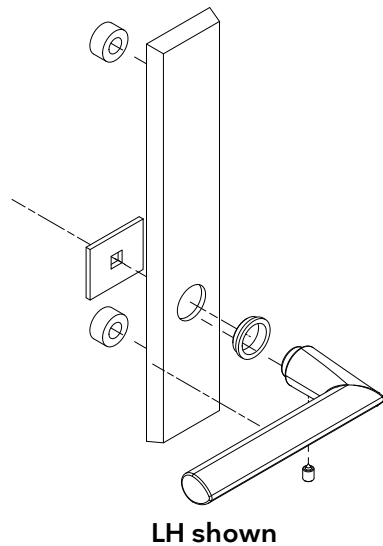

Contemporary Handle, Interior, Inactive/Dummy

Includes:

- 1 - Handle
- 1 - Escutcheon with bushing
- 1 - Dummy fixing plate
- 1 - Spring cartridge
- 2 - Machine screws, 2 1/4" Doors
- 2 - Machine screws, 1 3/4" Doors
- 1 - Split spindle, 2 1/4" Doors
- 1 - Split spindle, 1 3/4" Doors
- 1 - Set screw
- 1 - Installation instruction
- 1 - Hex wrench

LH Outswing uses LH PN RH Outswing uses RH PN		
Color	LH PN	RH PN
Matte Black	11870169	11870160
Satin Nickel PVD	11870171	11870162
Oil Rubbed Bronze PVD	11870172	11870164
Dark Bronze	11870174	11870166

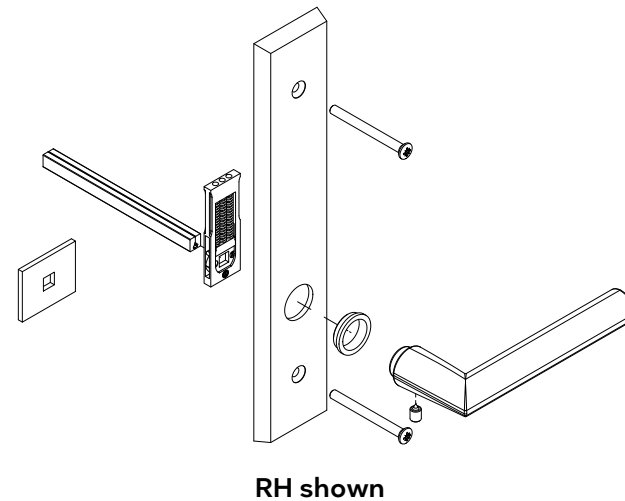

M5 x 55mm Oval Head Machine Screw

Color	PN
Satin Taupe	10148400
Oil Rubbed Bronze PVD	10148402
Satin Nickel PVD	10148403
Dark Bronze	10148404
Matte Black	10148440

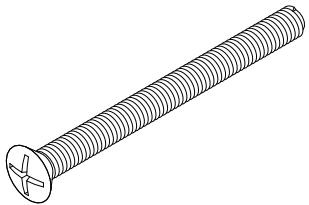

Spindle (Hoppe)

Includes:

- 1 - 2 piece spindle
- 2 - Set screws

Size	PN
4 3/4"	10148414
5 1/2"	10148415

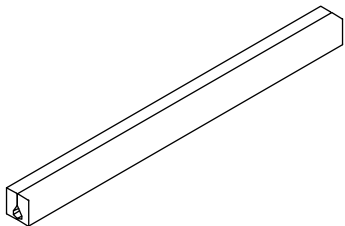

Handle Extension

3/4" Handle Extension (Requires 3/4" Spindle Extension)	
Color	PN
Satin Taupe	10148419
Oil Rubbed Bronze PVD	10148421
Satin Nickel PVD	10148422
Dark Bronze	10148420
Matte Black	10148445

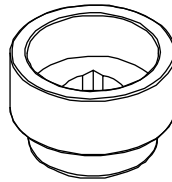

Lever Bushing

Color	PN
Gray	10148448
Natural	02062202
Black	10148020

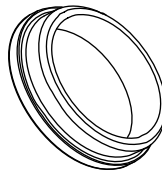

Gasket Post

PN
10148404

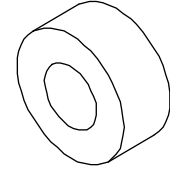

Gasket - Top Backplate

PN
10148405

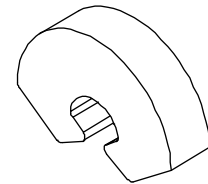

**NOTE: Always view units
from the exterior for handing.
H=Hinge location**

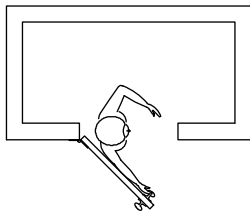

RH Outswing

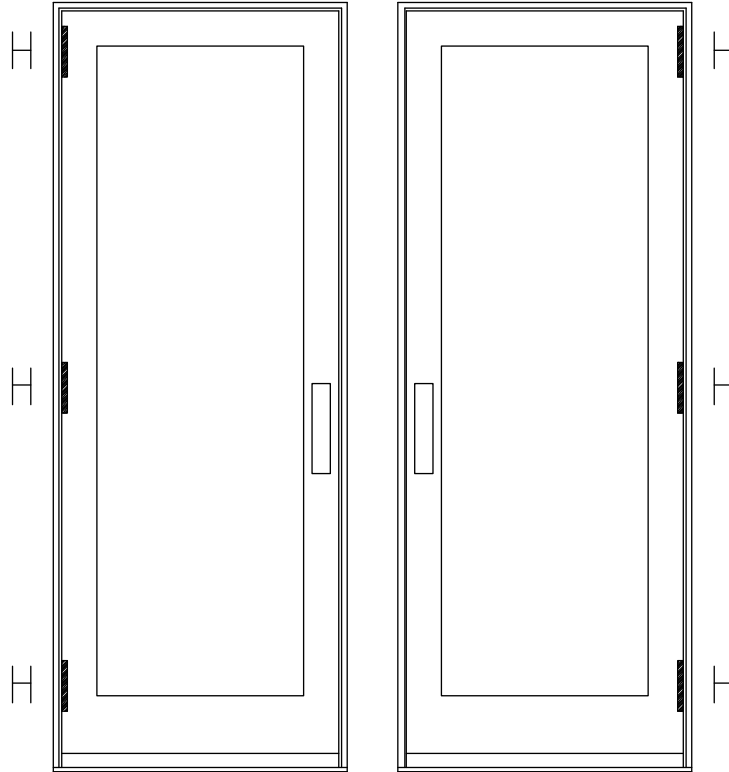

X-RH Outswing
This panel uses the
right hand hinge

X-LH Outswing
This panel uses the
left hand hinge

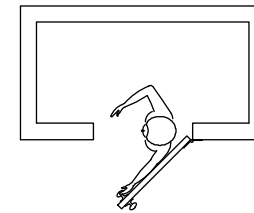

LH Outswing

4" Butt Hinge

NRP=Non Removable Pin

Includes:

- 1 - 4" Hinge
- 7 - #9 x 1" Phillips flat head wood screws - a
- 1 - #10 x 2 1/2" Phillips flat head wood screw (frame) b

Hinge Color	PN
Brass	02101140
Satin Nickel PVD	02100599
Stainless Steel	11809005

Screw Color - b	PN
#9 x 1" Brass	11213824
#10 x 2 1/2" BS PVD	11800679

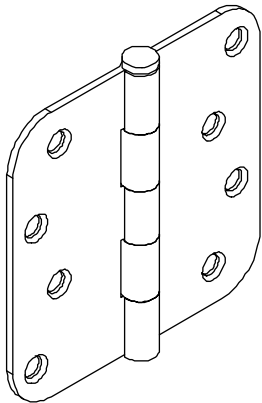

4" Butt Hinge Shim

PN
10500222

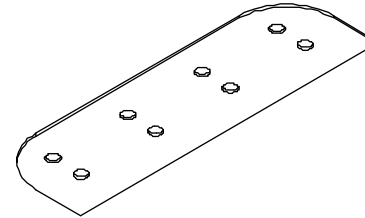

Long Hinge Screw Package

Includes:

- 4 - #10 x 2 1/2" screws
- 1 - 5/32" Allen wrench

Hinge Color	PN
Satin Taupe	11800653
Gold Tone	11800632
Dark Bronze	11800644
White	11800637
Stainless Steel	11800639
Brass PVD	10148185
Matte Black	11800696

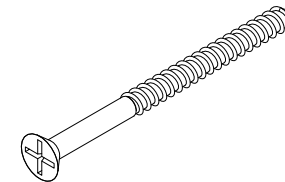

NOTE: Order Dark Bronze screw package for Dark Bronze, Antique Brass and Oil Rubbed Bronze hinges. Order Stainless Steel screw packages for Silver Frost, Satin Chrome and Satin Nickel PVD hinges.

Hinge Kit, Adjustable

Includes:

- 1 - Adjustable hinge
- 1 - #10 x 2 1/2" Phillips flat head wood screws (jamb)
- 5 - #10 x 3/4" Phillips flat head wood screws (jamb, stationary stile)
- 4 - #8 x 1 1/2" Phillips flat head wood screws (panel)

NOTE: Hinge part number includes the color matched screws, If you need to order the screws separately, they are listed below.

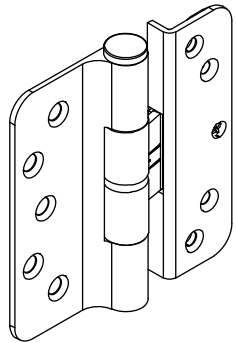

LH Hinge

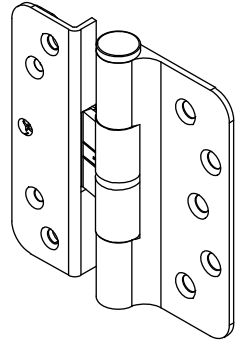

RH Hinge

Hinge Color	LH PN	RH PN
Satin Taupe (TP)	02101216	02101227
Goldtone (GT)	02101213	02101224
Silver Frost (SF)	02101218	02101229
Dark Bronze (DKBZ)	02101217	02101228
Antique Brass (AB)	02101210	02101221
White (WH)	02101214	02101225
Satin Chrome (SC)	02101212	02101223
Oil Rubbed Bronze (ORBZ)	02101219	02101230
Oil Rubbed Bronze PVD (ORBZ)	02101211	02101222
Brass PVD (BS)	02101215	02101226
Satin Nickel (SN) PVD	02101220	02101231
Polished Chrome (PC)	02101234	02101235
Matte Black (MBK)	02101236	02101237

Screw Color	Matching Hinge Color
TP	TP
GT	GT
WH	WH
DKBZ	AB, ORBZ PVD, DKBZ, ORBZ
BS PVD	BS PVD
Stainless Steel	SC, SF, SN PVD, PC
Chrome	SC, SF, SN PVD, PC
MBK	MBK

Screw Description	TP PN	GT PN	WH PN	DKBZ PN	BS PVD PN	Stainless Steel PN	Chrome PN	MBK PN
#8 x 1 1/2" Phillips flat head wood screws (panel). Quantity of four needed per hinge.	11865177	11865172	11865173	02058013	11865176	11865175		11865178
#10 x 3/4" Phillips flat head wood screws (jamb) (stationary stile). Quantity of five needed per hinge.	11800674	11800670	11800671	11800669	11800673		11800672	11800677
#10 x 2 1/2" Phillips flat head wood screws (jamb). Quantity of one needed per hinge.	11800653	11800632	11800637	11800644	10148185	11800639		11800696

NOTE: Part numbers for these screws are sold in packages of 4 screws and includes 1 - 5/32" Allen wrench.

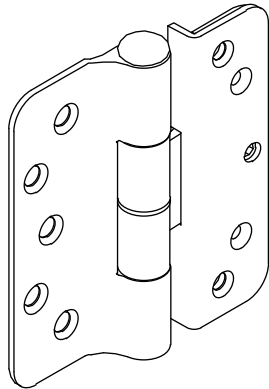

Hinge, Adjustable, Pre 2012

No longer available.

NOTE: The current adjustable hinge kit may be used. If using the current hinge, all hinges on the panel must be changed.

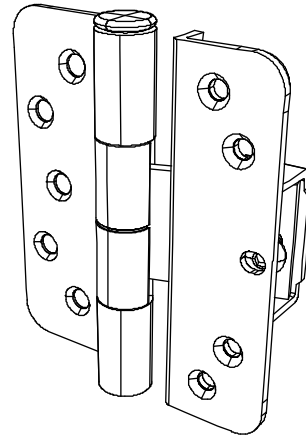

Hinge, Adjustable, 2000-2005

No longer available.

NOTE: The current adjustable hinge kit may be used. If using the current hinge, all hinges on the panel must be changed.

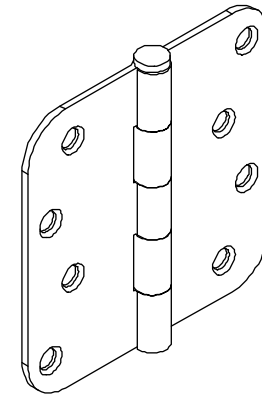

Butt Hinge, Outswing Doors (RP version shown)

No longer available.

Screw Description		
Available fasteners: #10 x 1" Phillips flat head wood screws. Quantity of 5 needed per hinge		
Hinge Color	Screw Color	PN
Satin Taupe	Satin Taupe	05580145
Goldtone	Goldtone	11800606
Satin Frost	Stainless Steel	11800605
Dark Bronze	Dark Bronze	02050526
Antique Brass	Dark Bronze	02050526
White	White	11800603
Satin Chrome	Stainless Steel	11800605
Oil Rubbed Bronze	Dark Bronze	02050526
Oil Rubbed Bronze PVD	Dark Bronze	02050526
Brass PVD	Brass PVD	11800600
Satin Nickel PVD	Stainless Steel	11800605
Polished Chrome	Stainless Steel	11800605

Pkg, Panel Strike Plate

Mortise Lock or Multi-Point Lock

Includes:

- 1 - Panel strike plate, Stainless Steel (05700049), Antique Brass (05700044), Oil Rubbed Bronze PVD (05700117) and Brass PVD (10148176)
- 2 - #8-18 x 1" Type AB, Full thread, Phillips flat head screws, Stainless Steel (11800645), Dark Bronze (11800652) and Brass PVD (11800536)

Note: Dark Bronze screws are used with Antique Brass and Oil Rubbed Bronze PVD

Color	PN
Stainless Steel	05700312
Antique Brass	05700313
Oil Rubbed Bronze PVD	05700314
Brass PVD	10148183

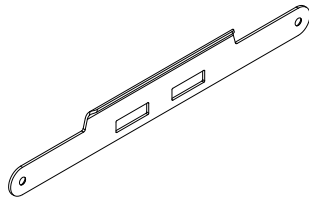

Cover Plate

Active Mortise Lock or Multi-Point Lock

Includes:

- 1 - Cover plate
- 2 - #8-18 x 1" Type AB, Full thread, Phillips flat head screws, Stainless Steel (11800645), Dark Bronze (11800652) and Brass PVD (11800536)

Note: Dark Bronze screws are used with Antique Brass and Oil Rubbed Bronze PVD

Color	PN
Stainless Steel	05700306
Antique Brass	05700307
Oil Rubbed Bronze PVD	05700308
Brass PVD	10148179

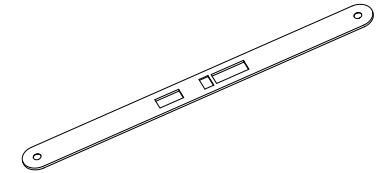

Strike Plate, Jamb

Mortise Lock or Multi-Point Lock

Std on 1 panel operator

Includes:

- 1 - Jamb strike plate
- 2 - #8-18 x 1" Type AB, Full thread, Phillips flat head screws, Stainless Steel (11800645), Dark Bronze (11800652) and Brass PVD (11800536)

Note: Dark Bronze screws are used with Antique Brass and Oil Rubbed Bronze PVD

Color	PN
Stainless Steel	05700309
Antique Brass	05700310
Oil Rubbed Bronze PVD	05700311
Brass PVD	10148182

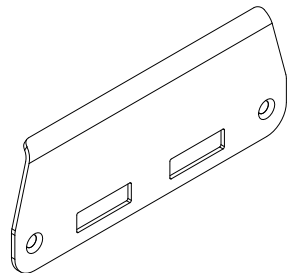

Mortise Lock, Active Multi-Point Lock

(latch, dead bolt and head/foot shoot bolts)

PN
05700130

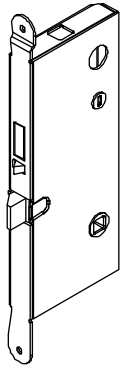

Mortise Lock, Inactive Panel Multi-Point Lock

(head/foot shoot bolts)

PN
05700131

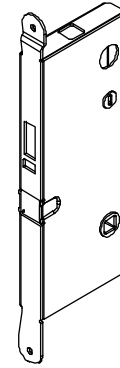

Mortise Lock, Active Single Point

(latch and dead bolt only)

PN
05700129

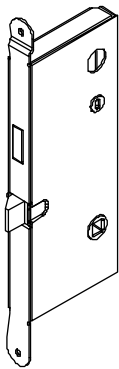

Head or Foot Flush Bolt - Inactive Panel

Color	PN
Black	11101780

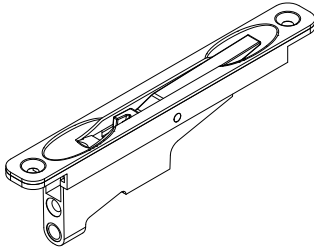

Cover Plate for Flush Bolt

Includes:

- 1 - Cover plate
- 2 - #8 x 1" screws

Color	PN
Aluminum	11860402

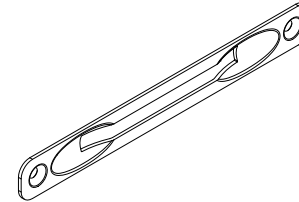

Shoot Bolt Guide

Active Panels - with Multi-Point
Inactive Panels - All

PN
10815199

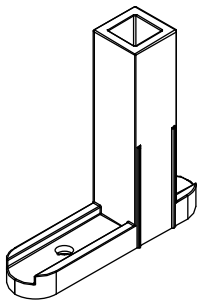

Strike Plate, Head Jamb

Includes:

- 1 - Strike plate
- 2 - #8 x 1" Phillips truss head screws (head jamb)
- 2 - #8 x 3" truss head stainless screws (head jamb)

Color	PN
Beige	05700315
Bronze	05700316

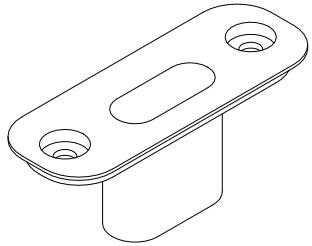

Strike, Sill

Includes:

- 1 - Strike plate
- 2 - #8 x 5/8" Phillips truss head stainless steel machine screws (sill)
- 2 - Well-nut threaded insert (sill)

Color	PN
Beige	18900365
Bronze	18900368

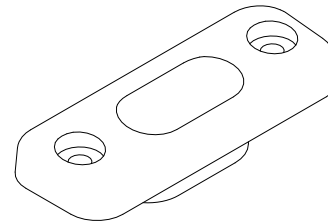

#10 x 3" Phillips Flat Head Screws

For Head Jamb Strike Plate at installation.

Color	PN
Stainless Steel	02056011

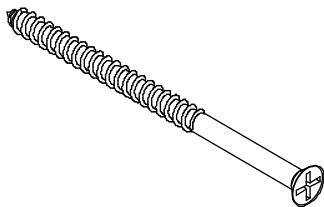

Inactive Panel Locking Rod Assembly, Top or Bottom Flush Bolt

Includes:

1 - Locking rod with end bolt

CN Height	Top Locking Rod Length	Color	PN
6/8	11"	Stainless Steel	05700180
7/0	11"		05700180
8/0	27"		05700185
9/0	34 1/4"		05700170
Height	Btm Locking Rod Length		PN
All heights	11 1/2"		10815178

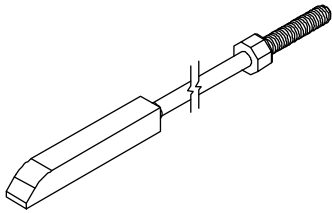

Locking Rod Assembly, Top for Multi-Point Lock

Solid stainless steel rod with 1/4" - 20 threads
Active Panels with multi-point

Usage date:

3/02 to present (Amerock) 8-0 height see History
5/10/90 to present (Amerock) 6-8 and 7-0 height

CN Height	Top Locking Rod Length	PN
6/8	37 15/16"	05700176
7/0	41 15/16"	05700177
8/0	51 7/16"	05700179
9/0	63 7/16"	05700191

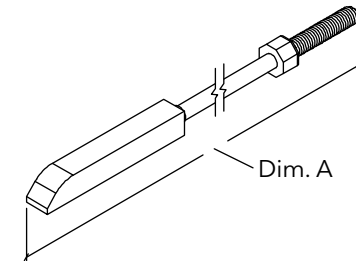

Locking Rod Assembly, Bottom for Multi-Point Lock

Active Panels with Multi-Point
Solid stainless steel rod with 1/4" - 20 threads

Height	Btm Locking Rod Length	Color	PN
CN 6/8 ht	34 3/4"	Stainless Steel	10815179
CN 7/0 ht			
CN 8/0 ht			
CN 9/0 ht			

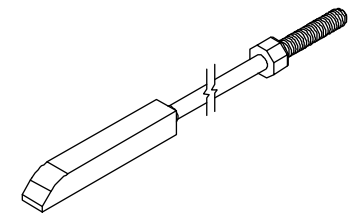

Jamb Spacer Tack, Stationary Panel

3/4" Diameter Head

PN
11860423

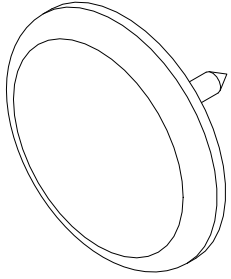

Head Jamb Spacer Tack, Stationary Panel

PN
11860424

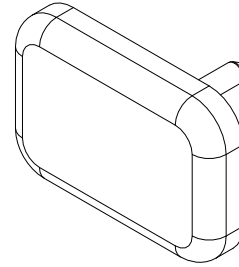

Sill Bolt, Stationary Panel

Includes:

2 - #8 x 3" Phillips flat head wood screws (11800830)

Color	PN
Zinc Die Cast	11101856

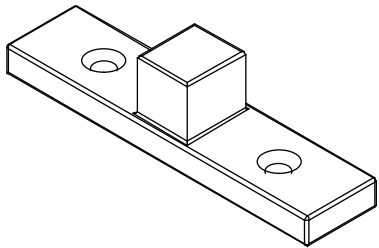

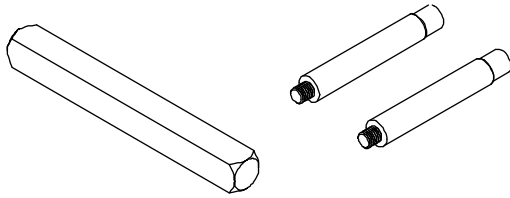

**Spindle Package for Multi-Point Handle
(Essve) - Pre 2000**
No Longer Available

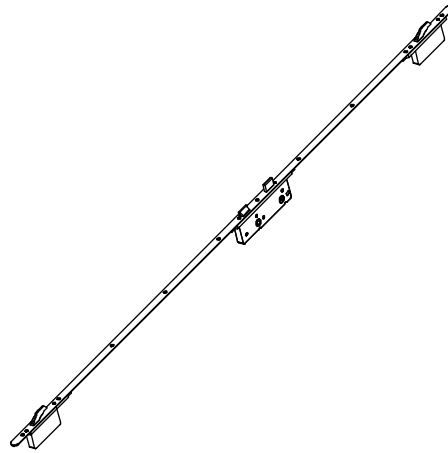

**Active Multi-Point Hardware Assembly
(Essve) - Pre 2000**
No Longer Available

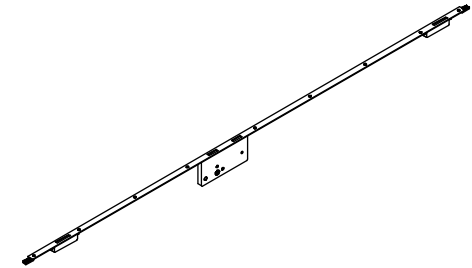

**Inactive Multi-Point Hardware Assembly
(Essve) - Pre 2000**
No Longer Available

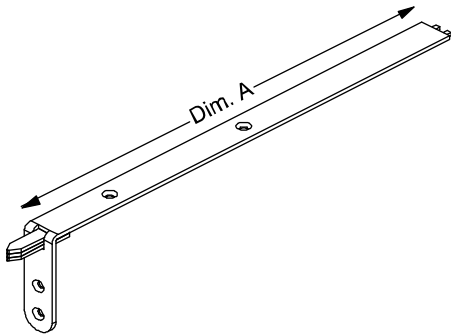

**Multi-Point Top Corner Drive (Essve)
Pre 2000**
No Longer Available

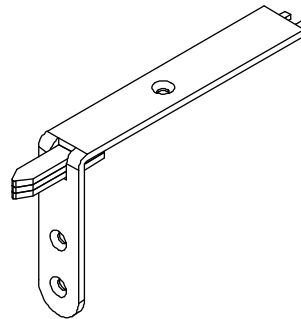

**Multi-Point Bottom Corner Drive (Essve)
Pre 2000**
No Longer Available

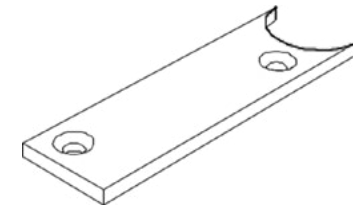

**Corner Drive Filler, Multi-Point Lock (Essve)
Pre 2000**
No Longer Available

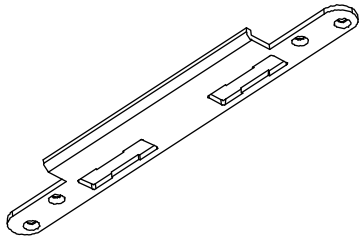

Jamb Strike, Center, Solid Brass; Multi-Point Lock (Essve) - Pre 2000
No longer available.

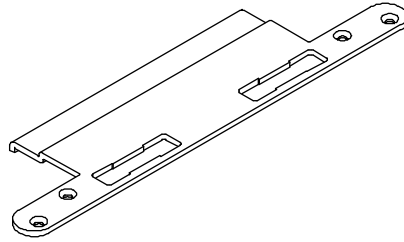

Jamb Strike, Center, Extended, Solid Brass; Multi-Point Lock (Essve) - Pre 2000
No longer available.

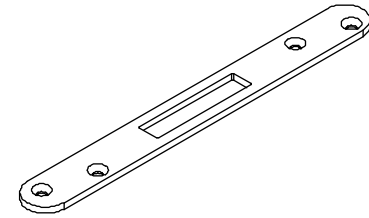

Jamb Strike, Top or Bottom, Solid Brass; Multi-Point Lock (Essve) - Pre 2000
No longer available.

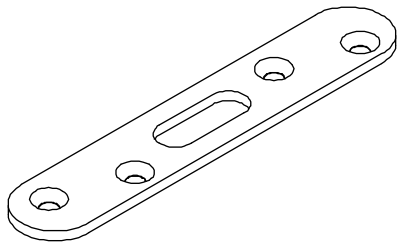

Strike, Inactive Panel, Head Jamb; Multi-Point Lock (Essve) - Pre 2000
No longer available.

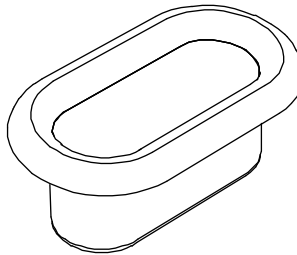

Corner Drive Sill Receptacle, Solid Brass; Multi-Point Lock (Essve) - Pre 2000
No longer available.

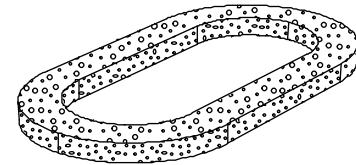

Sill Receptacle Gasket; Multi-Point Lock
No longer available.

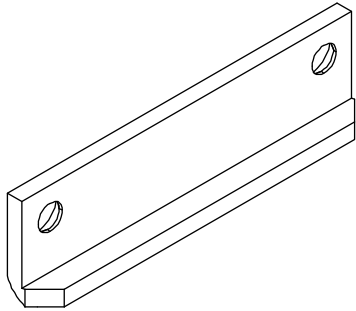

Astragal Strike Latch; Multi-Point Lock (Essve) - Pre 2000
No longer available.

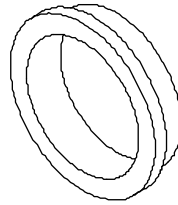

Lever Washers Pre 2000
No longer available.

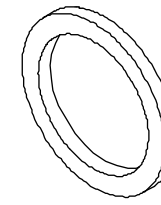

Lever Spacers Pre 2000
No longer available.

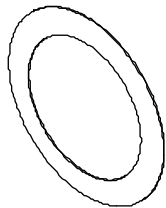

Lever Shims Pre 2000
No longer available.

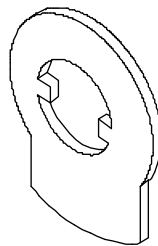

Dummy Lever Cams Pre 2000
No longer available.

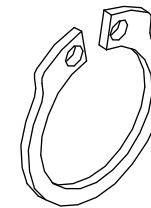

Snap Rings Pre 2000
No longer available.

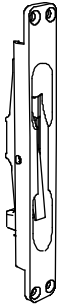

Inactive Panel Flush Bolt - 9/25/00 - 3/02
No longer available.

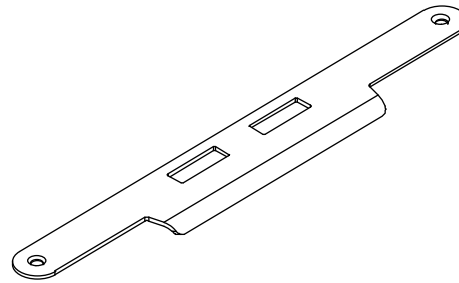

Strike Plate, Panel - Mortise Lock or Multi-Point Lock 9/25/00 to 3/31/03 (Amerock)
No longer available.

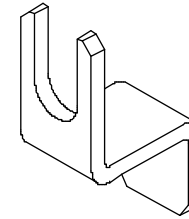

Stop clip with screws 9/25/00 to Present
No longer available as individual part -

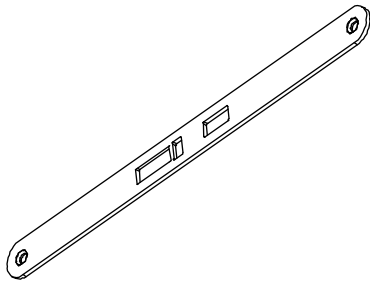

Cover Plate, Active Panel - Mortise Lock or Multi-Point Lock 1/17/00 to 3/31/03 (Amerock)
No longer available.

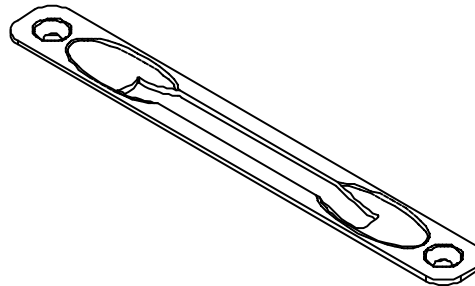

Cover Plate for Flush Bolt
No longer available.

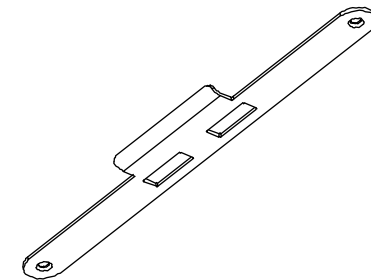

Strike Plate, Inactive Panel - Mortise Lock or Multi-Point Lock - 9/25/00 - 3/31/03 (Amerock)
No longer available.

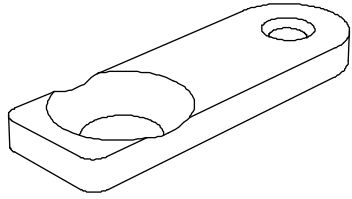

**Inactive Panel Backset Extension - Head or
Foot Flush Bolt - 9/25/00 to Present**

No longer available.

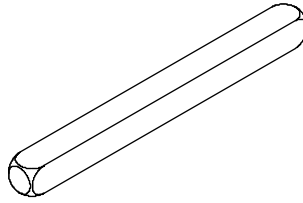

Spindle 4 3/16" - Pre 2000

No longer available.

When ordering replacement parts, specify:

1. Profile number;
2. size (call number or rough opening);
3. length;
4. handing;
5. finish.

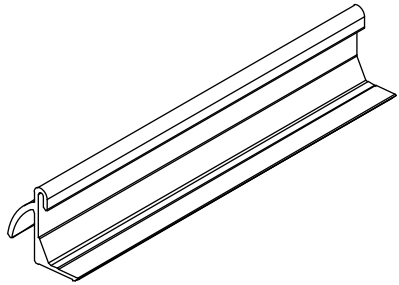

Hydro-Optimizer, A1251

Beige or Bronze

When ordering replacement parts, specify:

1. Profile number;
2. call number or rough opening;
3. length
4. LH or RH operation;
5. type of product
6. finish.

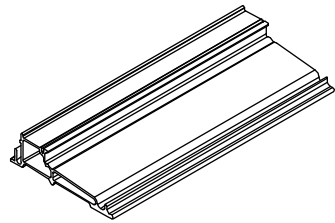

Ultrex Sill 4 9/16 Jamb, F256
Beige or Bronze

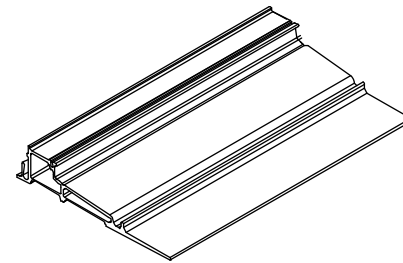

Ultrex Sill 6 9/16 Jambs, F257
Beige or Bronze

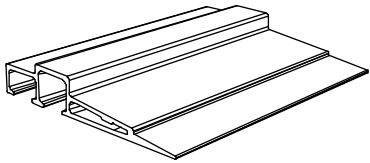

Ultrex Sill - Pre 2000, F252
No longer available

Connecting Barb

V803

NOTE: Color may vary depending on current stock.

Wood Door and Wood Transom only

Length	PN
Specify Length	15812999

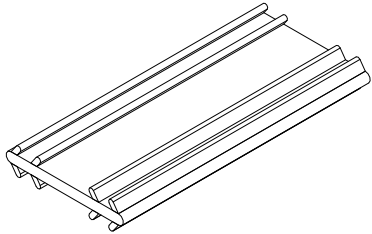

When ordering replacement parts, specify:

1. Original order/line number;
2. profile number;
3. rough opening;
4. handing;
 - a. on jamb parting stop specify right or left jamb (viewed from exterior)
5. length;
6. finish.

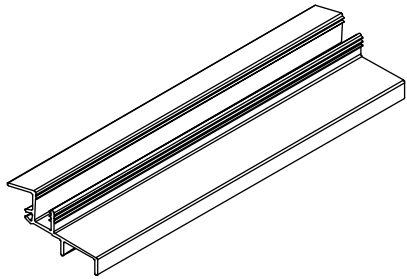

Stationary Panel Drip/Sill Spacer, V941

Beige or Black

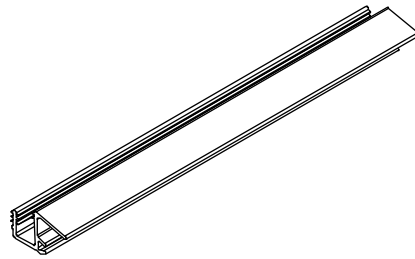

Panel Drip, V940

Beige or Black

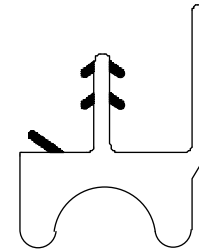

Panel Drip (In-Sash Transom), V800

Beige or Black

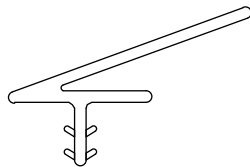

Sash Retainer (Transom), V026

Beige or Black

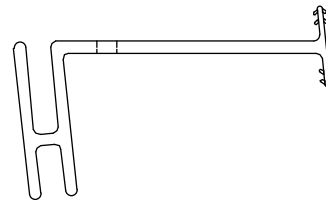

Sill Leveling Block (Transom), V027

Beige or Black

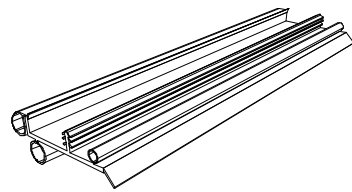

Sweep, V212
No longer available

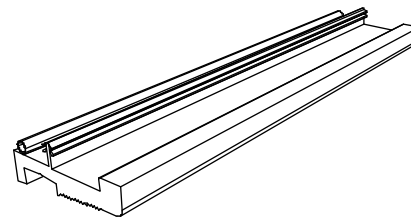

Stationary and Sidelite Leveling Block, V770
No longer available

When ordering replacement parts, specify:

1. Profile number;
2. rough opening;
3. handing;
4. length
5. finish.

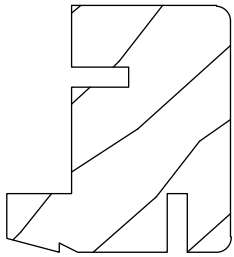

Jamb Stop, W6531

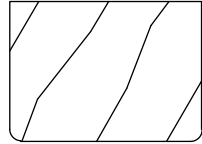

Head Jamb Stop, W8598

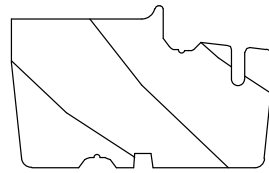

First Mull Casing and Astragal, W1455

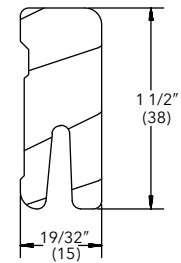

Sill Liner (oak), W2528

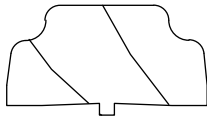

Astragal Cover, W7554

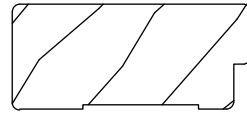

Stationary Sweep Filler, W3297

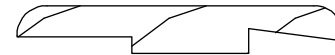

Oak Sill Cover, W9510

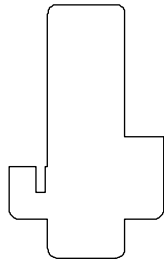

Astragal, W7222
No longer available

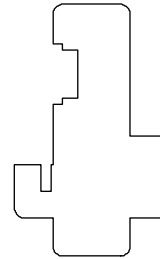

Astragal (Multi-Point), W7219
No longer available

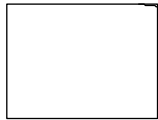

Stationary Head Jamb, Jamb and Astragal Filler, W6040
No longer available



Stationary Head Jamb and Jamb Spacer, W6220
No longer available

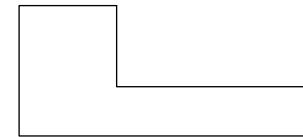

Stationary Jamb Filler (Multi-panel), W7235
No longer available

Weather Strip, Sill

V776

Length	Beige PN	Black PN
87 11/16"	11197276	NA
164 7/8"	11197296	11197297
164 7/8"	11197297	NA

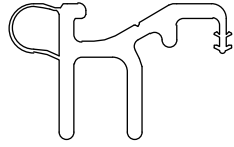

Weather Strip, Stile

V020

Length	Beige PN	Black PN
79 7/16"	11197968	11197969
83 7/16"	11197970	11197982
92 15/16"	11197982	11197981
95 9/16"	11197980	NA
104 15/16"	11197990	11197991
150"	11197999	11197998

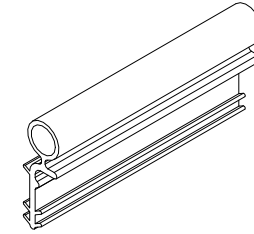

Weather Strip, Panel Cover

V018

Length	Beige PN	Black PN
150"	11198799	11198999

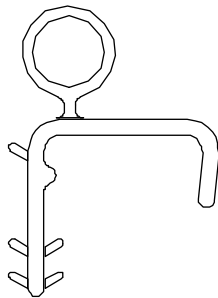

Offset Bulb Weather Strip

V796

Used at: Parting Stop, Frame, Mull Casing, Transom and Astragal

Length	Color	PN
75 43/64"	Beige	15170866
	Black	15170867
104 7/8"	Beige	15170090
	Black	15170091
115 41/64"	Beige	15170810
	Black	15170811
189 11/16"	Beige	15173298
	Black	15173398

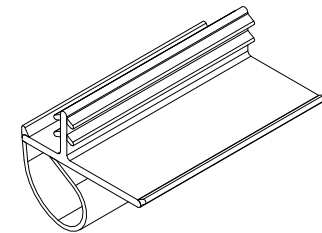

Weather Strip, Frame

V017

Length	Beige PN	Black PN
41 5/16"	11197536	NA
80 5/8"	11198668	NA
94 1/8"	11198682	NA
164 7/8"	11197596	11197598
164 5/32"	11197596	NA
164 7/8"	11197596	11197598



Pile Weather Strip, Jamb or Panel

1 3/8" x 3/8" x 1/2"

Adhesive backed

Color	PN
Gray	15600010

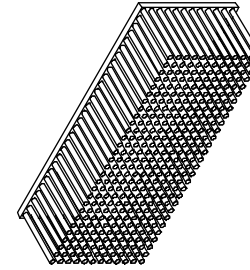

Sweep, Active and Inactive Panel

V779

Length	Beige PN	Black PN
CN 2/6	11197426	NA
CN2/8	11197428	NA
CN 3/0	11197430	11197431

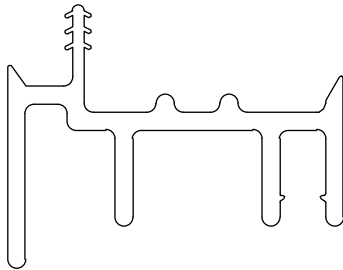

Sweep, Stationary Panel

V778

Length	Beige PN	Black PN
CN 3/0	11197330	NA
150"	11197399	11197398

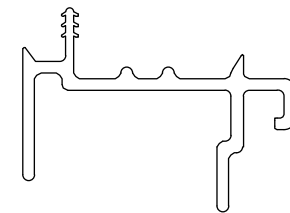

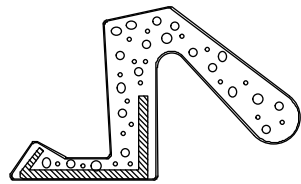

Foam Weather Strip, Frame V650
No longer available.

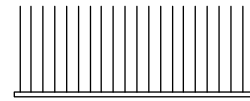

Pile Weather Strip, Sill
No longer available.

When ordering replacement panels, specify:

NOTE: Weather strip is included with all panels (where applicable).

1. OM of panel (NOTE: OM of panel does not include astragal, mull casing);
 - a. template required for Ultimate Arch Top French door panel prior to 7/14/03.
2. Active, Inactive or Stationary;
 - a. Active - specify no lock (no bore), bore for passage latch/dead bolt, single-point mortise lock or multi-point lock.
 - b. Inactive - specify head or foot bolts or multi-point lock.
 - c. Stationary - specify configuration and/or mull casing (if applicable).
3. Handing;
4. Glazing;
5. Finish;
6. Glazing bead profile
 - a. bevel
 - b. square.
 - Active panels include sweep and route for hinges
 - Inactive panels include sweep, route for hinges, astragal and head and foot bolts
 - Stationary panels include leveling block



When ordering replacement parts, specify:

1. Original order/line number;
2. profile number;
3. length;
4. handing;
 - a. on jamb filler specify right or left jamb (viewed from exterior)
5. finish.

Usage date:

5/98 to Present

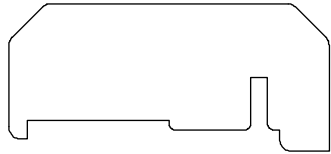

Astragal, W7528



Stationary Panel Head Jamb Spacer, W6126

When ordering replacement parts, specify:

1. Original order/line number;
2. profile number;
3. length;
4. handing;
 - a. on jamb filler specify right or left jamb (viewed from exterior)
5. finish.

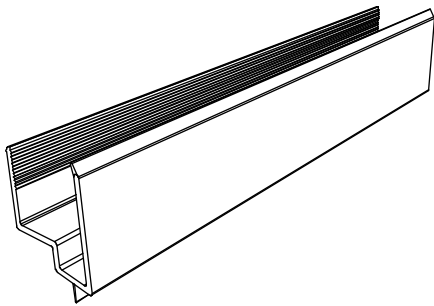

V200 Bottom Rail Filler
Ultimate Doors from 5/98

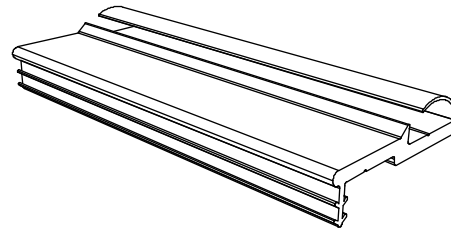

V822 Astragal Base/Weather Strip - Beige

Thimble

Head Bolt Receiver

Color	PN
Brass	02540664

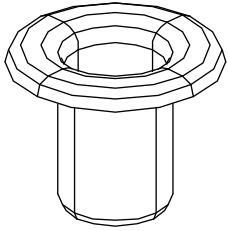

Head or Foot Bolt, Solid Brass

Includes:

1 - Bolt Assembly

PN
00143068

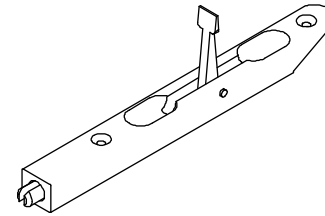

6 9/16" Sill Strike

Foot Bolt receiver - specify prep for combination

Color	PN
Beige	05700031

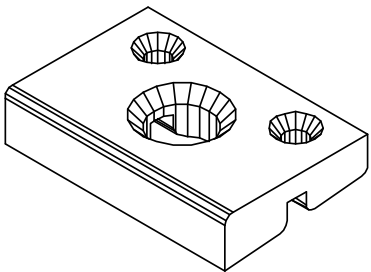

Stationary Panel Bracket

Includes:

1 - Stationary panel bracket

4 - #7 x 3/4" Phillips flat head wood screws

PN
11841000

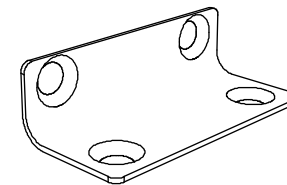

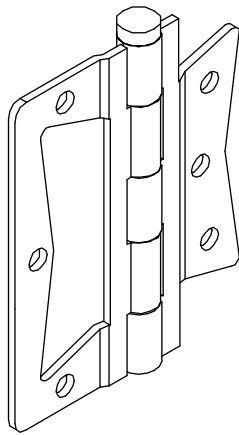

Surface Mount Hinge Pair, Solid Brass
No longer available

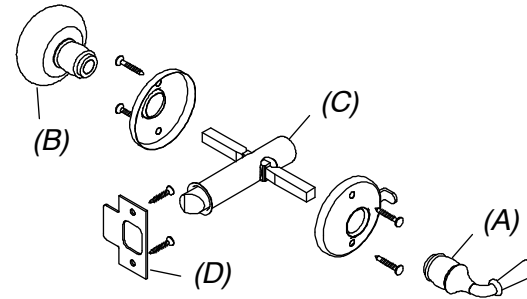

Handle Set, Solid Brass
No longer available