



Essential Double Hung

Replacement Parts

Specifications and technical data are subject to change without notice.

Numbers listed in () parentheses are metric equivalents in millimeters rounded to the nearest whole number.

Suggested fasteners are not included and must be ordered separately.

Illustrations are not to scale.

Contents

Product History.....	2
Part Identification - Operator.....	3
Part Identification - Stationary/Picture	4
Locking Hardware	5
Locking Hardware - Discontinued No Availability (NA)	6
Miscellaneous Parts	7
Miscellaneous Parts - Discontinued Limited Availability (LA)	10
Miscellaneous Parts - Discontinued No Availability (NA).....	11
Balance Tube Replacement	12
Balance Tubes	13
WOCD Field Applied and Replacement Kit	18
Vinyl Parts.....	19
Vinyl Parts - Discontinued Limited Availability (LA).....	24
Vinyl Parts - Discontinued No Availability (NA).....	25
Weather Strip - Configured Parts in OMS	26
Weather Strip	27
Weather Strip - Discontinued Limited Availability (LA).....	29
Weather Strip - Discontinued No Availability (NA).....	30
Sash Replacement.....	31
Screen Replacement.....	32
Screen Parts	33
Screen Parts - Discontinued Limited Availability (LA).....	34
Screen Parts - Discontinued No Availability (NA)	35
Sash, Frame and Screen DLO charts - Equal Sash Units	36
Sash, Frame and Screen DLO charts - Cottage Units	37
Sash, Frame, Screen and DLO Charts - Reverse Cottage Units.....	38

Produced	Unit Type	Features and Changes
2007	Double Hung	03/2007: Unit features 3/4" double strength insulating Low E II w/argon. GBGs are available in White, Pebble Gray and Bronze. 2" jambs with a 4 9/16" and 6 9/16" extensions. Available with factory applied sheet rock return and field applied J-channel. White interior only with white hardware. Pebble Gray, Stone White and Bronze exteriors. 11/2007: Evergreen exteriors added. V1143 and V1152 frame weather strip changed from gray to beige. V1472 leveling block changed to V1562.
2008	Double Hung	03/17/2008: Cashmere exteriors introduced. 10/2008: CN28 introduced.
2009	Double Hung	03/2009: Ebony exteriors introduced. 05/2009: LoE3 366 glass option introduced.
2010	Double Hung	02/2010: Introduced new hardware finishes: Oil Rubbed Bronze (ORBZ), Satin Nickel PVD (SN) and Brass PVD (BS)
2011	Double Hung	08/2011: Sill weather strip V1992 replaced with V2099.
2012	Double Hung	4/30/2012: Now available with the unequal sash option. 10/29/2012: Introduced Expanded Sizes and Mulls.
2013	Double Hung	08/26/2013: Added new cam lock and keeper and forced entry clip. 10/28/2013: Discontinued the optional vent stop option for limiting sash travel and venting. Added Window Opening Control Device (WOCD); offers sash limits and venting option. Bottom sash tilt latch was slightly modified and works on all units manufactured from 9-2006 to present.
2015	Double Hung	02/23/2015: Introduced a new drip cap with nailing fin.
2017	Double Hung	02/27/2017: Implemented redesign to Essential Sliding Windows.
2017	Double Hung	12/18/2017: Added availability of customer specified divided lite cut configurations for GBG. Also, includes allowing any color GBG to the exterior only of standard and special sized units.
2018	Double Hung	02/2018: Introduced Bronze and Ebony interior option. Standardized Ebony exterior from Essential Ebony to Marvin Ebony. 10/29/2018: Low E3 ERS glass type was added. 12/17/2018: Introduced textured glass types: Reed, Narrow Reed, Rain, Glue Chip and Frost and also colored glass types: Clear, Bronze, Gray and Green.
2019	Double Hung	01/28/2019: Screen frame was updated.
2020	Double Hung	01/2020: Protective Glass Film becomes a standard feature across all Essential product lines. 04/27/2020: Added WOCD Field applied and replacement kits (See Product Bulletin 758).
2021	Double Hung	10/25/2021: Standard screen mesh changed to Marvin Bright View™. See product bulletin 793 for more information.
2022	Double Hung	06/27/2022: The Essential collection will transition to black weatherstrip (and associated components) for all window and door products, effective June 27th, 2022. Beige weather strip will continue to be available for warranty/service needs. See Product Bulletin 834 for more information. Frame weather strip (V1573/V2881) were added to Configured Parts in OMS. See Product Bulletin 837 for more information. 09/12/2022: Added part numbers for limited travel balance tubes for upper and lower balance tube use. 10/29/2022: Evergreen exterior discontinued. See Product Bulletin 851 for more details
2023	Double Hung	02/27/2023: Gunmetal exterior introduced. See Product Bulletin 863 for more details

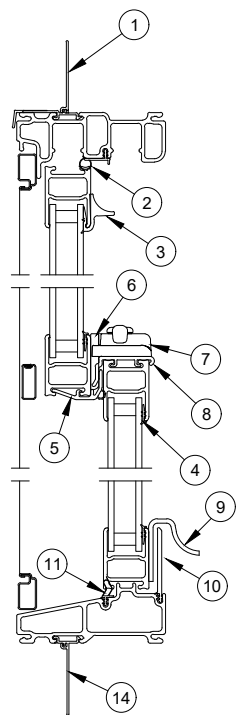

Head Jamb and Sill Detail

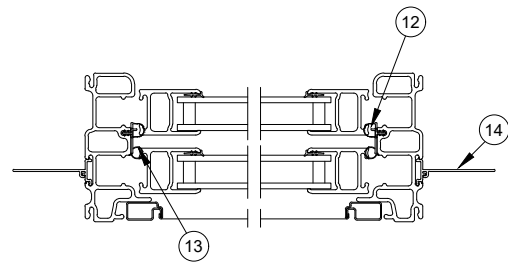

Jamb Detail

1. Head Jamb Nail Fin with Drip Cap, V2395 (see Accessories section)
2. Head Jamb Weather Strip, V1573/V2881
3. Sash Pull, V1594
4. Vinyl Glazing Boot, V1415 (see Accessories section)
5. Sash Cover, Stationary/Top, V1749
6. Sash Keeper
7. Sash Lock
8. Sash Cover, Bottom, V1509
9. Sash Lift
10. Sill Liner, V2697/V3002
11. Sill Weather Strip, V2099
12. Bottom Jamb Weather Strip, V1143
13. Top Jamb Weather Strip, V1573/V2881
14. Sill and Jamb Nail Fin, V1428 (see Accessories section)

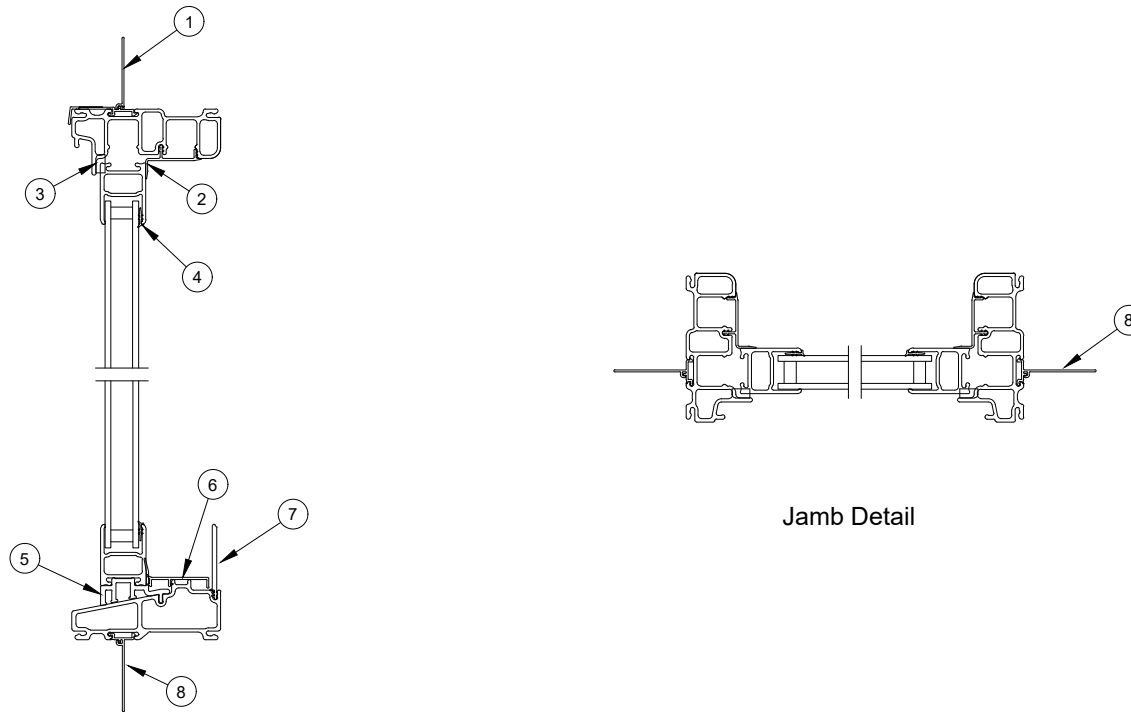

Head Jamb and Sill Detail

1. Head Jamb Nail Fin with Drip Cap, V2395 (see Accessories section)
2. Stationary Parting Stop, Head Jamb, V1405
3. Foam Tape
4. Vinyl Glazing Boot, V1415 (see Accessories section)
5. Leveling Block, V2070/V2859
6. Sill Filler, V2844
7. Sill Liner, V2697/V3002
8. Sill and Jamb Nail Fin, V1428 (see Accessories section)

Cam Lock

NOTE: If being used on a unit prior to 8/26/2013, both Cam Lock and Keeper will need to be replaced. A Forced Entry Clip will need to be ordered.

Usage dates:

08/26/2013 - present

Suggested Fasteners	PN
2 - #7-16 x 7/8" flat head screw	
Stone White	10840019
Almond Frost	11840774
Brass	11800787
Satin Nickel	11800796
Oil Rubbed Bronze*	11800794
*Used for Oil Rubbed Bronze and Matte Black	

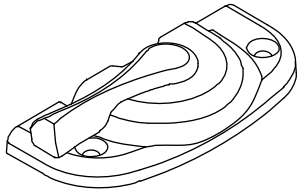

Keeper

NOTE: If being used on a unit prior to 8/26/2013, both Cam Lock and Keeper will need to be replaced. A Forced Entry Clip will need to be ordered.

Usage dates:

08/26/2013 - present

Suggested Fasteners	PN
2 - #7-16 x 7/8" flat head screw	
Stone White	10840019
Almond Frost	11840774
Brass	11800787
Satin Nickel	11800796
Oil Rubbed Bronze*	11800794
*Used for Oil Rubbed Bronze and Matte Black	

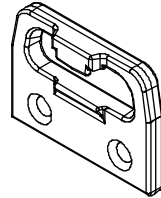

Cam Lock and Keeper

Includes:

- 1 – Lock
- 1 – Keeper
- 4 – #7-16 x 7/8" flat head screws

NOTE: If used on a unit prior to 8/26/2013 a Forced Entry Clip will need to be ordered.

Usage dates:

08/26/2013 - present

Color	PN
Stone White	11800921
Almond Frost	11800923
Brass	11800925
Satin Nickel	11800927
Oil Rubbed Bronze	11800929
Matte Black	11800934

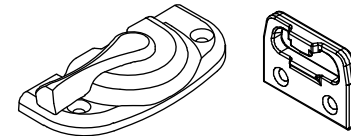

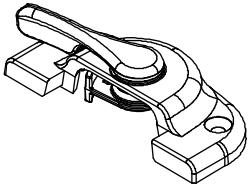

Sash Cam Lock

Usage Dates: 11/2006 to 08/26/2013

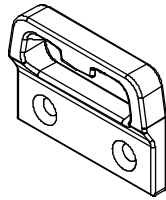

Sash Keeper

Usage Dates: 11/2006 to 08/26/2013

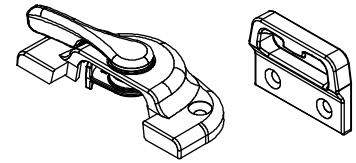

Sash Cam Lock and Keeper

Usage Dates: 11/2006 to 08/26/2013

Sash Cam Lock Limiter Kit

Includes:

- 1 - Sash cam lock limiter
- 1 - #6 x 1 1/4" Torx pan head screw
- 1 - Warning label
- 1 - Instruction

NOTE: 1 kit per lock

Color	PN
Stone White	11880480
Almond Frost	11880481
Brass	11880482
Satin Nickel	11880483
Oil Rubbed Bronze	11880484
Matte Black	11880485

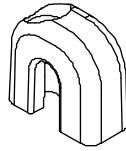

Lock Cam Spacer (For Service Only)

Color	PN
White	10506152
Black	10506153

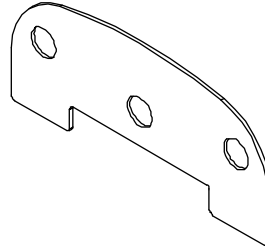

Sash Lift

Color	PN
Stone White	11867807
Bronze	11867809
Ebony	11867808

Suggested Fasteners	
2 - #7-16 x 7/8" flat head screw	
Color	PN
Stone White	10840019
Oil Rubbed Bronze	11800794
NOTE: Oil Rubbed Bronze used with Bronze or Ebony.	

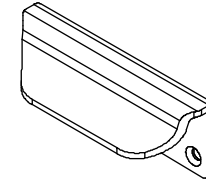

Bottom Sash Tilt Latch

Handing	Color and Part Number			
	Stone White	Bronze	Ebony	Gunmetal
LH	11860077	11860797	11860799	11860827
RH	11860076	11860796	11860798	11860826

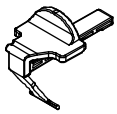

RH

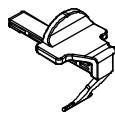

LH

Top Sash Tilt Latch

Color	PN
White	11860295
Black	10502134

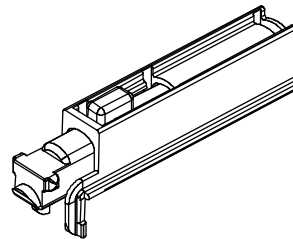

Tilt Pin, Kit

Includes:

- 1 - Tilt pin
- 1 - #8 x 5/8" Phillips pan head screw

Color	PN
Black	11812141

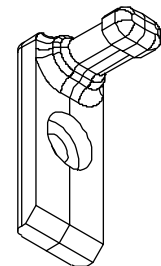

Weep Cover and Flap

Usage dates:

02/27/2017 - present

NOTE: These 2 parts will come assembled.

Color	PN
Stone White	10506722
Pebble	10506723
Bronze	10506724
Ebony	10506727
Cashmere	10506726
Gunmetal	10506743
*Evergreen	10506725

NOTE: *DISC (LA) used prior to 10/29/2022

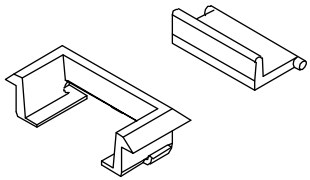

Balance Tube Clutch

Non-handed

Color	PN
Gray	105530

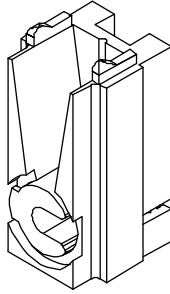

Sill Bracket, with tape

Tape is used for application

Color	PN
White	10506901
Black	10506902

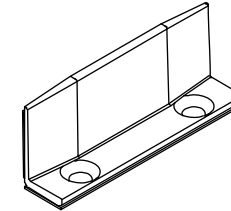

Drain Cover

Usage dates:

02/27/2017 - present

Color	PN
White	10506704
Black	10506733

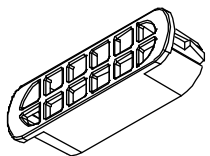

Forced Entry Clip

Usage dates:

08/26/2013 - present

PN
11860289

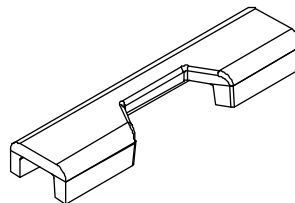

Operating Sash Peg

Color	PN
Stone White	11860294
Black	10502133

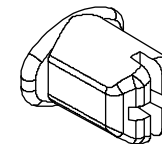

Top Sash Stop

V1172

Equal Sash Units		
Length	Color	PN
3 1/2" (89)	White	161900
	Black	161022
Cottage Units		
84" (2134)	White	161984
	Black	161084

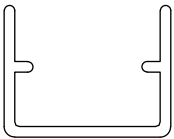

Bottom Sash Stop

V2204

Usage dates:

08/26/2013 - present

Length	White PN	Black PN
2 1/32" (52)	11802200	11802205
Lineal 144" (3658)	11802204	11802206

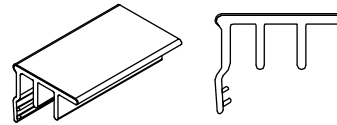

Sash Limiter Kit

Includes:

- 4 - Limiters
- 8 - #8-18 x 5/8 Phillips, flat head, Stainless Steel screw
- 2- #6 x 1/2 Torx head screws
- 1 - Warning label
- 1 - Instruction

Color	PN
White	11880180
Black	11881980

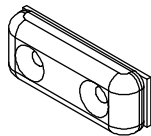

Bottom Sash Tilt Pin

Usage dates:

01/31/2007-12/15/2016

PN
10815279

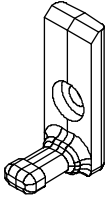

Bottom Sash Stop

Usage dates:

04//2006-08/26/2013

Color	PN
White	11860800



Sill Liner End Cap

NOTE: Use for replacement of sill liner seals on all units produced prior to 02/27/2017

Color	LH PN	RH PN
Stone White	11862644	11862643



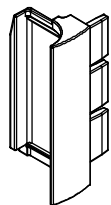

Sill Liner Seal

Usage Dates: 09/24/2007 to
02/27/2017

No longer available, replace with
Sill Liner End Cap.

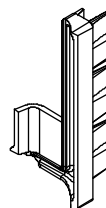

Sill Liner Seal

Usage Dates: 04/2006 to 09/2007

No longer available, replace with
Sill Liner End Cap.

Ordering Specifications (use all that apply):

1. Original order number
2. Balance ID code; (if not available provide the width and height of sash)
3. Glass type; (STC/OITC glass upgrade or not STC/OITC glass upgrade)
4. Divided lite
5. Sash ratio; (equal, cottage, or reverse cottage)

NOTE: In the following PN charts, upper and lower are used to indicate balance tube location for limited travel balance tubes. A “U” or “L” will be printed on the balance tube.

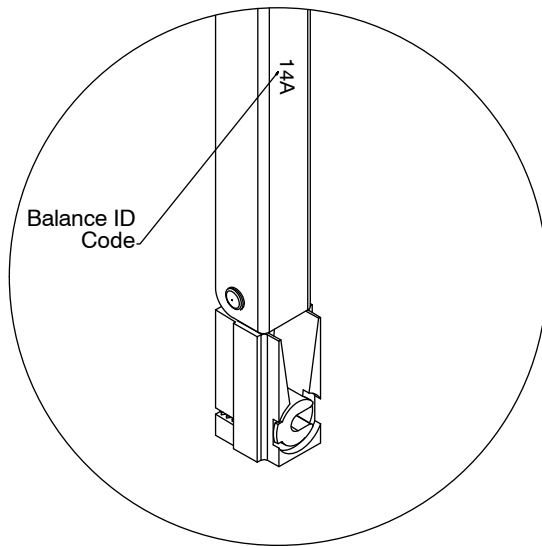

Balance ID Code	Part Number
10A	106010
10B	106110
10C	106210
10D	106310
10E	106410
10F	106510

Balance ID Code	Part Number
11A	106011
11B	106111
11C	106211
11D	106311
11E U (Upper)	106411
11E L (Lower)	206411

Balance ID Code	Part Number
12A	106012
12B	106112
12C	106212
12D	106312
12E U (Upper)	106412
12E L (Lower)	206412
12F U (Upper)	106512
12F L (Lower)	206512

Balance ID Code	Part Number
13A	106013
13B	106113
13C	106213
13D	106313
13E	106413
13F U (Upper)	106513
13F L (Lower)	206513

Balance ID Code	Part Number
14A	106014
14B	106114
14C	106214
14D	106314
14E	106414
14F	106514
14G U (Upper)	106614
14G L (Lower)	206614
14H U (Upper)	106714
14H L (Lower)	206714

Balance ID Code	Part Number
15A	106015
15B	106115
15C	106215
15D	106315
15E	106415
15F	106515
15G	106615

Balance ID Code	Part Number
16A	106016
16B	106116
16C	106216
16D	106316
16E	106416
16F	106516
16G	106616
16HU (Upper)	106716
16H L (Lower)	206716
16I U (Upper)	106816
16I L (Lower)	206816

Balance ID Code	Part Number
17A	106017
17B	106117
17C	106217
17D	106317
17E	106417
17F	106517
17G	106617

Balance ID Code	Part Number
18A	106018
18B	106118
18C	106218
18D	106318
18E	106418
18F	106518
18G	106618
18H	106718
18I U (Upper)	106818
18I L (Lower)	206818

Balance ID Code	Part Number
19A	106019
19B	106119
19C	106219
19D	106319
19E	106419
19F	106519
19G	106619
19H	106719

Balance ID Code	Part Number
20A	106020
20B	106120
20C	106220
20D	106320
20E	106420
20F	106520
20G	106620
20H U (Upper)	106720
20H L (Lower)	206720
20I U (Upper)	106820
20I L (Lower)	206820

Balance ID Code	Part Number
21A	106021
21B	106121
21C	106221
21D	106321
21E	106421
21F	106521
21G	106621

Balance ID Code	Part Number
22A	106022
22B	106122
22C	106222
22D	106322
22E	106422
22F	106522
22G	106622
22H	103722
22I U (Upper)	106822
22I L (Lower)	206822
22J U (Upper)	106922
22J L (Lower)	206922

Balance ID Code	Part Number
23A	109023
23B	106123
23C	106223
23D	106323
23E	106423
23F	106523
23G	106623
23H	106723

Balance ID Code	Part Number
24A	106024
24B	106124
24C	106224
24D	106324
24E	106424
24F	106524
24G	106624
24H	106724
24I U (Upper)	106824
24I L (Lower)	206824

Balance ID Code	Part Number
25A	106025
25B	106125
25C	106225
25D	106325
25E	106425
25F	106525
25G	106625
25H	106725

Balance ID Code	Part Number
26A	106026
26B	106126
26C	106226
26D	106326
26E	106426
26F	106526
26G	106626
26H	106726
26I U (Upper)	106826
26I L (Lower)	206826
26J U (Upper)	106926
26J L (Lower)	206926

Balance ID Code	Part Number
27A	106027
27B	106127
27C	106227
27D	106327
27E	106427
27F	106527
27G	106627
27H	106727

Balance ID Code	Part Number
28A	106028
28B	106128
28C	106228
28D	106328
28E	106428
28F	106528
28G	106628
28H	106728
28I U (Upper)	106828
28I L (Lower)	206828
28J U (Upper)	106928
28J L (Lower)	206928
28K U (Upper)	109028
28K L (Lower)	209028

Balance ID Code	Part Number
29A	106029
29B	106129
29C	106229
29D	106329
29E	106429
29F	106529
29G	106629
29H	106729

Balance ID Code	Part Number
30A	106030
30B	106130
30C	106230
30D	106330
30E	106430
30F	106530
30G	106630
30H	106730
30I U (Upper)	106830
30I L (Lower)	206830
30J U (Upper)	106930
30J L (Lower)	206930
30K U (Upper)	109030
30K L (Lower)	209030

Balance ID Code	Part Number
31A	106031
31B	106131
31C	106231
31D	106331
31E	106431
31F	106531
31G	106631
31H	106731
31I U (Upper)	106831
31I L (Lower)	206831
31J U (Upper)	106931
31J L (Lower)	206931

Balance ID Code	Part Number
32A	106032
32B	106132
32C	106232
32D	106332
32E	106432
32F	106532
32G	106632
32H	106732
32I U (Upper)	106832
32I L (Lower)	206832
32J U (Upper)	106932
32J L (Lower)	206932
32J U (Upper)	106933
32J L (Lower)	206933
32K U (Upper)	109032
32K L (Lower)	209032
32L U (Upper)	109132
32L L (Lower)	209132
32M U (Upper)	109232
32M L (Lower)	209232

Balance ID Code	Part Number
33A	106033
33B	106133
33C	106233
33D	106333
33E	106433
33F	106533
33G	106633
33H	106733
33I	106833
33J U	106933

Balance ID Code	Part Number
34A	106034
34B	106134
34C	106234
34D	106334
34E	106434
34F	106534
34G	106634
34H	106734
34I	106834
34J U (Upper)	106934
34J L (Lower)	206934
34K U (Upper)	109034
34K L (Lower)	209034
34L U (Upper)	109134
34L L (Lower)	209134
34M U (Upper)	109234
34M/L (Lower)	209234
34N U (Upper)	109334
34N/L (Lower)	209334

Balance ID Code	Part Number
35A	106035
35B	106135
36C	106235
35D	106335
35E	166435
35F	106535
35G	106635
35H	106735
35I	106835
35J U (Upper)	109935
35J L (Lower)	209935
35K U (Upper)	108035
35K L (Lower)	208035

Balance ID Code	Part Number
36A	106036
36B	106136
36C	106236
36D	106336
36E	106436
36F	106536
36G	106636
36H	106736
36I	106836
36JU (Upper)	106936
36J/L (Lower)	206936
36KU (Upper)	109036
36K/L (Lower)	209036
36LU (Upper)	109136
36L L (Lower)	209136
36MU-41 (Upper)	109236
36M-41 (Lower)	209236
36NU-42 (Upper)	109336
36N/L-42 (Lower)	209336
36NU-43 (Upper)	109436
36N/L-43 (Lower)	209436

Balance ID Code	Part Number
37A	106037
37B	106137
37C	106237
37D	106337
37E	106437
37F	106537
37G	106637
37H	106737
37I	106837
37J U (Upper)	106937
37J/L (Lower)	206937
37K U (Upper)	109037
37K L (Lower)	209037
37U (Upper)	109137
37/L (Lower)	209137

Balance ID Code	Part Number
38A	106038
38B	106138
38C	106238
38D	106338
38E	106438
38F	106538
38G	106638
38H	106738
38I	106838
38JU (Upper)	106938
38J L (Lower)	206938
38K U (Upper)	109038
38K L (Lower)	209038
38L U (Upper)	109138
38L L (Lower)	209138
38M U (Upper)	109238
38M/L (Lower)	209238
38N U (Upper)	109338
38N/L (Lower)	209338
38O U (Upper)	109438
38O/L (Lower)	209438
38P U (Upper)	109538
38P/L (Lower)	209538

Balance ID Code	Part Number
39AA	105039
39K U/L	109038
39L U/L	109138

Balance ID Code	Part Number
40A	106040
40B	106140
40C	106240
40D	106340
40E	106440
40F	106540
40G	106640
40H	106740
40I	106840
40J U (Upper)	106940
40J L (Lower)	206940
40K U (Upper)	109040
40K L (Lower)	209040
40L U (Upper)	109140
40L L (Lower)	209140
40M U (Upper)	109240
40M/L (Lower)	209240
40N U (Upper)	109340
40N/L (Lower)	209340
40O U (Upper)	109440
40O/L (Lower)	209440

Balance ID Code	Part Number
41AA	105041
41A	106041
41B	106141
41C	106241
41D	106341
41E	106441
41F	106541
41G	106641
41H	106741
41I	106841
41J U (Upper)	106941
41J/L (Lower)	206941
41K U (Upper)	109041
41K/L (Lower)	209041
41L U (Upper)	109141
41L/L (Lower)	209141

Balance ID Code	Part Number
42A	106042
42B	106142
42C	106242
42D	106342
42E	106442
42F	106542
42G	106642
42H	106742
42I	106842
42J U (Upper)	106942
42J L (Lower)	206942
42K U (Upper)	107242
42K L (Lower)	207242
42L U (Upper)	109142
42L L (Lower)	209142
42M U (Upper)	109242
42M/L (Lower)	209242

Balance ID Code	Part Number
43AA	105043
43A	106043
43B	106143
43C	106243
43D	106343
43E	106443
43F	106543
43G	106643
43H	106743
43I	106843
43J U (Upper)	106943
43J/L (Lower)	206943
43K U (Upper)	109043
43K/L (Lower)	209043
43L U (Upper)	109143
43L L (Lower)	209143

Balance ID Code	Part Number
44AA	105044
44A	106044
44B	106144
44C	106244
44D	106344
44E	106444
44F	106544
44G	106644
44H	106744
44I	106844
44J U (Upper)	106945
44J L (Lower)	206945
44K U (Upper)	107044
44K L (Lower)	207044
44L U (Upper)	109144
44L L (Lower)	209144

WOCD Field Applied and Replacement Kit

Includes:

- 1 - Field Installation instructions
- 1 - Hang tag
- 2 - Safety and operating instructions
- 1 - WOCD sticker
- 2 - Mini AVL WOCD

NOTE: Quantity of 2 needed per unit.

Color	PN
Stone White	11902905
Black	11902907

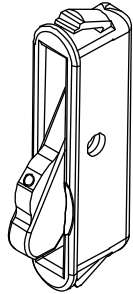

NOTE: For windows without factory-applied WOCD, refer to Product Bulletin 758 for more information.

Sill Liner

V3002

Usage dates:

12/16/2019 - present

NOTE: Replaces V2846 used 02/27/2017 - 12/15/2019

CN	Length	Color and Part Number		
		Bronze	Ebony	Gunmetal
CN16	16 47/64" (725)	41511016	41511116	41519116
CN20	22 47/64" (577)	41511020	41511120	41519120
CN26	28 47/64" (730)	41511026	41511126	41519126
CN28	30 47/64" (781)	41511028	41511128	41519128
CN30	34 47/64" (882)	41511030	41511130	41519130
CN36	40 47/64" (1035)	41511036	41511136	41519136
CN40	46 47/64" (1187)	41511040	41511140	41519140
CN50	58 47/64" (1492)	41511050	41511150	41519150
CN60	70 47/64" (1797)	41511060	41511160	41519160
Lineal	96" (2438)	41511096	41511196	41519196



Sill Liner

V2697

Usage dates:

02/27/2017 - present

CN	Length	Stone White PN
CN16	16 47/64" (725)	31511316
CN20	22 47/64" (577)	31511320
CN26	28 47/64" (730)	31511326
CN28	30 47/64" (781)	31511328
CN30	34 47/64" (882)	31511330
CN36	40 47/64" (1035)	31511336
CN40	46 47/64" (1187)	31511340
CN50	58 47/64" (1492)	31511350
CN60	70 47/64" (1797)	31511360
Lineal	96" (2438)	31511396



Sill Filler, Picture/Transom

V2844

Usage dates:

02/27/2017 - present

CN	Length	Color and Part Number			
		Stone White	Bronze	Ebony	Gunmetal
CN16	15 7/16" (392)	31512416	31512516	31512616	31519616
CN20	21 7/16" (545)	31512420	31512520	31512620	31519620
CN26	27 7/16" (697)	31512426	31512526	31512626	31519626
CN28	29 7/16" (748)	31512428	31512528	31512628	31519628
CN30	33 7/16" (849)	31512430	31512530	31512630	31519630
CN36	39 7/16" (1002)	31512436	31512536	31512636	31519636
CN40	45 7/16" (1154)	31512440	31512540	31512640	31519640
CN50	57 7/16" (1459)	31512450	31512550	31512650	31519650
CN60	69 7/16" (1764)	31512460	31512560	31512660	31519660
Lineal	144" (3658)	31512499	31512599	31512699	31519699

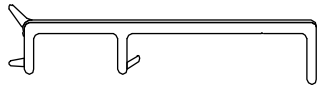

Sash Cover

V1509

Single Lock					
CN	Length	Color and Part Number			
		Stone White	Bronze	Ebony	Gunmetal
CN16	15 1/4" (3871)	17043718	15919416	15919316	15999316
CN20	21 1/4" (540)	17043724	15919420	15919320	15999320
CN26	27 1/4" (692)	17043730	15919426	15919326	15999326

Double Lock					
CN	Length	Color and Part Number			
		Stone White	Bronze	Ebony	Gunmetal
CN28	29 1/4" (743)	17043833	15919728	15919228	15999028
CN30	33 1/4" (845)	17043836	15919730	15919230	15999030
CN36	39 1/4" (997)	17043842	15919736	15919236	15999036
CN40	45 1/4" (1149)	17043848	15919740	15919240	15999040

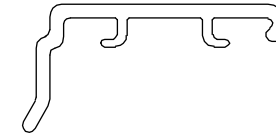

Stationary Parting Stop

V1405

Head Jamb					
CN	Length	Stone White	Bronze	Ebony	Gunmetal
CN16	15 7/16" (392)	22000516	23000716	23000616	23000816
CN20	21 7/16" (545)	22000520	23000720	23000620	23000820
CN26	27 7/16" (697)	22000526	23000726	23000626	23000826
CN28	29 7/16" (748)	22000528	23000728	23000628	23000828
CN30	33 7/16" (773)	22000530	23000730	23000630	23000830
CN36	39 7/16" (1001)	22000536	23000736	23000636	23000836
CN40	45 7/16" (1154)	22000540	23000740	23000640	23000840
CN50	57 7/16" (1459)	22000550	23000750	23000650	23000850
CN60	69 7/16" (1764)	22000560	23000760	23000660	23000860

Jamb					
CN	Length	Stone White	Bronze	Ebony	Gunmetal
CN10	9 15/16" (252)	21000810	22000710	22000610	22000810
CN16	15 15/16" (405)	21000816	22000716	22000616	22000816
CN20	21 15/16" (557)	21000820	22000720	22000620	22000820
CN26	27 15/16" (710)	21000826	22000726	22000626	22000826
CN30	33 15/16" (862)	21000830	22000730	22000630	22000830
CN36	39 15/16" (1014)	21000836	22000736	22000636	22000836
CN40	45 15/16" (1167)	21000840	22000740	22000640	22000840
CN46	51 15/16" (1319)	21000846	22000746	22000646	22000846
CN50	57 15/16" (1472)	21000850	22000750	22000650	22000850
CN56	63 15/16" (1624)	21000856	22000756	22000656	22000856
CN60	69 15/16" (1776)	21000860	22000760	22000660	22000860
Lineal	96" (2438)	21000596	22000796	22000696	22000896

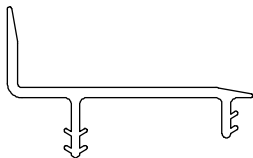

Sash Pull

V1594 Stone White

V1595 Bronze/Ebony/Gunmetal

NOTE: Adhesive backed

CN	Length	Stone White	Bronze	Ebony	Gunmetal
CN16	12 5/8" (321)	15900416	15909216	15909116	15999216
CN20	18 5/8" (473)	15900420	15909220	15909120	15999220
CN26	24 5/8" (625)	15900426	15909226	15909126	15999226
CN28	26 5/8" (676)	15900428	15909228	15909128	15999228
CN30	30 5/8" (778)	15900430	15909230	15909130	15999230
CN36	36 5/8" (930)	15900436	15909236	15909136	15999236
CN40	42 5/8" (1083)	15900440	15909240	15909140	15999240

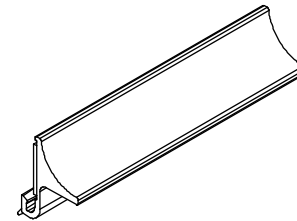

Leveling Block

V2070/V2859

Usage dates:

05/2011 - present

NOTE: When replacing leveling blocks for units produced before 05/2011 the end caps will also need to be replaced using the current end caps.

CN	Length	Exterior Color and Part Number									
		Stone White	Pebble	Cashmere	Ebony	Bronze	Gunmetal	Bronze	Ebony	Gunmetal	*Evergreen
		Interior Color and Part number									
		Stone White					Bronze	Ebony	Gunmetal	Stone White	
CN16	15 1/4" (387)	11201116	11201216	11201516	11307116	11305116	11387116	11308116	11309116	11389116	11306116
CN20	21 1/4" (540)	11201120	11201220	11201520	11307120	11305120	11387120	11308120	11309120	11389120	11306120
CN26	27 1/4" (692)	11201126	11201226	11201526	11307126	11305126	11387126	11308126	11309126	11389126	11306126
CN28	29 1/4" (743)	11201128	11201228	11201528	11307128	11305128	11387128	11308128	11309128	11389128	11306128
CN30	33 1/4" (845)	11201130	11201230	11201530	11307130	11305130	11387130	11308130	11309130	11389130	11306130
CN36	39 1/4" (870)	11201136	11201236	11201536	11307136	11305136	11387136	11308136	11309136	11389136	11306136
CN40	45 1/4" (1149)	11201140	11201240	11201540	11307140	11305140	11387141	11308140	11309140	11389140	11306140
CN50	57 1/4" (1454)	11201150	11201250	11201550	11307150	11305150	11387152	11308150	11309150	11389150	11306150
Lineal	96" (2438)	11201199	11201299	11201599	11307196	11305196	11387196	11308196	11309196	11389196	11306196

Suggested Fasteners	PN
2-#7 x 3/4" Phillips, pan head, full thread screws	118036

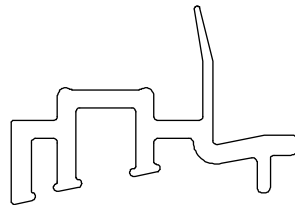

NOTE: *DISC (LA) used prior to 10/29/2022

Balance Tube Cover

V2870

Length	Black PN
9 1/16" (230)	11002809
10 1/16" (255)	11002810
11 1/16" (281)	11002811
12 1/16" (306)	11002812
13 1/16" (331)	11002813
14 1/16" (357)	11002814
15 1/16" (382)	11002815
16 1/16" (408)	11002816
17 1/16" (433)	11002817
18 1/16" (458)	11002818
19 1/16" (484)	11002819
20 1/16" (509)	11002820
21 1/16" (535)	11002821
22 1/16" (560)	11002822
23 1/16" (585)	11002823
24 1/16" (611)	11002824
25 1/16" (636)	11002825
26 1/16" (662)	11002826

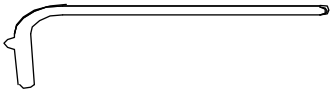

Length	Black PN
27 1/16" (687)	11002827
28 1/16" (712)	11002828
29 1/16" (738)	11002829
30 1/16" (763)	11002830
31 1/16" (789)	11002831
32 1/16" (814)	11002832
33 1/16" (839)	11002833
34 1/16" (865)	11002834
35 1/16" (890)	11002835
36 1/16" (916)	11002836
37 1/16" (941)	11002837
38 1/16" (966)	11002838
39 1/16" (992)	11002839
40 1/16" (1017)	11002840
41 1/16" (1043)	11002851
42 1/16" (1068)	11002842
43 1/16" (1093)	11002843

Sash Cover, Stationary/Top Sash

V1749

NOTE: Used on Top Sash

CN	Length	Black PN	*Beige PN
CN16	15 1/4" (387)	15919016	17005916
CN20	21 1/4" (540)	15919020	17005920
CN26	27 1/4" (692)	15919026	17005926
CN28	29 1/4" (743)	15919028	17005928
CN30	33 1/4" (845)	15919030	17005930
CN36	39 1/4" (997)	15919036	17005936
CN40	45 1/4" (1149)	15919040	17005940

NOTE: *DISC (LA) used prior to 06/27/2022

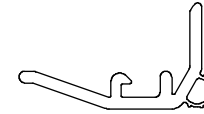

Leveling Block

V1472

Usage dates:

04/2006 - 10/2007. NOTE: Interior color is Stone White.

CN	Length	Exterior Color and Part Number		
		Stone White	Pebble	Bronze
CN16	15 3/16" (386)	11007216	11007217	11007316
CN20	21 3/16" (538)	11007220	11007221	11007320
CN26	27 3/16" (691)	11007226	11007227	11007326
CN30	33 3/16" (843)	11007230	11007231	11007330
CN36	39 3/16" (985)	11007236	11007237	11007336
CN40	45 3/16" (1148)	11007240	11007241	11007340
CN50	57 3/16" (1453)	11007250	11007251	11007350
Lineal	96" (2438)	11007296	11007297	11007396

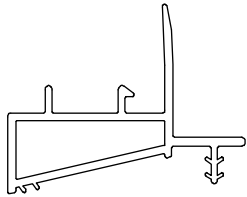

Sill Liner

V1552

Usage dates:

09/24/2007 - 02/27/2017. For units produced before 02/27/17 replace sill liner seal as well with sill liner end cap.

CN	Length	Stone White PN
CN16	15 15/64" (387)	31511216
CN20	21 15/64" (539)	31511220
CN26	27 15/64" (692)	31511226
CN28	29 15/64" (743)	31511228
CN30	33 15/64" (844)	31511230
CN36	39 15/64" (997)	31511236
CN40	45 15/64" (1149)	31511240
CN50	57 15/64" (1454)	31511250
CN60	69 15/64" (1759)	31511260
Lineal	96" (2438)	31511296

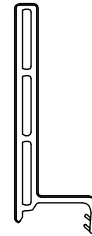

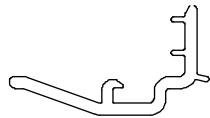

Sash Cover Top, V1510
Used 03/2007 to 07/2008
No longer available,
replace with V1749.

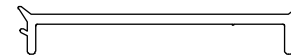

Sill Filler, Picture/Transom, V1557
Used 3/2007 to 2/27/2017
No longer available,
replace with V2844.

Ordering Specifications for Configured Parts in OMS:

1. Unit type;
2. component;
3. exterior color;
4. application type;
5. unit size;
6. sash division;
7. component location.

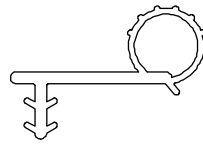

Frame Weather Strip
V1573/V2881

Frame Weather Strip

V1573/V2881

Head Jamb					
CN	Length	Stone White	Ebony	Bronze	Gunmetal
CN16	15 1/4" (387)	15900816	15900916	15901516	15909516
CN20	21 1/4" (539)	15900820	15900920	15901520	15909520
CN26	27 1/4" (692)	15900826	15900926	15901526	15909526
CN28	29 1/4" (742)	15900828	15900928	15901528	15909528
CN30	33 1/4" (845)	15900830	15900930	15901530	15909530
CN36	39 1/4" (997)	15900836	15900936	15901536	15909536
CN40	45 1/4" (1149)	15900840	15900940	15901540	15909540

Top Jamb - Equal Sash					
CN	Length	Stone White	Ebony	Bronze	Gunmetal
CN20	11 5/32" (283)	15900511	15902611	15903611	15909611
CN26	14 5/32" (360)	15900514	15902614	15903614	15909614
CN30	17 5/32" (436)	15900517	15902617	15903617	15909617
CN36	20 5/32" (512)	15900520	15902620	15903620	15909620
CN40	23 5/32" (588)	15900523	15902623	15903623	15909623
CN46	26 5/32" (664)	15900526	15902626	15903626	15909626
CN50	29 5/32" (741)	15900529	15902629	15903629	15909629
CN56	32 5/32" (817)	15900532	15902632	15903632	15909632
CN60	35 5/32" (893)	15900535	15902635	15903635	15909635
CN66	38 5/32" (969)	15900538	15902638	15903638	15909638
Lineal	96" (2438)	15900596	15902696	15903696	15909696

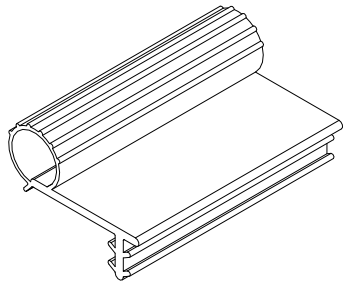

Frame Weather Strip

V1143

Usage dates:

11/2007 - present

Bottom Jamb - Equal Sash		
CN	Length	Black PN
CN20	10 7/16" (265)	15906710
CN26	13 7/16" (341)	15906713
CN30	16 7/16" (418)	15906716
CN36	19 7/16" (494)	15906719
CN40	22 7/16" (570)	15906722
CN46	25 7/16" (646)	15906725
CN50	28 7/16" (722)	15906728
CN56	31 7/16" (799)	15906731
CN60	34 7/16" (875)	15906734
CN66	37 7/16" (951)	15906737
Lineal	96" (2438)	15906799

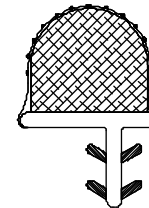

Sill Weather Strip

V2099

Usage dates:

08/29/2011 - present

CN	Length	Black PN
CN16	15 1/4" (387)	11811016
CN20	21 1/4" (540)	11811020
CN26	27 1/4" (692)	11811026
CN28	29 1/4" (743)	11811028
CN30	33 1/4" (845)	11811030
CN36	39 1/4" (997)	11811036
CN40	45 1/4" (1149)	11811040
Lineal	96" (2438)	11811096



Check Rail Dust Block

1 1/4" x 1 3/8"

NOTE: Adhesive backed

Color	PN
Gray	10500049

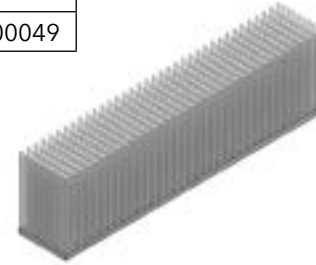

Balance Tube Foam Plug

3/4" x 3/4" x 1/2"

Usage dates:

08/26/2013 to present

Color	PN
White	10500104

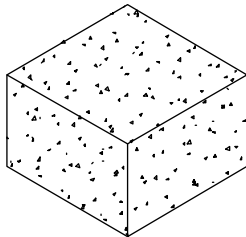

Foam Rope

V1244

7/32" (6) diameter

Length	Color	PN
50' (15240)	Beige	15910050

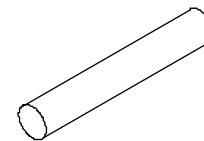

Frame Weather Strip

V1143

Usage dates:

Gray used 03/2007 to 11/2007

Beige used 11/2007 to 06/27/2022

Bottom Jamb			
CN	Length	Gray PN	Beige PN
CN20	10 7/16" (265)	15900610	15906610
CN26	13 7/16" (341)	15900613	15906613
CN30	16 7/16" (418)	15900616	15906616
CN36	19 7/16" (494)	15900619	15906619
CN40	22 7/16" (570)	15900622	15906622
CN46	25 7/16" (546)	15900625	15906625
CN50	28 7/16" (722)	15900628	15906628
CN56	31 7/16" (799)	15900631	15906631
CN60	34 7/16" (875)	15900634	15906634
CN66/CN56C	37 7/16" (951)	15900637	15906637
Lineal	96" (2438)	15900699	15906699

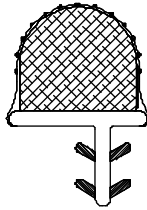

Sill Weather Strip

V1452

Usage dates:

Beige used 11/2007 - 02/22/2010

Gray used 03/2007 - 11/2007

Sill			
CN	Length	Beige PN	Gray PN
CN16	15 1/4" (387)	17333318	NA
CN20	21 1/4" (540)	17333324	
CN26	27 1/4" (692)	17333330	
CN28	29 1/4" (743)	17333333	
CN30	33 1/4" (845)	17333336	
CN36	39 1/4" (997)	17333342	
CN40	45 1/4" (1149)	17333348	
Lineal	96" (2438)	17333396	

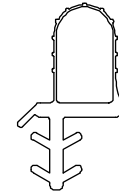

Sill Weather Strip

V2099

Usage dates:

08/29/2011 to 06/27/2022

CN	Length	Beige PN
CN16	15 1/4" (387)	17001116
CN20	21 1/4" (540)	17001120
CN26	27 1/4" (692)	17001126
CN28	29 1/4" (743)	17001128
CN30	33 1/4" (845)	17001130
CN36	39 1/4" (997)	17001136
CN40	45 1/4" (1149)	17001140
Lineal	96" (2438)	17011199



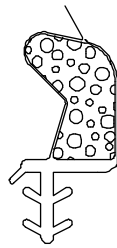

Sill Weather Strip, V1992

Usage dates: 02/22/2010 - 08/29/2011

No longer available, replace with V2099.

To order, specify:

1. Which sash is being replaced - top and bottom;
2. equal sash, cottage, or reverse cottage units;
3. size - provide the corresponding call number, rough opening, frame size, or outside measurement;
4. glazing;
5. color; hardware option; original order number if available, whether or not the original sash was made before or after 3/26/07.
6. if unit has an opening control device, state this on the order;
7. original order number if available.

NOTE: Use the sash, frame and DLO charts to help determine sash and screen sizes. Original order number can be found etched into corner of glass or on label adhered to side of sash frame.

NOTE: Picture and Transom sash include replacement parting stops and sill fillers.

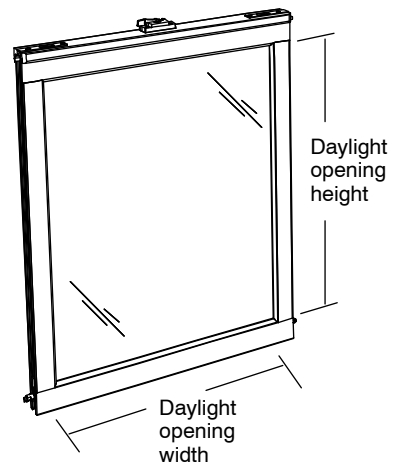

To order, specify:

1. Size – provide the corresponding call number, rough opening, frame size, or outside measurement;
2. color;
3. half or full screen;
4. equal sash, cottage, or reverse cottage units;
5. original order number if available.

NOTE: Use the sash, frame and DLO charts to help determine sash and screen sizes. Original order number can be found etched into corner of glass or on label adhered to side of sash frame.

NOTE: OM of screen includes corner keys.

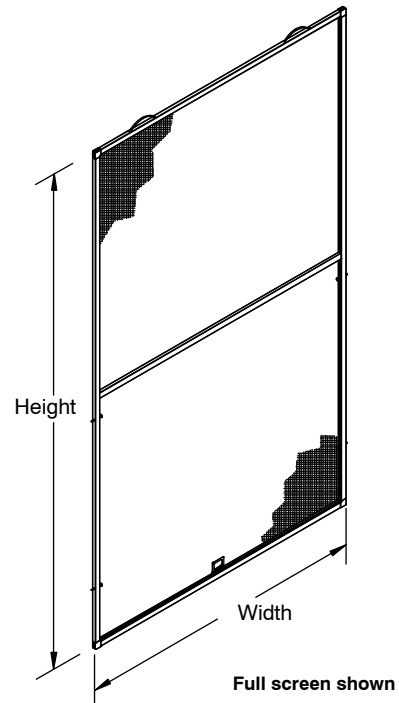

Friction Plunger, Screen

Usage dates:

01/28/2019 - present

Color	PN
Clear	10508195

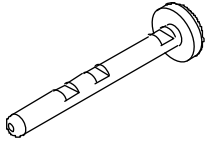

Screen Leaf Spring

Usage dates:

01/28/2019 - present

PN
11900897

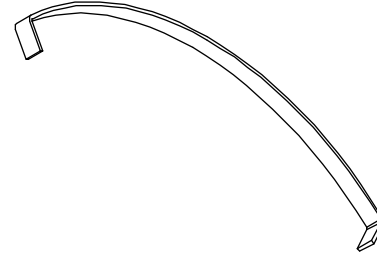

Screen Plunger Kit

Includes:

- 1 - Plunger Bolt
- 1 - Plunger Spring
- 1 - Plunger Cap, Black

Usage dates:

03/2007 - 1/27/2019

PN
11851053

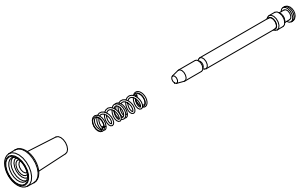

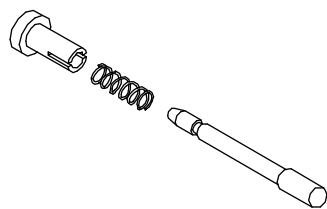

Plunger and Spring Assembly

Plunger bolt (off white), Plunger cap (clear)

Used: 03/2007 - 01/27/2019

Use this chart to determine sizes for replacement sash and screen.

- Daylight Opening (DLO) is a measurement of the visible glass.
- Outside measurement = OM
- Sizes for Double Hung manufactured 03/26/2007 - present

NOTE: Sash OM does not include sash covers.

Operator Sash - Equal Sash Units					
Width					
CN	Frame OM	Sash OM	1/2 Screen OM	Full Screen OM	DLO
16	17 1/2" (445)	15 1/4" (387)	15 23/32" (401)	15 23/32" (401)	12 9/16" (319)
20	23 1/2" (597)	21 1/4" (540)	21 23/32" (553)	21 23/32" (553)	18 9/16" (471)
26	29 1/2" (749)	27 1/4" (692)	27 23/32" (629)	27 23/32" (629)	24 9/16" (624)
28	31 1/2" (800)	29 1/4" (743)	29 23/32" (736)	29 23/32" (736)	26 9/16" (675)
30	35 1/2" (902)	33 1/4" (845)	33 23/32" (706)	33 23/32" (706)	30 9/16" (776)
36	41 1/2" (1054)	39 1/4" (997)	39 23/32" (1010)	39 23/32" (1010)	36 9/16" (929)
40	47 1/2" (1207)	45 1/4" (1149)	45 23/32" (1163)	45 23/32" (1163)	42 9/16" (1081)
Height					
20	23 1/2" (597)	11" (279)	11 1/8" (283)	21 15/16" (557)	8 5/16" (211)
26	29 1/2" (749)	14" (356)	14 1/8" (359)	27 15/16" (710)	11 5/16" (287)
30	35 1/2" (851)	17" (432)	17 1/8" (435)	33 15/16" (862)	14 5/16" (364)
36	41 1/2" (1054)	20" (508)	20 1/8" (511)	39 15/16" (1014)	17 5/16" (440)
40	47 1/2" (1207)	23" (584)	23 1/8" (587)	45 15/16" (1167)	20 5/16" (516)
46	53 1/2" (1359)	26" (660)	26 1/8" (664)	51 15/16" (1319)	23 5/16" (592)
50	59 1/2" (1511)	29" (737)	29 1/8" (740)	57 15/16" (1472)	26 5/16" (668)
56	65 1/2" (1664)	32" (813)	32 1/8" (816)	63 15/16" (1624)	29 5/16" (745)
60	71 1/2" (1816)	35" (889)	35 1/8" (892)	69 15/16" (1776)	32 5/16" (821)
66	77 1/2" (1969)	38" (965)	38 1/8" (994)	75 15/16" (1929)	35 5/16" (897)

Picture/Transom Sash			
Width			
CN	Frame OM	Sash OM	DLO
16	17 1/2" (445)	15 1/4" (387)	12 9/16" (319)
20	23 1/2" (597)	21 1/4" (540)	18 9/16" (471)
26	29 1/2" (749)	27 1/4" (692)	24 9/16" (624)
28	31 1/2" (800)	29 1/4" (743)	26 9/16" (675)
30	35 1/2" (902)	33 1/4" (845)	30 9/16" (776)
36	41 1/2" (1054)	39 1/4" (997)	36 9/16" (929)
40	47 1/2" (1207)	45 1/4" (1149)	42 9/16" (1081)
50	59 1/2" (1511)	57 1/4" (1454)	54 9/16" (1691)
60	71 1/2" (1816)	69 1/4" (1759)	66 9/16" (1691)
Height			
10	11 1/2" (292)	9 1/4" (235)	6 9/16" (167)
16	17 1/2" (445)	15 1/4" (387)	12 9/16" (319)
20	23 1/2" (597)	21 1/4" (540)	18 9/16" (471)
26	29 1/2" (749)	27 1/4" (692)	24 9/16" (624)
30	35 1/2" (851)	33 1/4" (845)	30 9/16" (776)
36	41 1/2" (1054)	39 1/4" (997)	36 9/16" (929)
40	47 1/2" (1207)	45 1/4" (1149)	42 9/16" (1081)
46	53 1/2" (1359)	51 1/4" (1302)	48 9/16" (1233)
50	59 1/2" (1511)	57 1/4" (1454)	54 9/16" (1386)
56	65 1/2" (1664)	63 1/4" (1607)	60 9/16" (1538)
60	71 1/2" (1816)	69 1/4" (1759)	66 9/16" (1691)
66	77 1/2" (1969)	75 1/4" (1911)	72 9/16" (1843)

Use this chart to determine sizes for replacement sash and screen.

- Daylight Opening (DLO) is a measurement of the visible glass.
- Outside measurement = OM
- Sizes for Double Hung manufactured 03/26/2007 - present

Operator Sash - Cottage Units					
Width					
Unit CN	Frame OM	Sash OM	1/2 Screen OM	Full Screen OM	DLO
16	17 1/2" (445)	15 1/4" (387)	15 23/32" (401)	15 23/32" (401)	12 9/16" (319)
20	23 1/2" (597)	21 1/4" (540)	21 23/32" (553)	21 23/32" (553)	18 9/16" (471)
26	29 1/2" (749)	27 1/4" (692)	27 23/32" (629)	27 23/32" (629)	24 9/16" (624)
28	31 1/2" (800)	29 1/4" (743)	29 23/32" (736)	29 23/32" (736)	26 9/16" (675)
30	35 1/2" (902)	33 1/4" (845)	33 23/32" (706)	33 23/32" (706)	30 9/16" (776)
36	41 1/2" (1054)	39 1/4" (997)	39 23/32" (1010)	39 23/32" (1010)	36 9/16" (929)
40	47 1/2" (1207)	45 1/4" (1149)	45 23/32" (1163)	45 23/32" (1163)	42 9/16" (1081)
Height					
26 top	29 1/2" (749)	11 17/32" (279)		27 15/16" (710)	8 13/16" (224)
26 btm		16 15/32" (419)	16 19/32" (422)		13 25/32" (350)
30 top	35 1/2" (851)	13 29/32" (354)		33 15/16" (862)	11 7/32" (285)
30 btm		20 3/32" (510)	20 7/32" (513)		17 13/32" (442)
36 top	41 1/2" (1054)	16 5/16" (415)		39 15/16" (1014)	13 5/8" (346)
36 btm		23 11/16" (602)	23 13/16" (605)		21" (533)
40 top	47 1/2" (1207)	18 23/32" (475)		45 15/16" (1167)	16 1/32" (407)
40 btm		27 9/32" (693)	27 13/32" (696)		24 19/32" (625)
46 top	53 1/2" (1359)	21 1/8" (536)		51 15/16" (1319)	18 7/16" (468)
46 btm		30 7/8" (785)	31" (788)		28 3/16" (716)
50 top	59 1/2" (1511)	23 17/32" (597)		57 15/16" (1472)	20 13/16" (529)
50 btm		34 15/32" (876)	34 19/32" (879)		31 25/32" (808)
56 top	65 1/2" (1664)	26" (660)		63 15/16" (1624)	23 5/16" (592)
56 btm		38" (965)	38 1/8" (969)		35 5/16" (897)

Use this chart to determine sizes for replacement sash and screen.

- Daylight Opening (DLO) is a measurement of the visible glass.
- Outside measurement = OM
- Sizes for Double Hung manufactured 03/26/2007 - present

Operator Sash - Reverse Cottage Units					
Width					
Unit CN	Frame OM	Sash OM	1/2 Screen OM	Full Screen OM	DLO
16	17 1/2" (445)	15 1/4" (387)	15 23/32" (401)	15 23/32" (401)	12 9/16" (319)
20	23 1/2" (597)	21 1/4" (540)	21 23/32" (553)	21 23/32" (553)	18 9/16" (471)
26	29 1/2" (749)	27 1/4" (692)	27 23/32" (629)	27 23/32" (629)	24 9/16" (624)
28	31 1/2" (800)	29 1/4" (743)	29 23/32" (736)	29 23/32" (736)	26 9/16" (675)
30	35 1/2" (902)	33 1/4" (845)	33 23/32" (706)	33 23/32" (706)	30 9/16" (776)
36	41 1/2" (1054)	39 1/4" (997)	39 23/32" (1010)	39 23/32" (1010)	36 9/16" (929)
40	47 1/2" (1207)	45 1/4" (1149)	45 23/32" (1163)	45 23/32" (1163)	42 9/16" (1081)
Height					
26 top	29 1/2" (749)	16 15/32" (419)		27 15/16" (710)	13 25/32" (350)
26 btm		11 17/32" (279)	16 19/32" (422)		8 13/16" (224)
30 top	35 1/2" (851)	20 3/32" (510)		33 15/16" (862)	17 13/32" (442)
30 btm		13 29/32" (354)	20 7/32" (513)		11 7/32" (285)
36 top	41 1/2" (1054)	23 11/16" (602)		39 15/16" (1014)	21" (533)
36 btm		16 5/16" (415)	23 13/16" (605)		13 5/8" (346)
40 top	47 1/2" (1207)	27 9/32" (693)		45 15/16" (1167)	24 19/32" (625)
40 btm		18 23/32" (475)	27 13/32" (696)		16 1/32" (407)
46 top	53 1/2" (1359)	30 7/8" (785)		51 15/16" (1319)	28 3/16" (716)
46 btm		21 1/8" (536)	31" (788)		18 7/16" (468)
50 top	59 1/2" (1511)	34 15/32" (876)		57 15/16" (1472)	31 25/32" (808)
50 btm		23 17/32" (597)	34 19/32" (879)		20 13/16" (529)
56 top	65 1/2" (1664)	38" (965)		63 15/16" (1624)	35 5/16" (897)
56 btm		26" (660)	38 1/8" (969)		23 5/16" (592)