

# Vivid Windows

## Installation Instructions

---

**ABSTRACT:** Please read these instructions in their entirety before beginning to install your Vivid Window product. These installation instructions demonstrate the installation of a Vivid window in new wood frame construction using an industry approved water management system. For installation using other construction methods, such as remodeling, replacement, and recessed openings refer to the latest version of ASTM E2112, "Standard Practice for Installation of Exterior Windows, Doors and Skylights", for installation suggestions [www.astm.org](http://www.astm.org).

Regional standard practices, environmental conditions, and codes may vary and supersede the procedures contained within. The responsibility for compliance is yours: the installer, inspector, and owner(s).

The English language version of this instruction is the official version and shall take precedence over any translation.



These instructions are relevant for the following product types:

- Vivid Casement
- Vivid Casement Picture
- Vivid Direct Glaze
- Vivid Awning

# Table of Contents

Hazards and Warnings.....	2	Preparing the Window.....	6
Protective Films.....	3	Mounting Flange Installation.....	6
What is Included in the Job Box.....	3	Through Jamb Installation.....	9
Installer and Builder Information.....	4	Structural Bracket Installation.....	13
After Market Products.....	4	Exterior Sealing and Flashing Details.....	16
Tools and Supplies Needed.....	4	Flashing Window Installations.....	16
Installing the Window.....	5	Insulating and Sealing the Installation.....	16
Rough Opening Prep.....	5		

## Hazards and Warnings

### **WARNING!**

Do **NOT** lift or move without proper equipment. Read, understand, and follow all lift equipment manufacturers' instructions and safety information.

### **WARNING!**

This product can expose you to chemicals including titanium oxide, which is known to the state of California to cause cancer. For more information, go to [www.P65Warnings.ca.gov](http://www.P65Warnings.ca.gov).

### **WARNING!**

This product can expose you to chemicals including methanol, which is known to the state of California to cause birth defects or other reproductive harm. For more information, go to [www.P65Warnings.ca.gov](http://www.P65Warnings.ca.gov).

### **WARNING!**

Older homes may contain lead-based paint, which may be disturbed when replacing windows or performing renovations. Consult state or local authorities for safe handling, disposal, or abatement requirements. For information, go to [www.epa.gov/lead](http://www.epa.gov/lead).

*NOTE: Please consult with local waste management authorities regarding proper disposal and/or recycling of all waste materials generated during installation, including any product being replaced, packaging materials, and other waste.*

### **WARNING!**

Always practice safety! Wear the appropriate eye, ear, and hand protection, especially when working with power tools.

### **CAUTION!**

**Wear gloves and protective clothing** when handling the frame components. Some high-density fiberglass surfaces are not coated and can leave splinters in bare skin.

## Protective Films

Some products feature a clear protective film adhered to the glass surfaces to protect them from construction debris, dust, dirt, stucco, etc. When construction is complete, simply peel the film off and dispose of it with other construction debris.

### IMPORTANT

Do not use a razor blade to remove the protective film. Do not use a pressure washer to clean debris from the film. The film should be removed within nine months (typical) of application.

The use of high absorption coatings and tints, Neat+® coated glass, LoE-189® and other exposed Low-E coatings could affect adhesion and reduce the amount of time allowed to remove the film. Please refer to the [manufacturer's website](#) and [bulletin](#) for more information on the physical properties and usage of the protective film.

### IMPORTANT

**DO NOT** place suction cups over seams in the protective film.

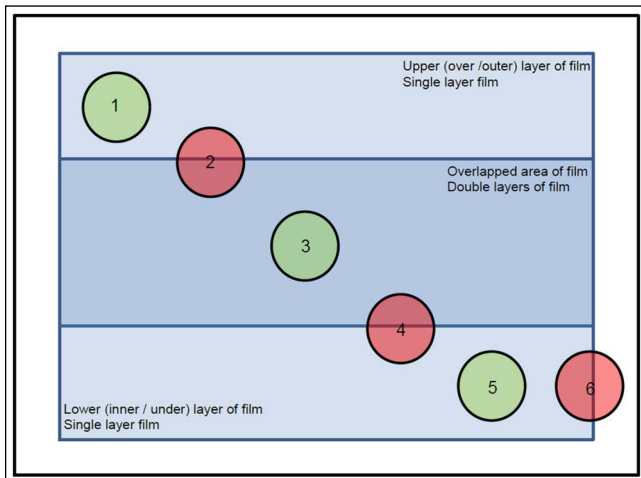

Figure 1 Do not put suction cups on seams or edges

## What is Included in the Job Box

Refer to the content list included in your job box for specific items that are included with your order. Sealants, hardware, fasteners, and many installation related parts are included with the window. See [Tools and Supplies Needed on page 4](#) for other items you will need to successfully install your Vivid window.

### Parts Included in Job Box

*NOTE: Parts are configuration dependent and may not be provided if they are not required. Extras may also be provided in some cases. Part or Kit descriptions may be generic, not including handing or color. Refer to Report Runner in Job Box for full descriptions.*

- **Vivid Casement:** Crank Handle (1), Crank Cover (1), Lock Handle (1), Lock Cover (1)
- **Vivid Awning:** Crank Handle (1), Crank Cover (1), Lock Handle (2), Lock Cover (2)
- **Through Jamb Installation:** Through jamb installation fasteners
- **Masonry Installation:** Structural brackets with fasteners

# Installer and Builder Information

- Always provide a copy of these instructions for the current homeowner.
- Plan sizing of rough opening and clearance from exterior finishing systems to allow for normal materials shrinkage or shifting (e.g. wood structure with brick veneer; allow adequate clearance at the sill). Failure to do so can void the Marvin warranty coverage.
- Refer to the Technical Installation Specifications section for technical specifications regarding the installation of this product. These installation requirements as well as the details in the section must be followed to achieve the advertised Performance Grade (PG) rating of this product.
- It is the responsibility of the builder, installer, and subcontractors to protect the interior and exterior of windows or doors from contact with harsh chemical washes, construction material contamination and moisture. Damage to glazing, hardware, weather strip and cladding/wood can occur. Protect with painters tape and/or protective sheathing as required. Follow all guidelines regarding material use, preparation, personal safety and disposal.
- Contact your Marvin supplier if you have any questions regarding product and materials used in manufacturing or questions on replacement parts.
- Please refer to the PDF version of this instruction for further information regarding best practices installer and builder information, code, and other legal requirements. The PDF version is the official document of record.

## After Market Products

Alterations to Marvin products including window films, insulating or reflective interior window treatments or additional glazings can cause excessive heat buildup and/or condensation. They may lead to premature failures not covered under warranty by Marvin Windows and Doors.

Before purchasing or applying any product that may affect the installation or performance of Marvin windows or doors, contact the manufacturer of after-market product/glazings that are not supplied by Marvin and request written product use, associated warranties and damage coverage. Provide this information and warranties to the end user and/or building owner for future reference.

## Tools and Supplies Needed

- Safety glasses
- Hearing protection
- Level
- Square
- Hammer
- Shims
- 2" Roofing nails
- Insulation
- Tape measure
- Perimeter sealant
- Sill pan flashing
- Backing material (foam backing rod)
- Low expansion foam insulation
- **Installer supplied Rigid Head Flashing (Drip Cap)**
- Weather resistant barrier
- Drill/Driver
- #2 Phillips bit
- Concrete anchors
- T20 Torx bit (Through Jamb installation)

---

## Installing the Window



### WARNING!

Do NOT lift or move without proper equipment. Read, understand, and follow all lift equipment manufacturers' instructions and safety information.



### Seek Assistance

Some large windows and/or assemblies are very heavy. Avoid injury by getting help to lift and position the window into the rough opening.

### IMPORTANT

All images are for illustrative purposes only. Images are meant to enhance understanding and are not necessarily exact representations of your unit.

*NOTE: The installation methods in this instruction include:*

- [Mounting Flange Installation on page 6](#)
- [Through Jamb Installation on page 9](#)
- [Structural Bracket Installation on page 13](#)

## Rough Opening Prep

For step-by-step instructions on how to prepare an opening using Method A1 using a TYPE III flash pan, refer to Rough Opening Prep instructions titled "Window Rough Opening Prep and Flashing Method A1-Membrane Drainage System". Refer to ASTM E2112-07 for other rough opening preparations that are more appropriate for your situation.

Using a smartphone or similar device, scan the QR code or click [here](#) to view these instructions.



## Preparing the Window

1. Inspect unit for any hidden damage and report immediately to your Marvin representative. Provide the customer service number etched on one of the top corners of the glass. See [Figure 2](#).

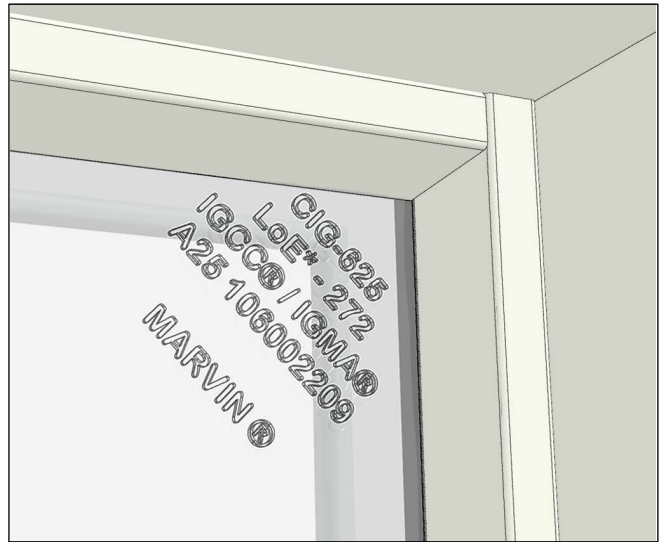

Figure 2

## Mounting Flange Installation

1. Check the sill for level and adjust if necessary. See [Figure 3](#).

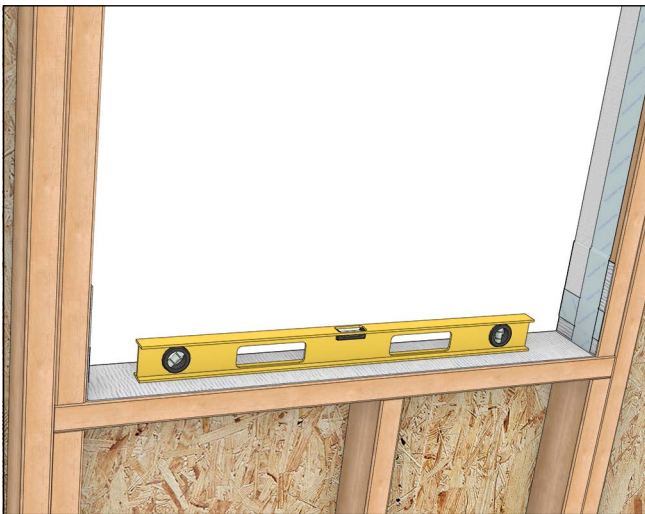

Figure 3

### IMPORTANT

When using drywall return (or equivalent) at the sill greater than 1/2" thickness, you will need to shim beneath the sill to avoid interference with interior covers.

2. Rough openings (RO) should be 1/2" (13) higher and 1" (25) wider than the outside measurement of the frame. (1/2" (13) on each side of the frame). See [Figure 4](#).

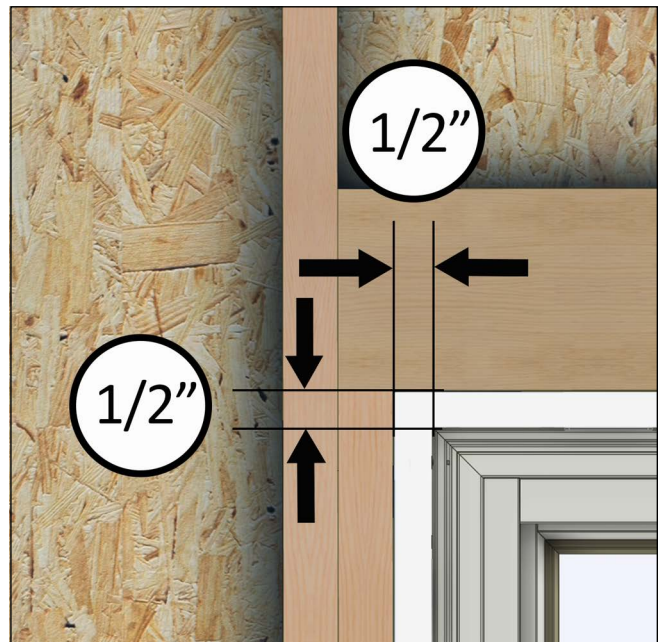

Figure 4

# ⚠ CAUTION!

If the previous conditions are not met, the installer must take corrective actions to alter the opening(s) before proceeding. It is also essential that the sheathing be a solid surface to ensure that the unit can be secured firmly to the wall.

3. Starting 3/4" from the side, apply 1/4" to 3/8" bead of sealant. Do not apply sealant across the RO bottom. See Figure 5.

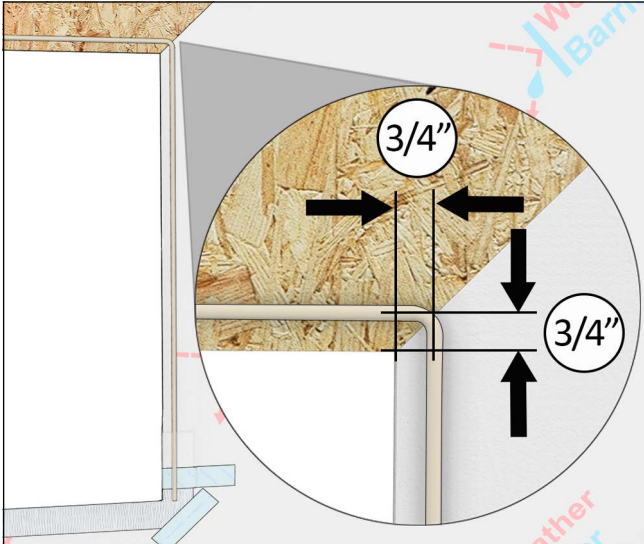

Figure 5

4. Place a discontinuous bead of sealant 1-3/8" from exterior edge of the RO sill stopping short of jamb edge for drainage. See Figure 6.

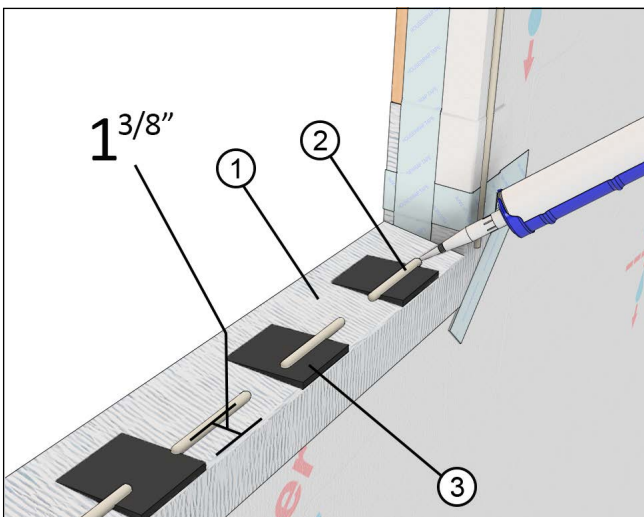

Figure 6

1	Sloped sill
2	Sealant
3	Shim(s)

5. Center the window in the opening. Level at the sill and plumb the frame (interior/exterior). Shim under the sill to bring to level, if necessary. See Figure 7.



Figure 7

6. Once level, tack the jamb mounting flange with 2" roofing nails within 4" from the head jamb. See Figure 8.



Figure 8

7. From the interior, shim about 4" from the bottom to square the unit in the opening. Take diagonal measurements of the window. When equal, the window is square in the opening. Adjust the shims until the unit is square in the opening. See Figure 9.



Figure 9

8. Once square, fasten the lower corners of the mounting flange and check for square. See Figure 10.



Figure 10

9. Complete shimming using shims at the spacing shown and at every through jamb screw location if applicable. Measure at head jamb, center of unit, and sill to make sure all dimensions are equal. If they are not, you will have to adjust the shims accordingly. See Figure 11.

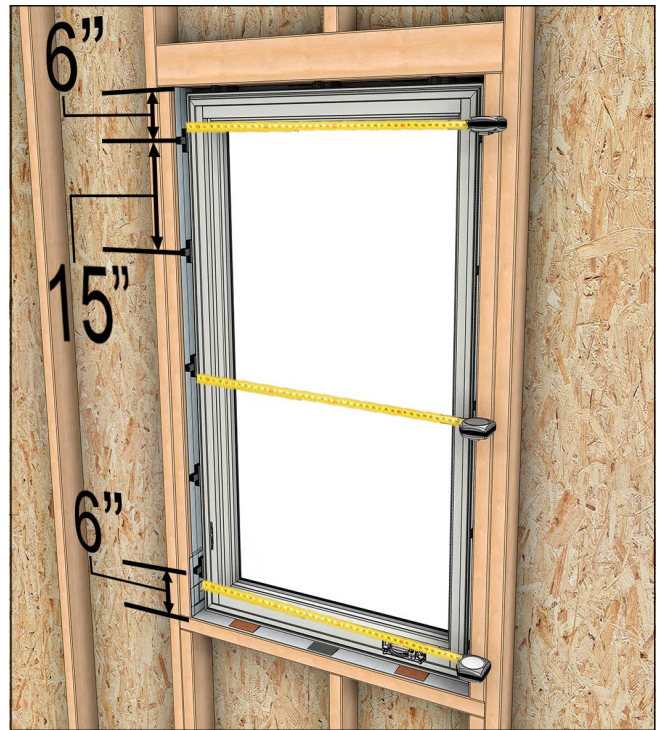

Figure 11

## ⚠ CAUTION!

Proper shimming is extremely important. Under-shimming or over-shimming will result in bowed jambs and or head jamb. Both conditions can contribute to improper window operation

10. Complete fastening of the mounting flange around the perimeter of the unit with 2" roofing nails, 4" from each corner and spaced every 6"- 8" on center.

11. Once the unit is square and plumb in the opening, operate the sash (on operable units) to make sure it is operating properly. If not, you may have to make some adjustments to the shims. For more information refer to [Adjusting the hinge arms and/or centering sash on page 17](#).



## Through Jamb Installation

1. Carefully remove all covers starting at head jamb, then sill, and lastly jambs. A small pry bar may be necessary for removal. See [Figure 12](#).

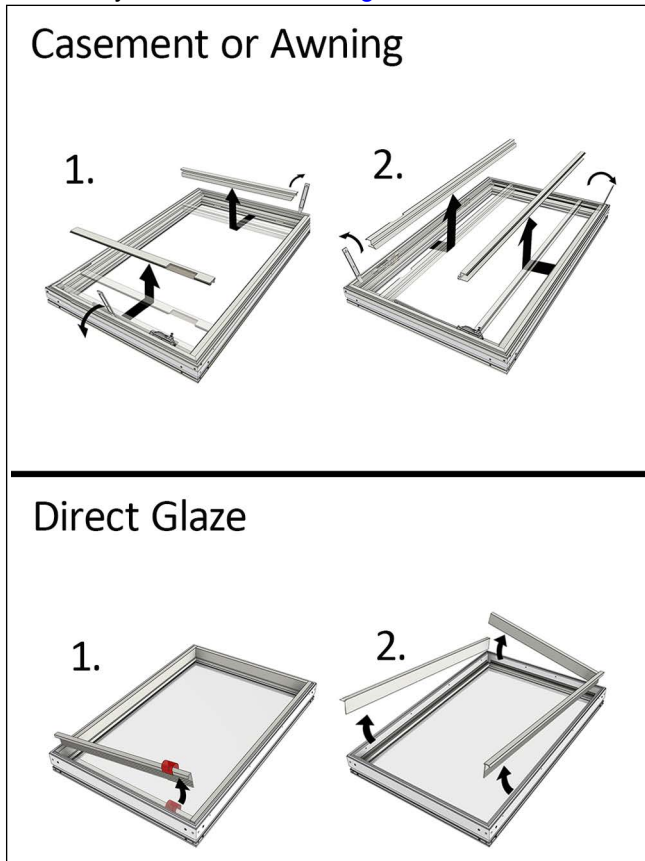

Figure 12

2. Check the sill for level and adjust if necessary. See [Figure 13](#).



Figure 13

## IMPORTANT

When using drywall return (or equivalent) at the sill greater than 1/2" thickness, you will need to shim beneath the sill to avoid interference with interior covers.

3. Center the window in the opening. Level at the sill and plumb the frame (interior/exterior). Shim under the sill to bring to level, if necessary. See [Figure 14](#).



Figure 14

## IMPORTANT

Shims are required at every installation hole.

4. After unit is level, insert shims near the top of each jamb and fasten using the supplied T20 #8 x 3" through pre-drilled holes. See Figure 15.



Figure 15

5. Shim about 4" from the bottom of each jamb to square the unit in the opening. Take diagonal measurements of the window. When equal, the window is square in the opening. Adjust the shims until the unit is square in the opening. See Figure 16.



Figure 16

6. Complete fastening and shimming at the spacing shown and at every screw location if applicable. Measure at head jamb, center of unit, and sill to make sure all dimensions are equal within 1/16". If they are not, adjust the shims accordingly. See Figure 17.

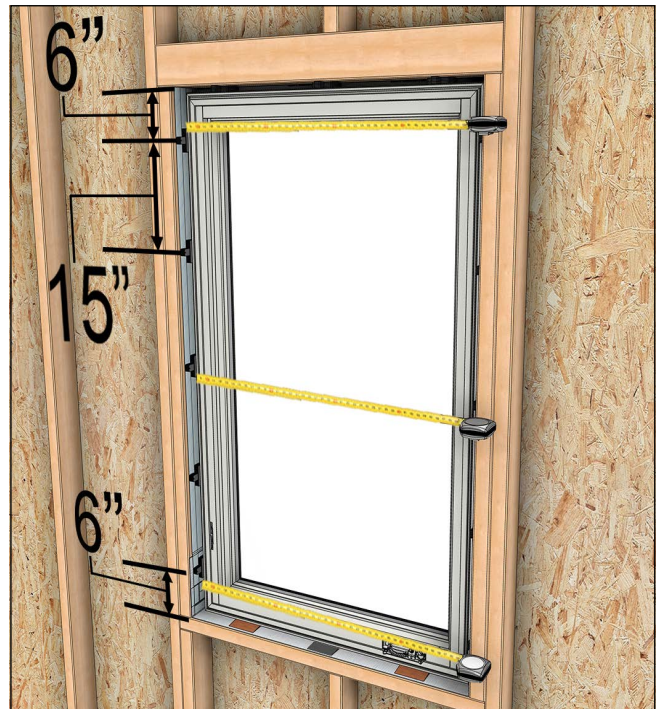

Figure 17

7. **Direct Glaze:** Replace covers. See Figure 18

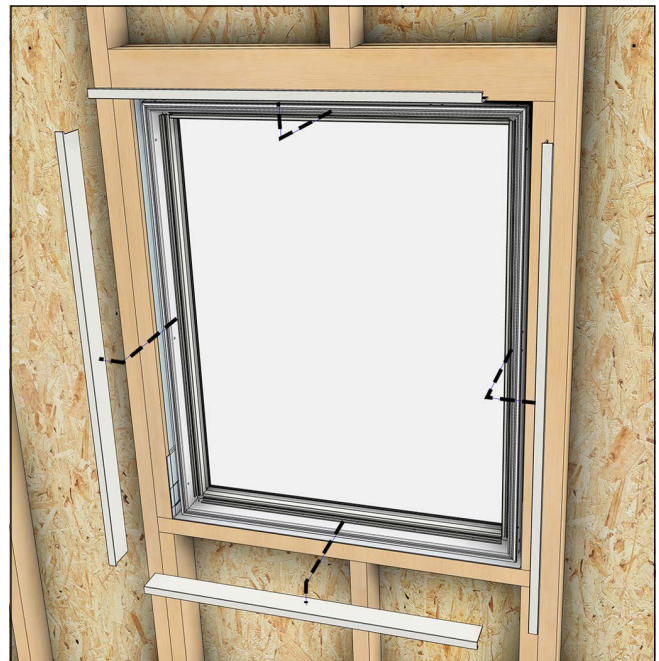

Figure 18

## IMPORTANT

Neglecting to install Direct Glaze screw covers at this stage may result in drywall or jamb extension obstruction preventing installation of the screw covers later.

**8. Casement/Awning:** Remove the top tie bar housing screws (A). See Figure 19.

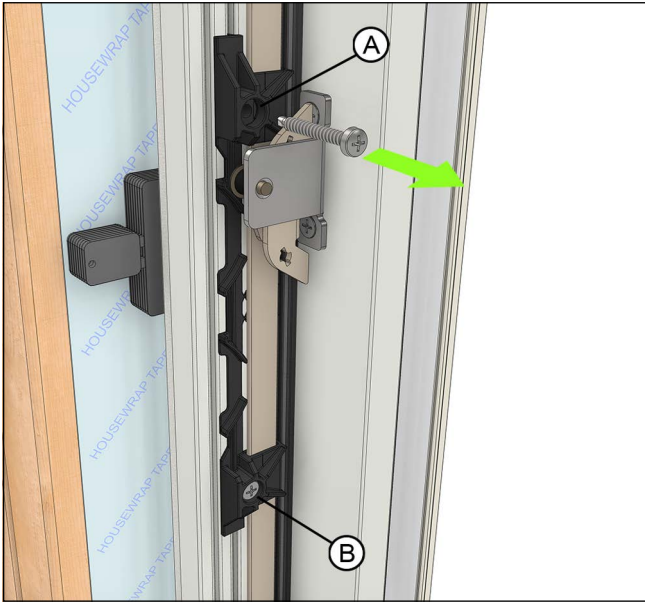

Figure 19

**9. Casement/Awning:** Drill holes through the frame with 5/32" drill bit at holes (A locations) with tie bar screw locations. See Figure 20.

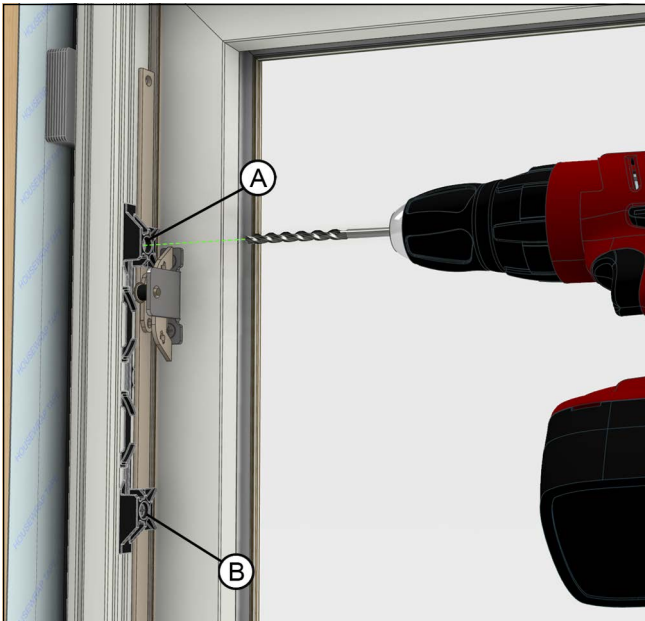

Figure 20

**10. Casement/Awning:** Add shims and fasten using through jamb installation screws at each (A) location, do NOT OVER TIGHTEN. Repeat steps at each (B) location. See Figure 21. Make sure unit is level, square, and plumb. Adjust shimming if necessary.

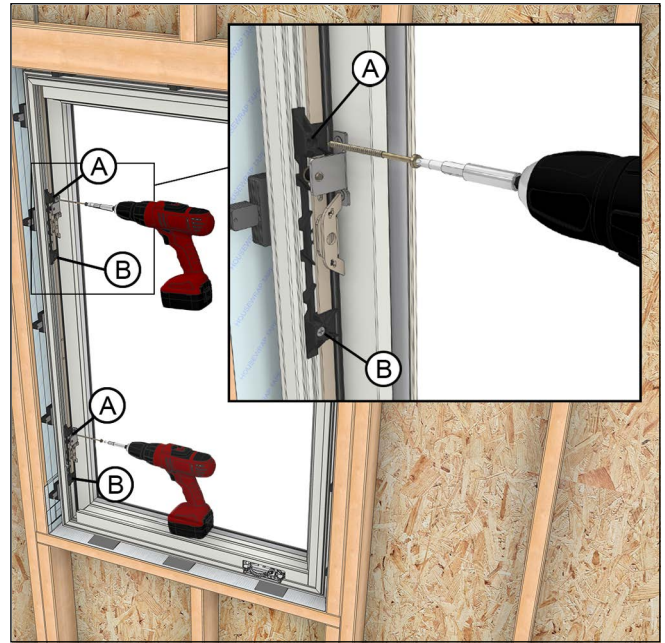

Figure 21

**11. Casement/Awning:** Replace covers. See Figure 22 and Figure 23. Ensure the covers are seated behind the weather strips. See Figure 24.



Figure 22



Figure 23

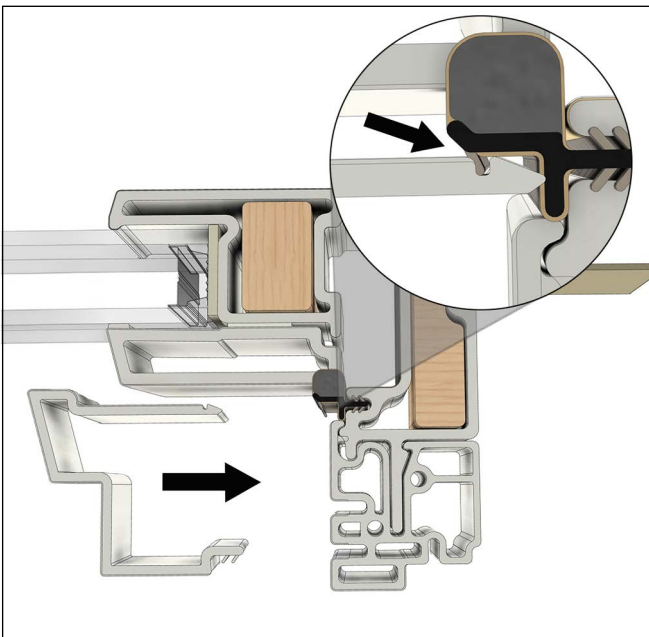

Figure 24

12. Once the unit is square and plumb in the opening, operate the sash (on operable units) to make sure it is operating properly. If not, adjust shims and installation screws as needed.

## Structural Bracket Installation

1. Attach structural brackets around the frame at the spacing shown in [Figure 25](#) using two of the provided #7 x 1/2" screws and fastening through the designated holes ([Figure 26](#)). Bracket needs to be attached while flush to the t-slot. [See Figure 27](#).

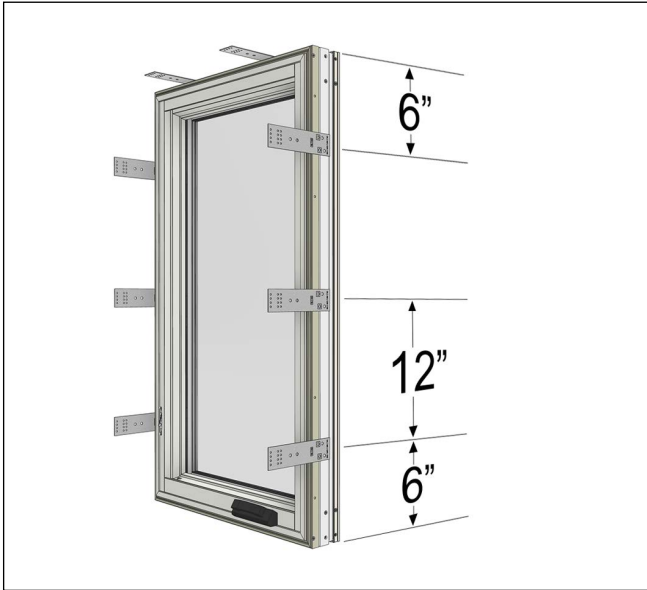

Figure 25

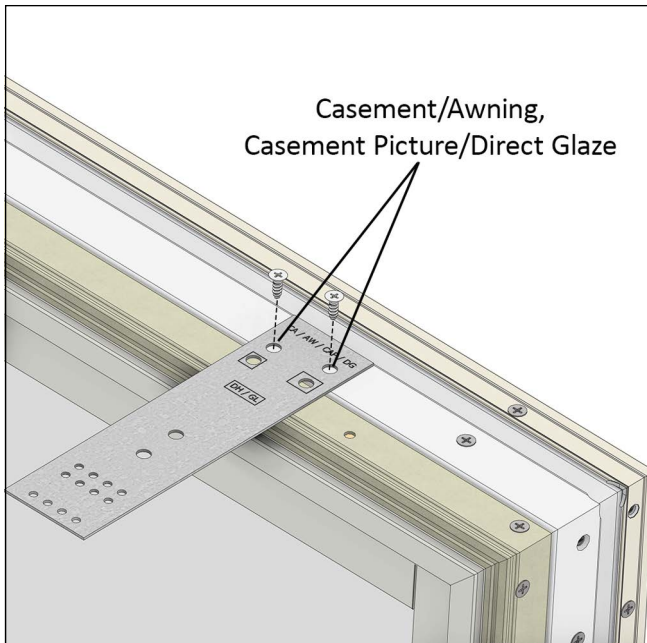

Figure 26

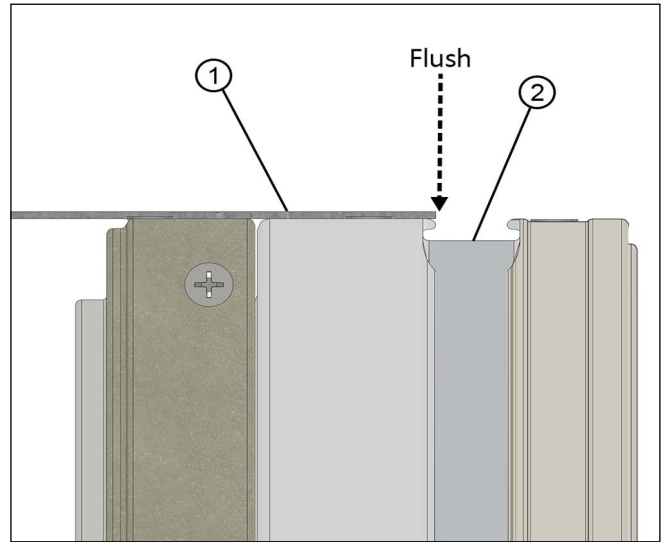

Figure 27

### IMPORTANT

Using screws other than the ones provided can lead to punctures and compromise performance of the product.

2. The Masonry Openings (MO) should be 1/2" (13) wider and 1/4" (6) higher than the outside measurement of the frame and casing. [See Figure 28](#).

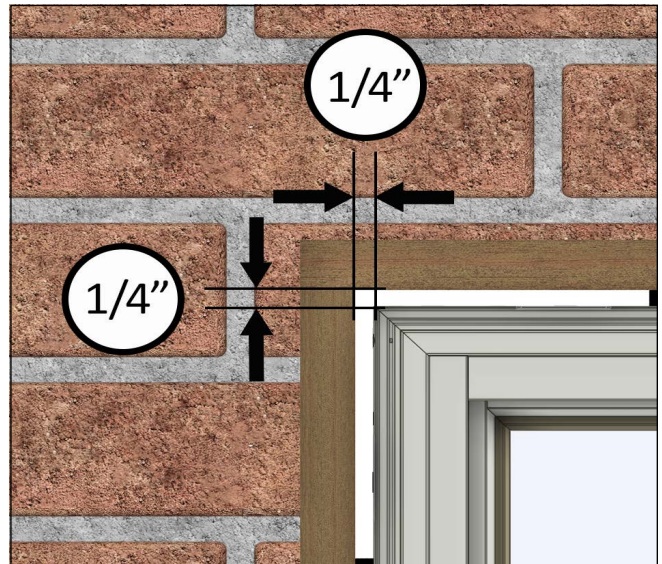

Figure 28

3. On standard wood frame construction with brick veneer, make sure there is at least 1/2" (13) between the bottom of the window sill (or eventual placement of the window) and the top row of brick to avoid "brick bind". See Figure 29.

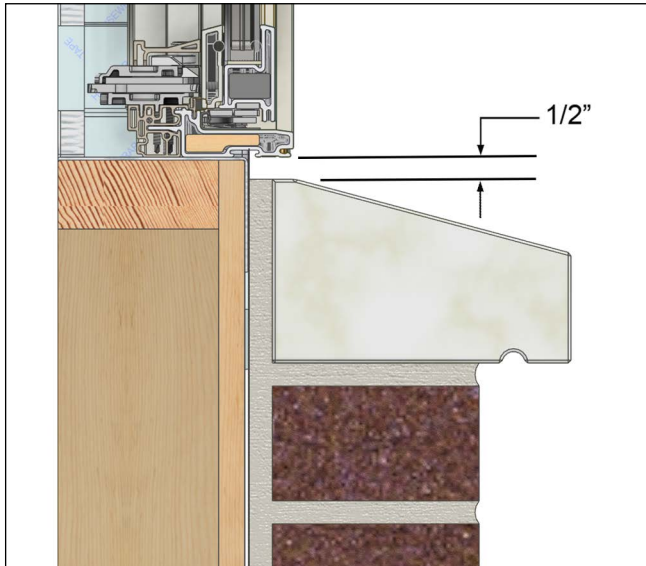

Figure 29 Avoid brick bind, maintain 1/2" gap

4. Check the sill for level and adjust if necessary. See Figure 30.

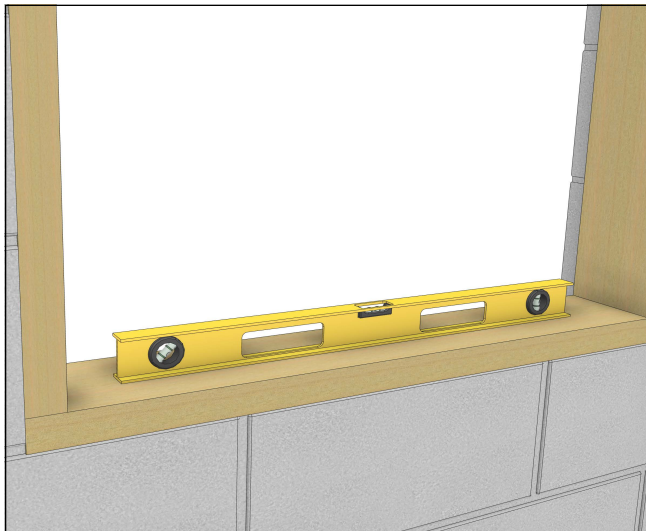

Figure 30

5. Place a discontinuous bead of sealant 1-3/8" from exterior edge of the RO sill stopping short of jamb edge for drainage. See Figure 31.

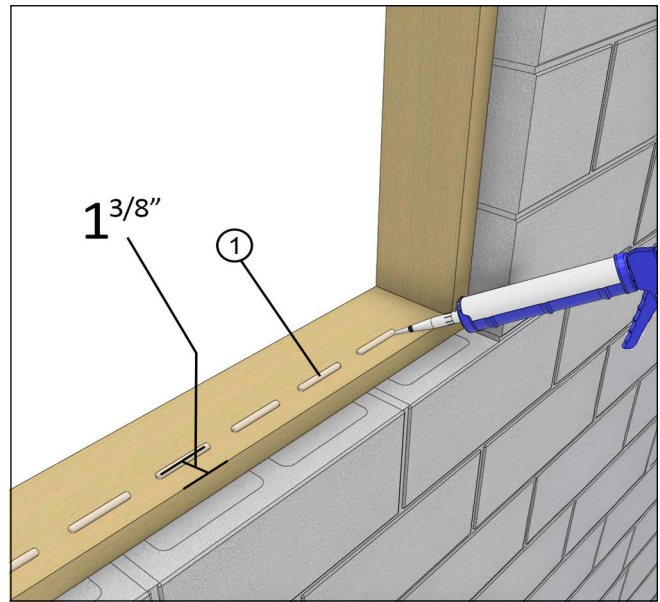

Figure 31

1	Sealant
---	---------

6. Center the window in the opening. Level at the sill and plumb the frame (interior/exterior). See Figure 32.

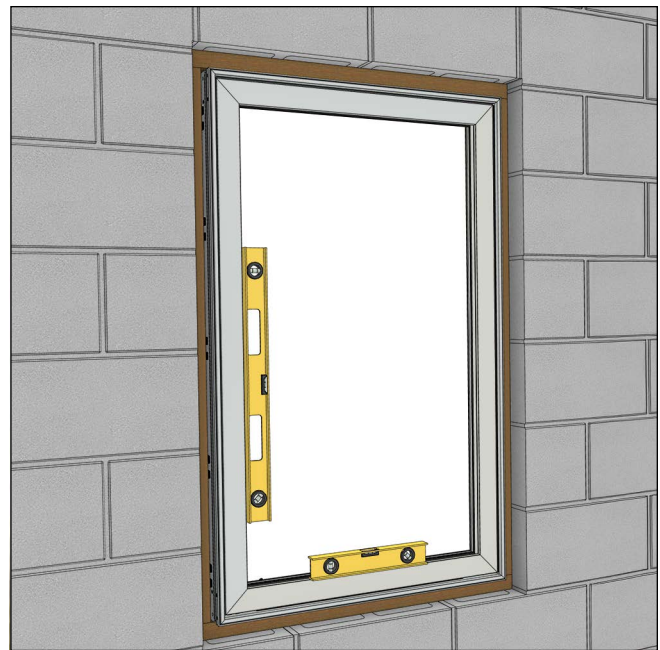

Figure 32

7. From the interior, shim about 4" from the bottom and top to square the unit in the opening. Take diagonal measurements of the window. When equal within 1/16", the window is square in the opening. Adjust the shims until the unit is square in the opening. See Figure 33.



Figure 33

9. Measure at the head jamb, mid-height, and sill to make sure all dimensions are equal within 1/16". If they are not, adjust the shims accordingly. See Figure 35.

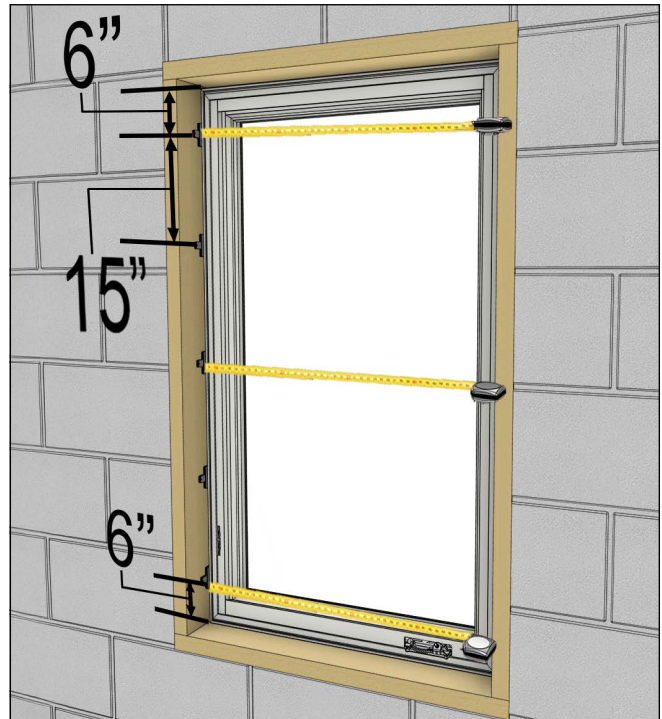

Figure 35

8. Bend brackets around framing member and attach with the #8 x 1-5/8" screws. Angle screws approximately 15° away from the window. Always shim above or below brackets. Add fasteners through the holes shown on Casement/Awning products as well. See Figure 34.

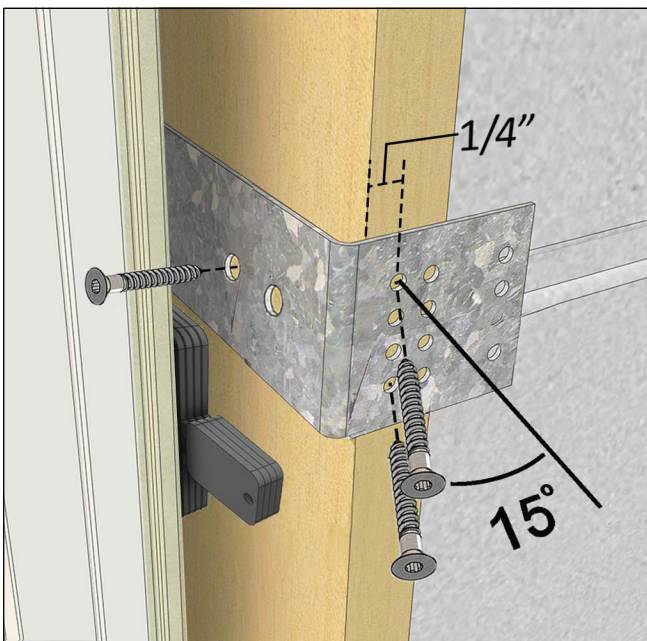

Figure 34

# Exterior Sealing and Flashing Details

## Flashing Window Installations

1. Flash the installation in a weather board fashion. For step-by-step instructions refer to Marvin.com for instructions titled "Window Rough Opening Prep and Flashing Method A1-Membrane Drainage System"

Using a smartphone or similar device, scan the QR code or click [here](#) to view these instructions.



## Insulating and Sealing the Installation

### IMPORTANT

Do not install drywall over the interior frame cover. This will hinder the ability to remove the cover later. When applying sealant between the cover and drywall, use a paintable caulk.

1. Insert backer rod around the perimeter near the exterior. Fill the opening cavity with low expansion foam. Finish by applying an interior bead of sealant as an interior moisture barrier. Use backer rod if needed. See [Figure 36](#).

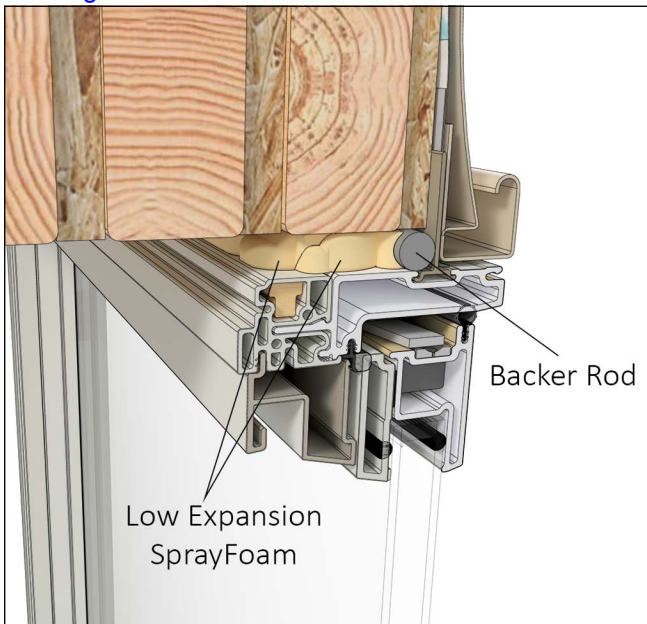

Figure 36

2. At the exterior, once the exterior finish such as siding or brick veneer is installed, apply a bead of sealant between the finish and the frame exterior along the sides. Apply additional beads approximately 1"-2" (25-51) at the ends on top of the head jamb flashing. Use a backer rod when necessary. See [Figure 37](#).

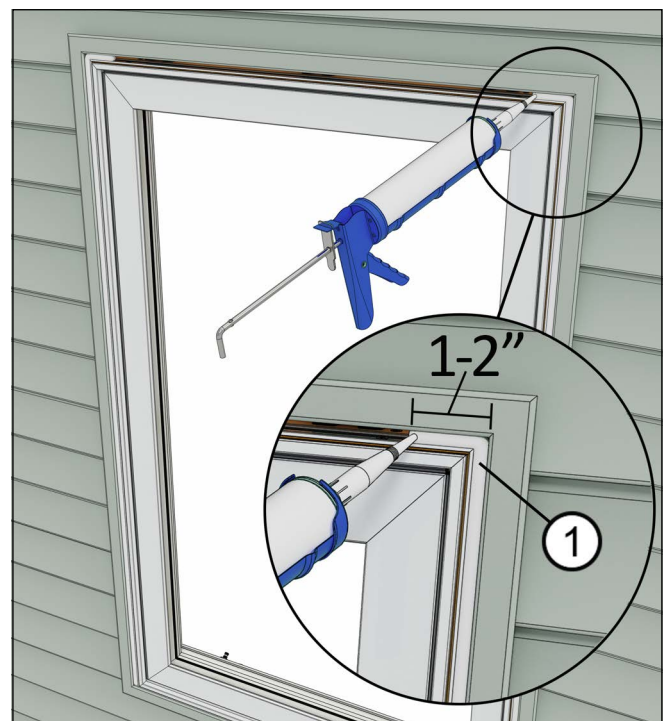

Figure 37

1	Sealant
---	---------

## ! CAUTION!

Perimeter sealant must be Grade NS Class 25 per ASTM C920 and compatible with the window product and the finished exterior(s) of the building. Using improper sealant could result in sealant failure causing air and water infiltration.



# Final Steps and Adjustments

## Shipping Block Removal

1. On Casement/Awning units, open the sash and remove the shipping blocks located on the exterior lock-side. See Figure 38.

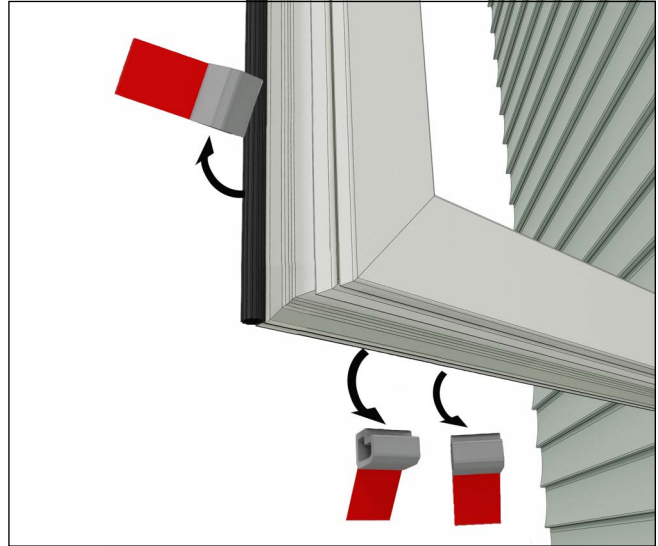

Figure 38

## Adjusting the hinge arms and/or centering sash



On operating units, one way to make sure that the unit is installed square is to check the reveal (gap) between the operating sash and the frame. An even reveal around the entire sash generally means a squarely installed unit and will ensure smooth operation.

Adjust top and bottom hinges using the tool shown below to achieve an even reveal.

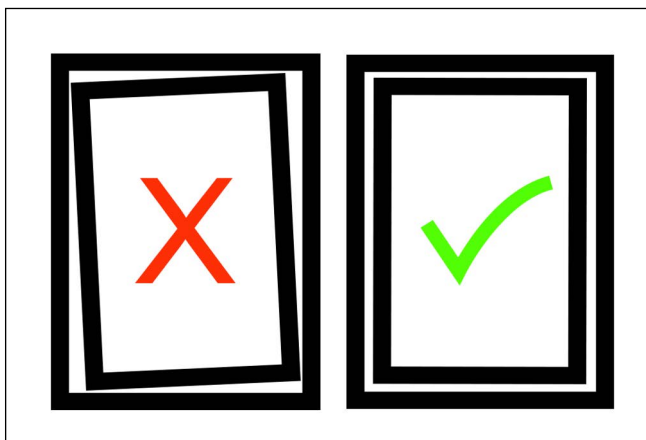

Figure 39

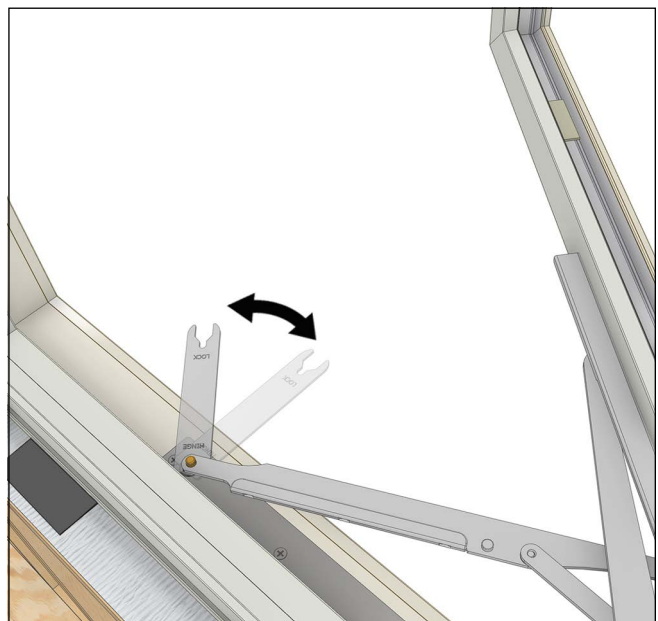

Figure 40

# Technical Installation Specifications

The following details are specified for proper installation and for the unit to meet the advertised design pressure (DP) rating.

- Rough Opening Width: 1/4" - 1" (6-25) wider than window/door frame outside measurement.
- Rough Opening Height: 1/4" - 1/2" (6-13) higher than window/door frame outside measurement.
- Masonry Opening Width: 1/4" - 1/2" (6-13) wider than window/door frame outside measurement.
- Masonry Opening Height: 1/8" - 1/4" (3-6) higher than window/door frame outside measurement.

## ATTENTION

**Architectural Detail Manual Specifications:**

Rough Opening: Width 1" (25); Height 1/2" (13).

Masonry Opening: Width 1/2" (13); Height 1/4" (6).

- The panning must drain water to the exterior of the cladding OR the exterior surface of a concealed weather resistive barrier.

## ! CAUTION!

Be aware that the use of sill pans and other barriers will decrease the rough opening height clearance. Adjust opening dimensions accordingly.

- The panning system used in these instructions is one component in a structure's overall water management system. It should be used in conjunction with an appropriate drainage plane compatible with the exterior cladding.
- Flashing materials must comply with ASTM E2112 and be compatible with all materials used in installation including panning systems, air barriers and building papers, sheathing, and the window unit.
- Properly flash and/or seal all windows at the exterior, perimeter.
- Sealants used for installation must be Grade NS Class 25 per ASTM C920 and compatible with the building exterior, window exterior surface, and flashing/water management materials.
- Optional foams used for installation must be low expansion only. Foam and foam application must comply with ASTM E2112.

- For units with flat casing install with installation brackets, structural masonry brackets, or jamb screws.
- Shims 4" - 6" (102-152) from each corner on jambs and head jambs. Install additional shims at 15" (381) on center and at all locking points. always shim at the check rails and meeting stiles.
- Do not use chemically treated products for shim material.
- Fasteners penetrating chemically treated lumber must be a minimum of 0.90 oz/ft<sup>2</sup> zinc hot dipped galvanized or stainless steel type 304 or 316.
- The window frame must not come into direct contact with chemically treated wood products.